

Instruction Manual

DuraVision® FDF4627W-IP

Color LCD Monitor

Software Version 4.1



Important

Please read this Instruction Manual, the Installation Manual and the Setup Manual carefully to familiarize yourself with safe and effective usage.

-
- For the latest product information including the User's Manual, refer to our web site:

<http://www.eizoglobal.com>

About this manual

	Setup Manual	Describes precautions and setup processes from network camera connection to camera image display.
	Instruction Manual (this manual)	Describes operation of network cameras and live image screen menus, etc.
	Installation Manual	Describes network camera registration and function setup, monitor system setup, etc.

* For the Instruction Manual (this document) and Installation Manual of the software version you are using, please refer to our web site. To view PDF files, you will need to install Adobe Acrobat Reader.
<http://www.eizo.com/support/db/products/manual/FDF4627W-IP#tab03>

This product has been adjusted specifically for use in the region to which it was originally shipped. If operated outside this region, the product may not perform as stated in the specifications.

No part of this manual may be reproduced, stored in a retrieval system, or transmitted, in any form or by any means, electronic, mechanical, or otherwise, without the prior written permission of EIZO Corporation. EIZO Corporation is under no obligation to hold any submitted material or information confidential unless prior arrangements are made pursuant to EIZO Corporation's receipt of said information. Although every effort has been made to ensure that this manual provides up-to-date information, please note that EIZO monitor specifications are subject to change without notice.

Notice for this monitor

Cleaning

Attention

- Chemicals such as alcohol and antiseptic solution may cause gloss variation, tarnishing, and fading of the cabinet or panel, and also quality deterioration of the image.
- Never use any thinner, benzene, wax, and abrasive cleaner, which may damage the cabinet or panel.

Note

- The optional ScreenCleaner is recommended for cleaning the cabinet and panel surface.

The stains on the cabinet and panel surface can be removed by moistening part of a soft cloth with water.

To use the monitor comfortably

- An excessively dark or bright screen may affect your eyes. Adjust the brightness of the monitor according to the environmental conditions.
- Staring at the monitor for a long time tires your eyes. Take a 10-minute rest every hour.

CONTENTS

Notice for this monitor	3
Cleaning	3
To use the monitor comfortably	3
CONTENTS	4
Chapter 1 Product overview	5
1-1. System Configuration	5
Chapter 2 Turning On / Off the Power	6
● To turn on the power	6
● To turn off the power	6
Chapter 3 Operating the System	7
3-1. Remote Control	7
3-2. Live Image Screen	8
● Basic menu operations.....	9
3-3. Changing Over Screen Layout and Displayed Pages.....	12
● To change over the screen layout	12
● To change over the page displayed on the screen.....	13
3-4. Turning Smart Functions On / Off.....	14
3-5. Controlling Network Cameras	15
● Before operation.....	15
● To Operate network cameras.....	16
3-6. Adjusting Screen Brightness	18
3-7. To switch among input signals	18
Chapter 4 Troubleshooting.....	19
4-1. No picture	19
4-2. Imaging problems	19
4-3. Other problems	20

Chapter 1 Product overview

This color LCD monitor can display images from up to 16 network cameras*1.

*1 A type of camera which converts images into network signals and transmits the signals.

1-1. System Configuration

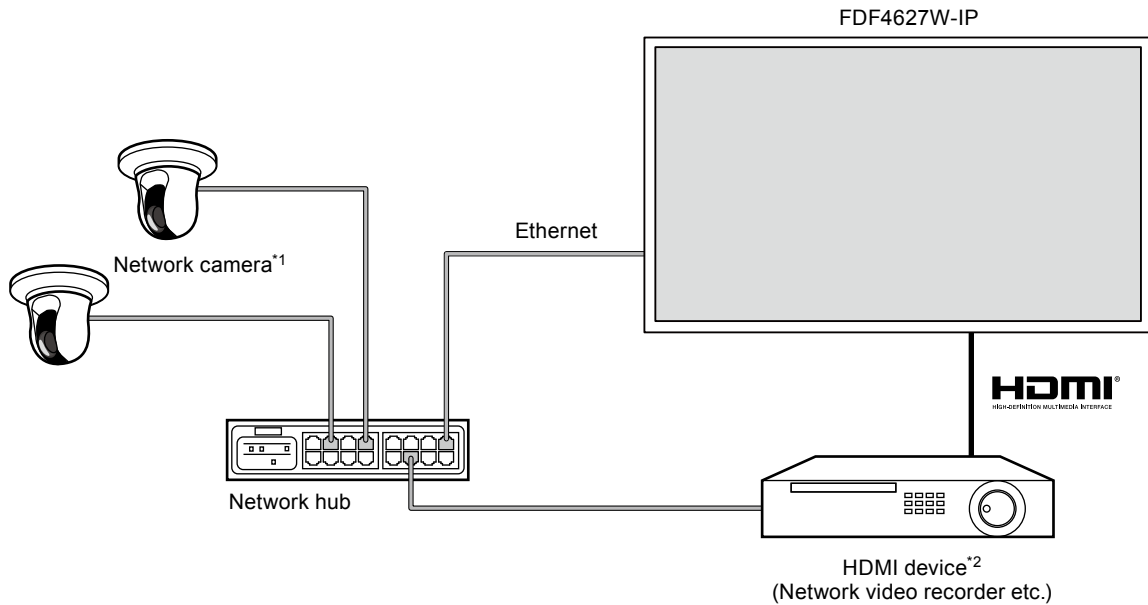

*1 Up to 16 network cameras can be registered.

*2 Use an HDMI device (e.g. network video recorder) if necessary.

Chapter 2 Turning On / Off the Power

● To turn on the power

1. Turn on the main power switch on the back of the monitor.

The main power switch is turned on when factory default settings are configured.

2. Press on the front of the monitor or POWER on the remote control.

The power indicator lights up blue and the live image screen is displayed.

(For details on the live image screen, refer to [“3-2. Live Image Screen”](#) (page 8).)

Attention

- By default, it takes approximately one minute for the live image screen to be displayed after the power is turned on (A rotating bar indicating startup is displayed). Do not turn off the monitor during startup.
- When the monitor is started up for the first time, a menu for operating the monitor and network cameras is displayed.
- When no network camera is registered, a “Not Registered” message is displayed at the network camera image display area.

Note

- The time required to display the live image screen can be reduced (Quick Start) by changing the power-off status. For details, refer to the Installation Manual.

● To turn off the power

1. Press on the front of the monitor or POWER on the remote control.

Attention

- The power indicator flashes blue while the system is shutting down.
- The power-off status differs depending on the “Quick Start” setting. For details, refer to the Installation Manual.
 - When set to “On”: Part of the system remains running. (Power Indicator: Red)
 - When set to “Off”: The system is shut down completely (default setting). (Power Indicator: OFF)
- When turning off the main power of the monitor, follow the procedure below.
 1. If “Quick Start” is set to “On”, change the setting to “Off”.
 2. Press  on the front of the monitor or POWER on the remote control to turn off the power.

The system is shut down and the power indicator turns off.
 3. Turn off the main power switch.
- Turning off the main power of the monitor before the system completely shuts down may cause equipment damage.
- Use the remote control within the range illustrated in the diagram below.

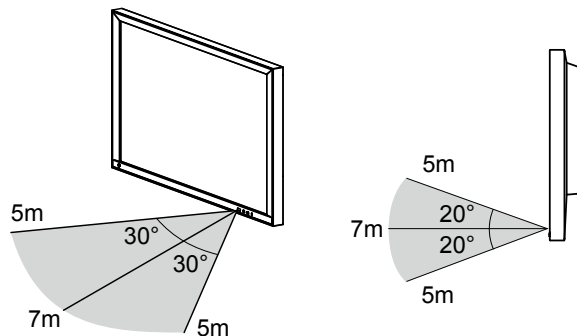

- When installing multiple monitors, leave sufficient space between each monitor so that only the intended monitor will be operated by the remote control. Otherwise, all monitors that receive the remote control signal will operate accordingly.

Chapter 3 Operating the System

Each menu is operated using the remote control or a USB mouse.

This chapter describes operating the menus using the remote control. To operate menus when using a USB mouse, refer to each item. For details on connecting a USB mouse, refer to “Basic menu operations” (page 9).

3-1. Remote Control

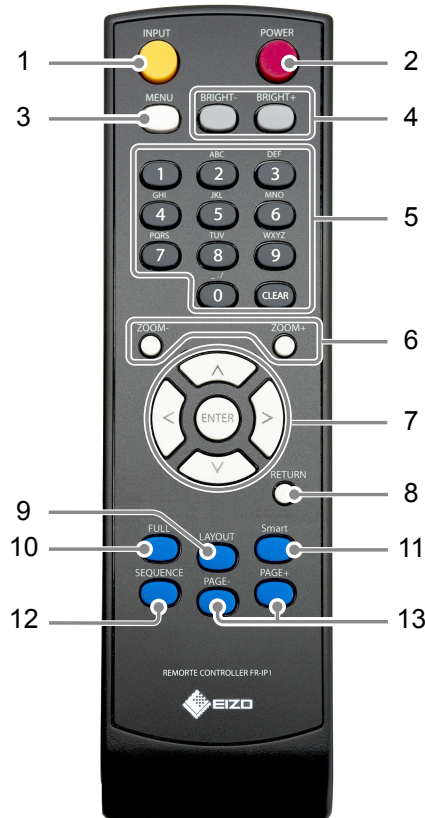

Name	Description
1. INPUT	Switches input signals for display.
2. POWER	Turns the power on or off.
3. MENU	Used to display / exit the monitor's Adjustment menu.
4. BRIGHT- / BRIGHT+	Adjusts the brightness of the monitor screen.
5. Number Buttons (0 to 9) / CLEAR	Used to enter numbers and letters.
6. ZOOM- / ZOOM+	Adjusts the network camera display magnification.
7. $\wedge / \vee / \langle / \rangle$, ENTER	Used to set and control (pan / tilt) network cameras, and configure system settings of the monitor.
8. RETURN	Returns to the previous menu status in menu operation.
9. LAYOUT	Changes the live image screen layout. Each time the button is pressed, the layout changes in the following order: 1 Screen → 3 Screens → 4 Screens → 9 Screens → 16 Screens → 8 Screens → 1 Screen.
10. FULL	Displays / hides the menu of the live image screen.
11. Smart	Turns the Smart function on or off.
12. SEQUENCE	Turns the sequential display of camera images on or off.
13. PAGE- / PAGE+	Changes the camera image page to display on the live image screen.

3-2. Live Image Screen

The live image screen is displayed when the monitor is turned on.

There are two states to the live image screen. Live image screen menu can be shown or hidden by pressing FULL.

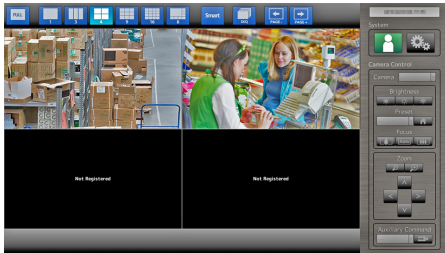

Live image screen
(camera images and menu)

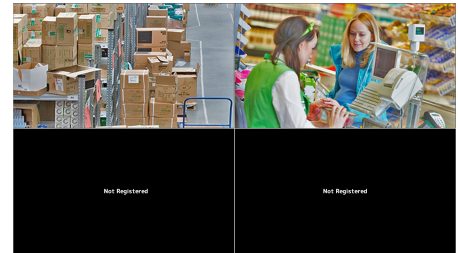

Live image screen
(camera images only)

Note

- You can also operate the live image screen from your Web browser. For information on operation from a Web browser, refer to the Installation Manual.
-

● Basic menu operations

The menu is used for operation and setting of network cameras and the monitor.

Live Image Screen

1. Display mode menu

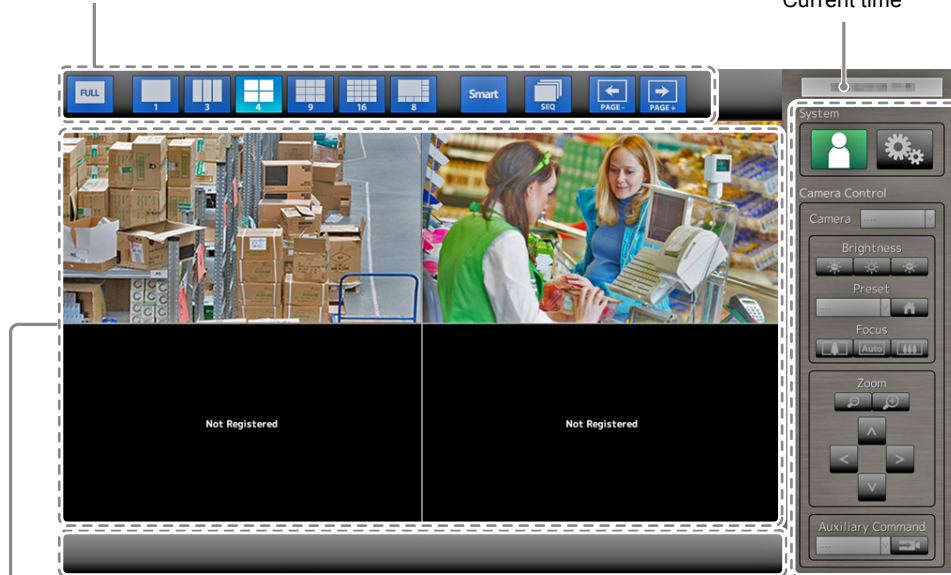

2. System setup menu / Camera control menu

Message display area
(Error messages such as on camera operations are displayed.)

Network camera image display area

- When no camera is registered, a "Not registered" message is displayed.
- When an input signal is not supported, a "Communication Error" message is displayed.

Attention

- When sequence display is enabled, the system setup menu and the camera control menu are inoperable.



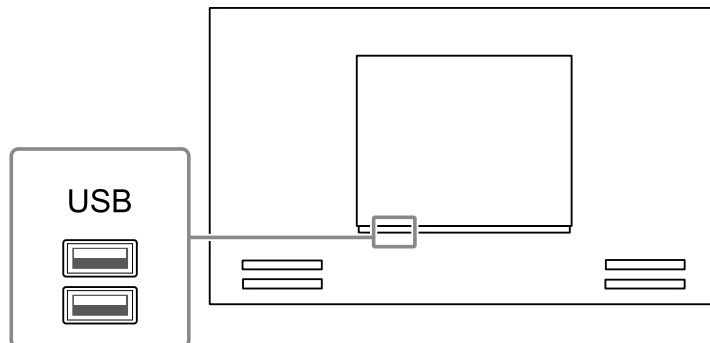

Note

- The displayed menus can be operated by remote control even if the menus on the live image screen are hidden.
- When using a USB mouse to operate the menu
 - Connect the mouse to the USB downstream port at the back of the monitor.

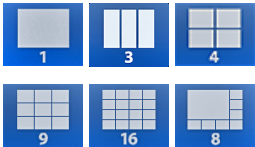

Display mode menu

Camera images displayed on the live screen can be operated.

Display mode menu	Remote control button	Description
	FULL	Displays / hides the menu of the live image display screen.
	LAYOUT	Changes the live image screen layout. Each time the button is pressed, the layout changes in the following order: 1 Screen → 3 Screens → 4 Screens → 9 Screens → 16 Screens → 8 Screens → 1 Screen.
	Smart	Turns the Smart function* ¹ on or off. * ¹ Improves the image visibility.
	SEQUENCE	Turns the sequential display* ² of camera images on or off. * ² Changes over the displayed page at a set interval.
	PAGE- / PAGE+	Changes the camera image page to display on the live image screen.

System setup menu / Camera control menu

The system settings menu is used for logging into and configuring the system.

The camera control menu controls network cameras from the monitor in the camera operation menu.

Item	Operation method
To select an item	Press the \wedge / \vee / \lt / \gt buttons.
To confirm a selected item	Press ENTER.
To change a setting	<p>With setting buttons: Press ENTER. (Excluding zoom in / out and position adjustment)</p> <p>With list box:</p> <ol style="list-style-type: none"> 1. Press ENTER. The list box is highlighted in green. 2. Select the setting with \wedge or \vee. 3. Press ENTER.
To return to the previous menu level	<p>Press RETURN.</p> <p>Note</p> <ul style="list-style-type: none"> • When canceling a setting change in process, press RETURN.

Entering characters

1. Press ENTER.

The text field is highlighted in green.

2. Press the number buttons (0 to 9).

Press a button consecutively to change over to the character next in order. For the order of character entry, refer to the table shown below.

Button	Input characters									
0	0	-	_	:	.	/	(space)			
1	1									
2	a	b	c	A	B	C	2			
3	d	e	f	D	E	F	3			
4	g	h	i	G	H	I	4			
5	j	k	l	J	K	L	5			
6	m	n	o	M	N	O	6			
7	p	q	r	s	P	Q	R	S	7	
8	t	u	v	T	U	V	8			
9	w	x	y	z	W	X	Y	Z	9	

To enter a new character, press >.

To delete a character, press CLEAR.

3. Press ENTER.

Note

- Entering network addresses
Network address text fields are separated by [.] (a period mark).
 - When a three-digit number is entered, the cursor automatically moves to the next entry position.
 - When entering a two-digit or one-digit number, press > to move to the next entry position.
- When using a USB mouse
 - When you enter a period “.”, the cursor moves to the next entry position.
 - To enter characters, click “Keyboard” on the character entry screen. Then click the keys on the displayed keyboard to enter characters.

Attention

- The remote control cannot be used to select the character entry screen keyboard.

Attention

- The operable range of the menu differs according to the level of the user accessing this product. There are three user levels: “LIVE”, “CAMERA CONTROL” and “ADMIN”. The range of operation for each level is shown below.

(√: Operable, -: Inoperable)

Operation Level	Display mode menu	System setup menu		Camera control menu
		Login operation	System settings	
LIVE	√	√	-	-
CAMERA CONTROL	√	√	-	√
ADMIN	√	√	√	√

- When the power is turned on and after logoff, the user level is “LIVE”.
- For information on setting user levels, refer to the Installation Manual.

3-3. Changing Over Screen Layout and Displayed Pages

● To change over the screen layout

Changes the number of camera images to display on the live image screen.

Procedure

1. Press LAYOUT on the remote control.

Each time the button is pressed, the screen layout changes over. When using a USB mouse, the screen layout changes by selecting the display screen layout icon.

Example: When the camera image is 16:9

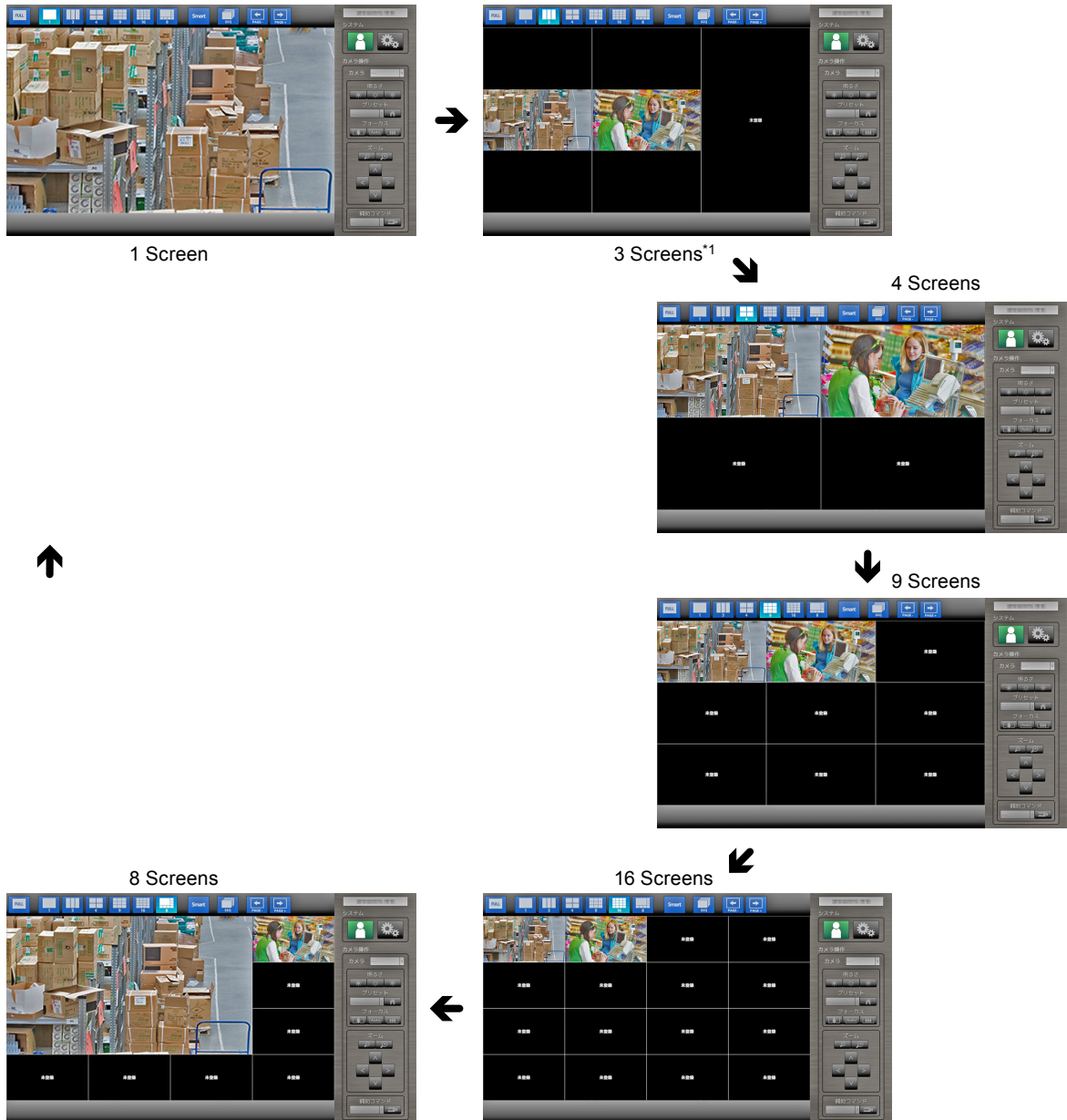

*1 Display set to the aspect ratio mode "Aspect" when the camera image is 16:9 (For details, refer to section "2-4. Setting the Camera Image Display Position" in the Installation Manual).

Attention

When displaying the image layout in three screens:

- Only the Axis network camera displays portrait images maintaining their vertical and horizontal image aspect ratios. To display images, the network camera setting is required. For details on the settings, refer to the network camera User's Manual.

Note

- The selected network camera image is displayed in one screen by selecting the live image screen network camera image and pressing LAYOUT on the remote control.
-

● To change over the page displayed on the screen

Except for when the screen layout is 16 Screens, camera images are displayed by changing over pages.

Pages can be changed over either manually or automatically at a set interval (sequential display).

Changing pages manually

Procedure

1. Press PAGE- or PAGE+ on the remote control.

Each time the button is pressed, the page displayed on the screen changes over. When using a USB mouse, select PAGE- or PAGE+ in the display menu.

Example: 4 Screens layout

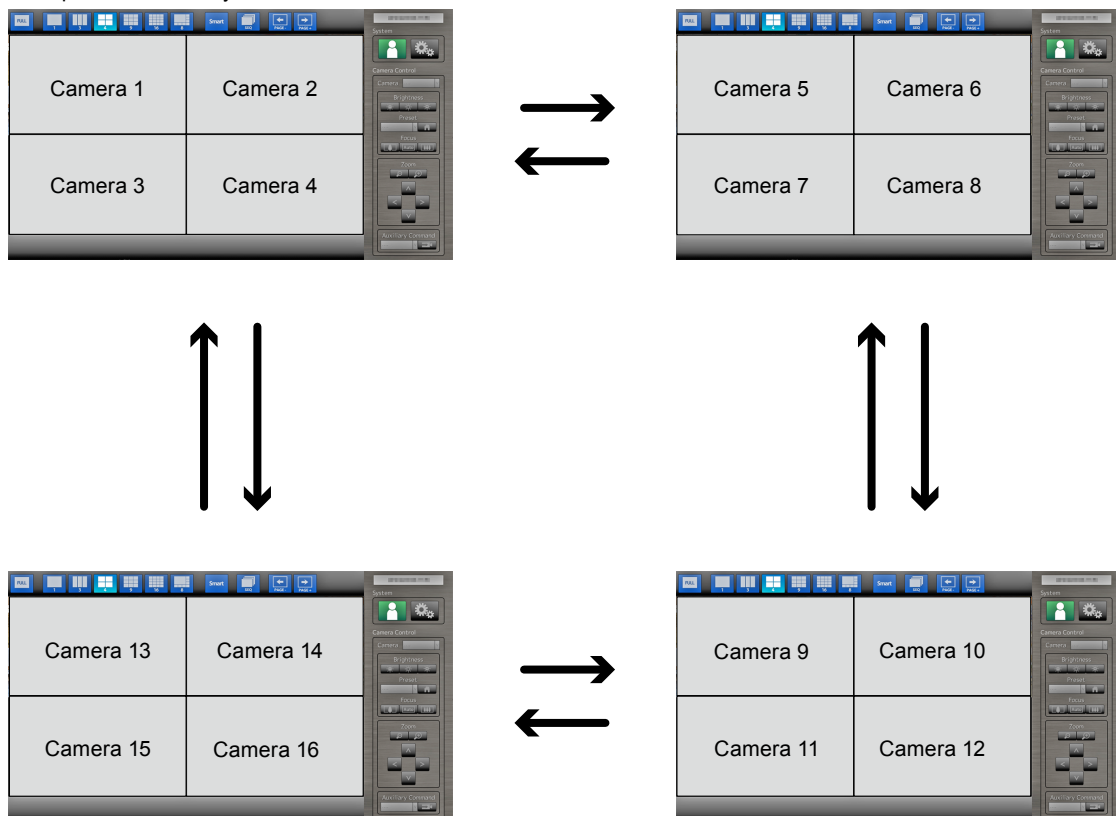

Changing pages automatically (Sequential display)

Procedure

1. Press SEQUENCE on the remote control.

Pages displayed on the screen are changed over automatically at a specified interval.

Note

- The interval for page changeover can be changed (default setting: 5 sec). For information on how to change the display interval, refer to the Installation Manual.
- To stop sequential display, press SEQUENCE again.

Attention

- During sequential display, camera control is disabled and the setting screen cannot be displayed. The sequential display must be stopped in order to operate cameras or display the setting screen. For information on how to display the setting screen, refer to the Installation Manual.
 - Only pages registered for the network camera are displayed in the sequence display. Pages not registered with the camera will not be displayed.
-

3-4. Turning Smart Functions On / Off

Enable or disable settings of Smart Functions. Using Smart Functions improves the camera image visibility.

Procedure

1. Press Smart on the remote control.

Each time the button is pressed, Smart Functions are turned on or off.

Note

- For information on how to configure Smart Functions, refer to the Installation Manual.
-

3-5. Controlling Network Cameras

● Before operation

Network camera control is allowed only when the level of the user accessing this product is “CAMERA CONTROL” or “ADMIN”.

Be sure to log in to the system with a user account of either of these levels.

Procedure

1. Select  (Login) under “System”.
The login screen is displayed.

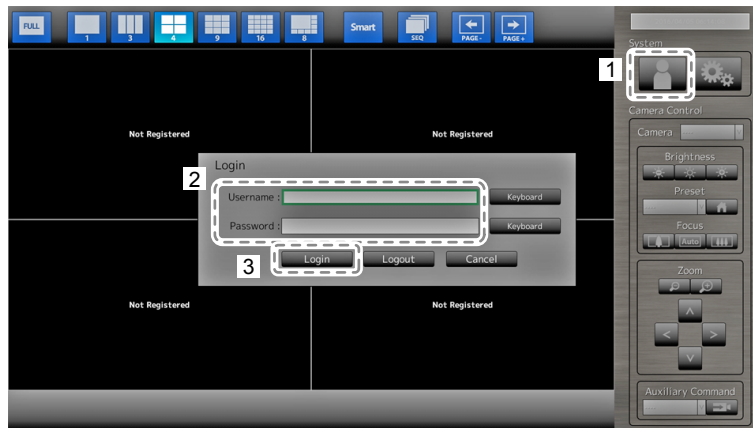

2. Enter a username and a password.
3. Select “Login”.
The display returns to the live image screen.
4. Press RETURN on the remote control.
The system frame is selected (highlighted in green).

Note

- For information on how to enter characters, refer to [“Entering characters” \(page 11\)](#).
- The following user information is set by default:
 - Username: “admin”
 - Password: “admin”
 - User Level: “ADMIN”
- For information on how to configure users, refer to the Installation Manual.
- It is recommended that you log out after completing operations, so as to prevent a third party from operating the camera or altering the settings.

Attention

- When the monitor power is turned off while the user is logged in, the user is logged out from the system automatically. In such a case, you will also be logged out from the web browser.
-

● To Operate network cameras

Procedure



1. Select the camera control menu.

1. Press RETURN.
2. Select the camera control menu using \wedge or \vee , then press ENTER.

2. Select the network camera to operate.

1. Check that "Camera" is selected and press ENTER.
2. Select a network camera displayed in the live image screen using \wedge or \vee , then press ENTER. The frame around the selected camera image become bold.
3. Press RETURN.

3. Select a function to use.

1. Select a function to use using \wedge or \vee .
2. Press ENTER.

4. Operate the functions.







Attention

- Depending on the type of the network camera you are using, some functions may not be available.

Note

- To select a network camera to operate, use the numerical buttons on the remote control. Also, click the USB mouse to select an the image in the live image screen.
 - The position at which images in the live image screen are displayed can be changed. For details, refer to the Installation Manual.
-

Brightness / Preset / Focus







Function	Detail
Brightness	<p>Adjusts the brightness of the network camera.</p> <ol style="list-style-type: none"> Select the setting button and press ENTER. <p> : Each time ENTER is pressed, the image becomes darker.</p> <p> : Returns the brightness to the default setting.*1</p> <p> : Each time ENTER is pressed, the image becomes brighter.</p>
Preset	<p>Moves the camera orientation to the position registered in advance.</p> <ol style="list-style-type: none"> Select the “Preset” list box and press ENTER. Select the preset number with \wedge or \vee and press ENTER. <p>Note</p> <ul style="list-style-type: none"> For information on registering a preset position, refer to the Installation Manual. To move the network camera orientation to the home position, select .
Focus	<p>Adjusts the network camera focus.</p> <ol style="list-style-type: none"> Select the setting button and press ENTER. <p> : Each time ENTER is pressed, the focus point moves closer.*2</p> <p> : Focuses automatically.*3</p> <p> : Each time ENTER is pressed, the focus point moves farther away.*2</p>

*1 Cannot be set if using a network camera for which “Protocol” is “ONVIF” or “AXIS.”

*2 If using a network camera for which “Protocol” is “ONVIF” or “AXIS,” the mode is switched to manual adjustment mode.

*3 If using a network camera for which “Protocol” is “ONVIF” or “AXIS,” the mode is switched to automatic adjustment mode.

Zoom / Position

Function	Detail
Zoom	<p>Adjusts the network camera display magnification.</p> <ol style="list-style-type: none"> Press ZOOM- / ZOOM+. <p> : Zooms out each time ZOOM- is pressed.</p> <p> : Zooms in each time ZOOM+ is pressed.</p>
Position	<p>Adjusts the shooting position of the network camera.</p> <ol style="list-style-type: none"> Press \lt / \gt / \wedge / \vee. <p>  : Adjusts the horizontal position (pan).</p> <p>  : Adjusts the vertical position (tilt).</p>

Auxiliary Command

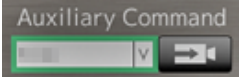
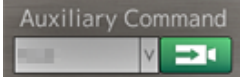
Function	Detail
Auxiliary Command	<p>Operates auxiliary functions for the network camera(s).</p> <ol style="list-style-type: none"> Select the list box for the “Auxiliary Commands”, then press ENTER.*1 Select the auxiliary command using \wedge or \vee, then press ENTER. <p> → </p>

*1 Auxiliary commands can be operated using only ONVIF specified devices.

Note

- When operating with a USB mouse, the network camera position can be adjusted automatically by clicking on a position in the image where you wish to set as the center of the image display (only supports Panasonic or AXIS network cameras equipped with pan, tilt, and zoom functions).

3-6. Adjusting Screen Brightness

Adjust the brightness of the monitor screen by changing the brightness of the backlight (light source at the back of the LCD panel).

Adjustable range

0 to 100

Procedure

1. Press BRIGHT- or BRIGHT+ on the remote control.
The brightness adjustment menu is displayed.



2. Set the brightness with BRIGHT- or BRIGHT+.
The menu disappears automatically after approximately five seconds.

3-7. To switch among input signals

Press INPUT on the remote control to change over the input signal.

When the signal is switched, the active input port name appears at the top right corner of the screen.

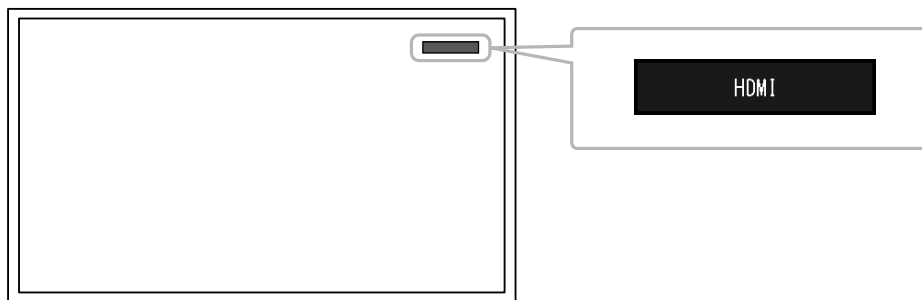

Note

- SIGNAL on the monitor also can change the input.
-

Chapter 4 Troubleshooting

4-1. No picture

Problem	Possible cause and remedy
1. No picture <ul style="list-style-type: none">Power indicator does not light.	<ul style="list-style-type: none">Check whether the power cord is connected properly.Turn the main power switch on.Press  on the front of the monitor or POWER on the remote control.Turn off the main power, and then turn it on again a few minutes later.
<ul style="list-style-type: none">Power indicator is lighting blue.	<ul style="list-style-type: none">Adjust the screen brightness (For details, refer to the Setup Manual).
<ul style="list-style-type: none">Power indicator is lighting blue. (for HDMI input)	<ul style="list-style-type: none">Check whether the HDMI cable is connected properly.Check whether the connected device is turned on.Pull out the HDMI cable and connect it again (For details, refer to the Setup Manual).

4-2. Imaging problems

Problem	Possible cause and remedy
1. The screen is too bright or too dark	<ul style="list-style-type: none">Adjust the screen brightness (For details, refer to the Setup Manual). (The LCD monitor backlight has a limited life span. When the screen becomes dark or begins to flicker, contact your local EIZO representative.)
2. Afterimages appear	<ul style="list-style-type: none">Afterimages are particular to LCD monitors. Avoid displaying the same image for a long time.
3. Green / red / blue / white dots or defective dots remain on the screen	<ul style="list-style-type: none">This is due to LCD panel characteristics and is not a failure.
4. Interference patterns or Pressure marks remain on the LCD panel	<ul style="list-style-type: none">Switch to the HDMI port and try displaying a white or black image on full screen. The symptom may disappear.

4-3. Other problems

Problem	Possible cause and remedy
1. Operation buttons on the front of the monitor do not work	<ul style="list-style-type: none">• Check whether the operation lock function is active (For information on how to release the lock, refer to the Installation Manual).
2. Buttons on the remote control do not work	<ul style="list-style-type: none">• Check whether the remote control is pointed to the signal receiving part.• Check for obstacles between the remote control and the signal receiving part.• Batteries are dead.• Check whether batteries are inserted correctly.
3. The mouse does not work	<ul style="list-style-type: none">• Check whether the USB cable is connected properly.• Pull out the USB cable and connect it again.• Check whether the mouse is directly connected to the monitor.
4. Remote control or mouse responses lag	<ul style="list-style-type: none">• Reduce the resolution and / or bit rate set for the network camera (For details, refer to the Installation Manual).
5. Network camera cannot be operated	<ul style="list-style-type: none">• The system is not logged in by a user with a camera operable level (For details, refer to the Installation Manual).• Network camera is inoperable during sequential display (For details, refer to the Installation Manual).
6. USB flash drive is not recognized	<ul style="list-style-type: none">• Check whether the USB flash drive is connected properly.• Take out the USB flash drive and insert it again.• Check whether the USB flash drive is directly connected to the monitor.

