

Installation Manual

DuraVision® FDF4627W-IP

Color LCD Monitor

Software Version 4.3

Thank you for purchasing our Color LCD Monitor.



Important

Please read this “Installation Manual”, the “Instruction Manual” and the “Setup Manual” carefully to familiarize yourself with safe and effective usage.

-
- For the latest product information including the “Installation Manual”, refer to our web site: <http://www.eizoglobal.com>
-



About this manual

	Setup Manual	Describes precautions and setup processes from network camera connection to camera image display.
	Instruction Manual	Describes operation of network cameras and live image screen menus, etc.
	Installation Manual (this manual)	Describes network camera registration and function setup, monitor system setup, etc.

This product has been adjusted specifically for use in the region to which it was originally shipped. If operated outside this region, the product may not perform as stated in the specifications.

No part of this manual may be reproduced, stored in a retrieval system, or transmitted, in any form or by any means, electronic, mechanical, or otherwise, without the prior written permission of EIZO Corporation. EIZO Corporation is under no obligation to hold any submitted material or information confidential unless prior arrangements are made pursuant to EIZO Corporation's receipt of said information. Although every effort has been made to ensure that this manual provides up-to-date information, please note that EIZO monitor specifications are subject to change without notice.

Notice for this monitor

About the Usage of This Product

This product is suited for displaying surveillance camera images.

This product has been adjusted specifically for use in the region to which it was originally shipped. If the product is used outside the region, it may not operate as specified in the specifications.

This product may not be covered by warranty for uses other than those described in this manual.

The specifications noted in this manual are only applicable when the following are used:

- Power cords provided with the product
 - Signal cables specified by us
-

Only use optional products manufactured or specified by us with this product.

About the LCD Panel

The LCD panel is manufactured using high-precision technology. Although, missing pixels or lit pixels may appear on the LCD panel, this is not a malfunction. Percentage of effective dots: 99.9994 % or higher.

Monitors should be set to a lower brightness to reduce changes in luminosity caused by long-term use and maintain a stable display.

When the screen image is changed after displaying the same image for extended periods of time, an afterimage may appear. Use the screen saver or power save function to avoid displaying the same image for extended periods of time. Depending on the image, an afterimage may appear even if it was displayed for a short period of time. To remove such a phenomenon, change the image or keep the power turned off for several hours.

The backlight of the LCD panel has a fixed lifetime. When the screen becomes dark or begins to flicker, please contact your local EIZO representative.

Do not press on the LCD panel or edge of the frame strongly, as this may result in display malfunctions, such as interference patterns, etc. If pressure is continuously applied to the LCD panel surface, the liquid crystal may deteriorate or the LCD panel may be damaged. (If the pressure marks remain on the panel, leave the monitor with a black or white screen. The symptom may disappear.)

Do not scratch or press on the LCD panel with any sharp objects, at this may result in damage to the LCD panel. Do not attempt to brush with tissues as this may scratch the panel.

About the Installation

When installing the monitor in a rack, ensure that there is adequate space around the sides, back and top of the monitor.

When the monitor is cold and brought into a room or the room temperature goes up quickly, dew condensation may occur on the interior and exterior surfaces of the monitor. In that case, do not turn the monitor on. Instead wait until the dew condensation disappears, otherwise it may cause some damage to the monitor.

If you place this product on a lacquer-coated desk, the color may adhere to the bottom of the stand due to the composition of the rubber. Check the desk surface before use.

About the Maintenance

Periodic cleaning is recommended to keep the monitor looking new and to prolong its operation lifetime (For details, refer to the Instruction Manual.).

Disclaimer

EIZO shall not be liable in any way to any person whatsoever for the occurrences described below.

1. Any incidental, special or consequential disruption or damage directly or indirectly arising in connection with this product.
2. Any loss, damage or cost resulting from misuse or neglect.
3. Any malfunction or failure occurring after unauthorized disassembly, repair or alteration regardless of its cause.
4. Any inconvenience, loss or damage caused by the inability to display images due to any reason or cause including malfunctions or failures in this product.
5. Any failure or consequential inconvenience, loss or damage due to malfunction or failure of a combined system that comprises this product and any third party products.
6. Any consequential claim for compensation or complaint based on privacy violation or any other reason by individuals or entities recorded in the surveillance images which are made public for/by whatever cause or used.
7. Any loss of registered data for whatever cause.

While this product displays camera surveillance images, the use of this product alone does not directly prevent crime.

Cautions for Network Use

Because this product is used by connecting to networks, the following risks apply

1. Leakage of information through this product.
2. Unauthorized operation of this product by a malicious third party.
3. Interference or suspension of the use of this product by a malicious third party.

In order to prevent the above described damage, it is the user's responsibility to implement adequate network security measures including the measures described below.

- Use this product with a safety-ensured network by using a firewall or other network security systems.
- Change the administrator password periodically.

CONTENTS

Notice for this monitor	3		
Disclaimer	4		
Cautions for Network Use	4		
CONTENTS	5		
Chapter 1 Product overview	6		
1-1. Features	6		
● LCD panel	6		
● Operation	6		
● Communication with network cameras	6		
● Compatible with Several Different Kinds of Network Cameras	6		
● Equipped with a Function that Improves the Quality of Surveillance Camera Images ...	6		
● System Control	7		
● Security	7		
● Support	7		
1-2. System Configuration	7		
1-3. Supported Network Cameras	8		
Chapter 2 Configuring from the monitor screen ...	9		
2-1. Before Configuration	9		
2-2. Setting Screen	10		
● Basic operations	10		
2-3. Setting Network Cameras	12		
● To automatically discover network cameras ...	12		
● To manually register network cameras	15		
● To set network camera functions	17		
2-4. Setting Display Positions of Camera Images	24		
2-5. Setting Visibility Optimizer Function	25		
2-6. Configuring System Settings	26		
2-7. Setting User Information	36		
● To register new user information	37		
● To change user information	38		
● To delete user information	39		
● Configuring Auto Login Settings	40		
2-8. Displaying Operation Logs	41		
● To display log data	41		
● To save log data	42		
Chapter 3 Configuring from a Web Browser ...	43		
3-1. Before Configuration	43		
3-2. Web Control Screen	44		
● Basic Operations	44		
3-3. Basic Information	45		
● System Information	45		
● System Status	45		
● Camera and Display Position / Date and Time Settings / Network Settings / Communication Settings	46		
3-4. Setting Network Cameras	47		
● To automatically detect cameras	47		
● Load camera information	49		
● Manual Registration of Cameras / Changing Camera Information	50		
● Deleting Camera Information	53		
● Save Camera Information	53		
3-5. Setting Display Positions of Camera Images	54		
● Setting Display Positions	55		
● Other Display Settings	56		
● Setting Visibility Optimizer function	57		
● Custom Screen Settings	58		
3-6. Configuring System Settings	59		
● Date and Time	59		
● Network Settings	62		
● Communication Settings	63		
● Other System Settings	64		
● Maintenance	65		
3-7. Setting User Information	71		
● Adding User Information	71		
● Changing User Information	72		
● To delete user information	72		
● Configuring Auto Login Settings	73		
3-8. Displaying Operation Logs	74		
● Displaying logs	74		
● Displaying the system log	74		
3-9. Setting the Live Image Screen	75		
● Live Image Screen Settings	76		
● System Status Settings	77		
Chapter 4 Troubleshooting	78		
4-1. Imaging problems	78		
4-2. Setting Problems	80		
Chapter 5 Reference	81		
5-1. List of setting items	81		
Chapter 6 Glossary	87		
Appendix	89		
Trademark	89		
License	90		
LIMITED WARRANTY	91		
Recycling Information	92		

Chapter 1 Product overview

This color LCD monitor can display images from up to 16 network cameras*1.

This manual describes network camera setup, monitor system setup and specifications, etc.

For information on setup, refer to “[Chapter 2 Configuring from the monitor screen](#)” (page 9) and “[Chapter 3 Configuring from a Web Browser](#)” (page 43).

*1 A type of camera which converts images into network signals and transmits the signals.

1-1. Features

● LCD panel

- 46.0" wide format LCD
- Supports a resolution of 1920 × 1080
- LCD panel with wide field of view adopted
VA LCD panel with 178° horizontal and vertical viewing angles
- LED backlight LCD panel
No mercury, a hazardous substance, is used.

● Operation

- Can be operated remotely with the remote control.
- Equipped with Easy Setup function
Necessary settings for setup can be performed with a wizard.

● Communication with network cameras

- Receives input video signals from network cameras.
 - Compatible with video compression formats H.264 and MJPEG.
 - Up to 16 network cameras can be registered and displayed.
 - Images from multiple network cameras can be displayed simultaneously (1- / 3- / 4- / 8- / 9- / 16- / custom screen display).
 - Network cameras can be controlled from the monitor.
 - Unicast and Multicast video signals can be displayed.
 - Camera image display positions can be switched while displaying the images.

● Compatible with Several Different Kinds of Network Cameras

- Compatible with ONVIF Profile S
- Panasonic and AXIS network cameras can be set using the manufacturer specific protocols.
(When connecting Panasonic or AXIS network cameras)

● Equipped with a Function that Improves the Quality of Surveillance Camera Images

- Provides display modes (DAY / NIGHT) suitable for surveillance camera images
- Equipped with EIZO original “Visibility Optimizer” technology
 - Outline Enhancer function
This function adjusts the perceived resolution of the images so that the blurs are reduced and images are displayed vividly and clearly.
 - Low-light Correction function
This function analyzes the image and corrects the brightness for each pixel to make dark area of images visible.
 - Noise Reduction function
This function reduces the amount of block noise that occurs due to video compression.

● System Control

- You can register a network camera and configure the live image screen using your web browser
- Possible to save and load the settings data
You can save the settings data to a USB storage device or to a PC and load the data.

● Security

- Alert display
You can have an alert displayed on the live image screen when communication with a network camera is lost.

● Support

- A 2-year long-term warranty for 24-hour continuous use

1-2. System Configuration

Communicating with network cameras, it can display video on the monitor, and operate cameras.

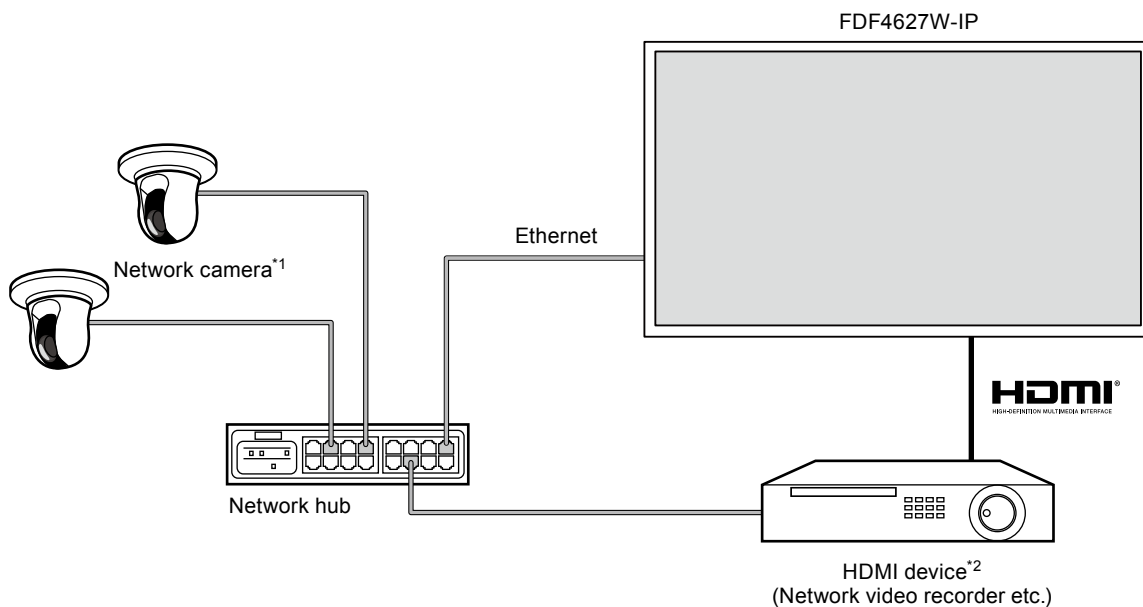

*1 Up to 16 network cameras can be registered.

*2 Use an HDMI device (e.g. network video recorder) if necessary.

1-3. Supported Network Cameras

This product supports the following network cameras:

- Panasonic i-pro series network cameras
- AXIS network camera
- ONVIF Profile S-compatible network cameras

Attention

- Supported network cameras vary depending on the monitor's software version. Check the software version of the monitor you are using, then check our website (<http://www.eizoglobal.com>) for details on supported network cameras. For information on how to check the software version, refer to "2-6. Configuring System Settings" (page 26).
- For installation and settings of network cameras, also check the network camera's manual.

Note

- You can access network camera images by specifying the URI to verify the network camera connections. For details, see "Manual Registration of Cameras / Changing Camera Information" (page 50).
-



Chapter 2 Configuring from the monitor screen

You can configure and operate network cameras from the monitor screen. To configure from your web browser, see “[Chapter 3 Configuring from a Web Browser](#)” (page 43). Operating and setting the monitor can be implemented by using either the Remote Control, or a USB mouse. To use a USB mouse, connect the mouse to the USB downstream port at the back of the monitor.

2-1. Before Configuration

To configure from the monitor screen, you need to be logged in to the system. Configuration of this product is allowed only by ADMIN level users. Be sure to log in to the system with a user account of this level.

Procedure

1. Press  on the front of the monitor or POWER on the remote control.
The power indicator lights up blue and the live image screen is displayed.
(For information on the live image screen, refer to the Instruction Manual.)
2. Select  (Login) under “System”.
The login screen is displayed.

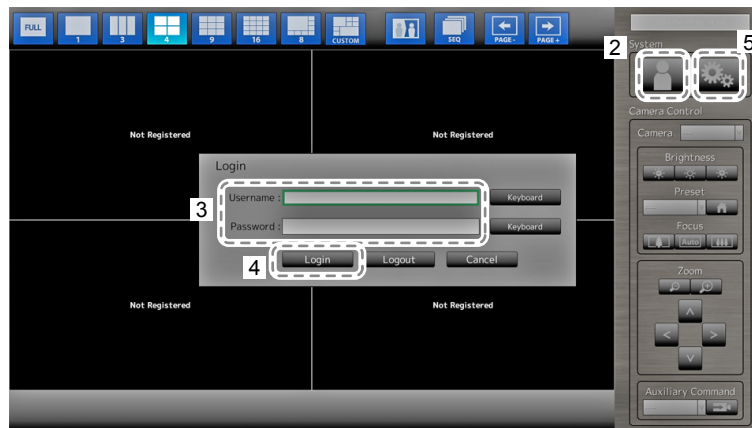

3. Enter a username and a password.
4. Select “Login”.
The display changes back to the live image screen.
5. Select  (Setting).
The setting screen is displayed.
(For information on the setting screen, see “[2-2. Setting Screen](#)” (page 10).)

Note

- See “[Entering characters](#)” (page 11) for the character entry method.
- The following user information is set by default:
 - Username: “admin”
 - Password: “admin”
 - User Level: “ADMIN”
- For information on user settings, see “[2-7. Setting User Information](#)” (page 36).
- It is recommended that you log out after completing the setup, so as to prevent a third party from operating the network camera or altering the settings.
- When the Auto Login settings are configured, you can log in to the system without the username and password. For details, see “[Configuring Auto Login Settings](#)” (page 40).

Attention

- When the monitor power is turned off while the user is logged in, the user is logged out from the system automatically. In such a case, you cannot display the web interface in your web browser.

2-2. Setting Screen

The setting screen is used for various settings such as network camera registration and monitor system settings.

● Basic operations

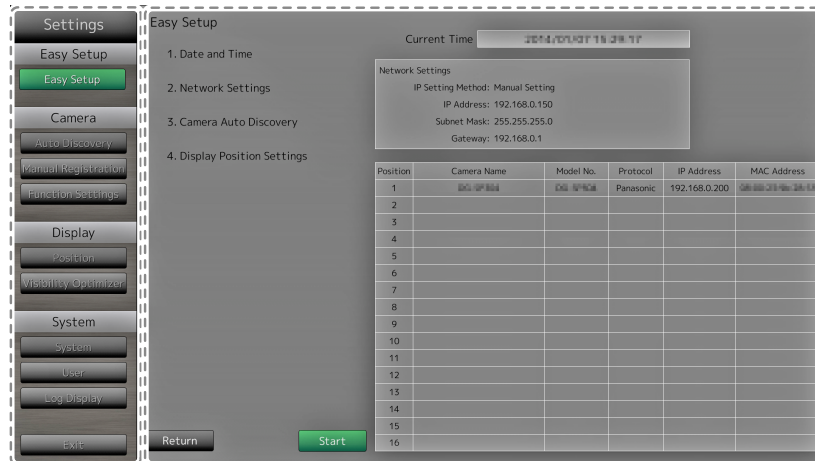

List of setting items

The setting screen of the selected item is displayed.

Item	Operation method
To select an item	Press the \wedge / \vee / \lt / \gt buttons.
To confirm a selected item	Press ENTER.
To change a setting	<p>With setting buttons: Press ENTER. (Excluding zoom in / out and position adjustment)</p> <p>With list box: 1. Press ENTER. The list box is highlighted in green. 2. Select the setting with \wedge or \vee. 3. Press ENTER.</p>
To return to the previous menu level	<p>Press RETURN.</p> <p>Note</p> <ul style="list-style-type: none"> • When canceling a setting change in process, press RETURN.
To exit the setting screen	<ol style="list-style-type: none"> 1. Select "Exit" from the list of setting items with \vee. 2. Press ENTER.

Attention

- While settings are being applied (registered) to the system, a "Setting" ("Registering") message is displayed. Do not turn off the monitor while the message is displayed. Otherwise, setting information may be lost.

Entering characters

1. Press ENTER.

The text field is highlighted in green.

2. Press the number buttons (0 to 9).

Press a button consecutively to change over to the character next in order. For the order of character entry, refer to the table shown below.

Button	Input characters								
0	0	-	_	:	.	/	(space)		
1	1								
2	a	b	c	A	B	C	2		
3	d	e	f	D	E	F	3		
4	g	h	i	G	H	I	4		
5	j	k	l	J	K	L	5		
6	m	n	o	M	N	O	6		
7	p	q	r	s	P	Q	R	S	7
8	t	u	v	T	U	V	8		
9	w	x	y	z	W	X	Y	Z	9

To enter a new character, press >.

To delete a character, press CLEAR.

3. Press ENTER.

Note

- Entering network addresses
Network address text fields are separated by [.] (a period mark).
 - When a three-digit number is entered, the cursor automatically moves to the next entry position.
 - When entering a two-digit or one-digit number, press > to move to the next entry position.
- When using a USB mouse
 - When you enter a period ".", the cursor moves to the next entry position.
 - To enter characters, click "Keyboard" on the character entry screen. Then click the keys on the displayed keyboard to enter characters.

Attention

- The remote control cannot be used to select the character entry screen keyboard.
-

2-3. Setting Network Cameras

● To automatically discover network cameras

Discover network cameras on the network automatically and register them to the system.

This procedure is for setting network cameras connected after performing “Easy Setup” upon initial startup of the monitor.

Attention

- Only the network cameras installed in the same subnet as the monitor are detected. If a network camera is installed in a different subnet, the camera must be registered manually (see “To manually register network cameras” (page 15)).
- When network cameras are not detected by automatic discovery, see “Chapter 4 Troubleshooting” (page 78).
- For information on “Easy Setup”, refer to the Setup Manual.

Procedure

1. Select “Auto Discovery”.
2. Select “Camera Discovery” and press ENTER.
3. Select the camera type using \wedge or \vee , then press ENTER.
Displays registered network cameras.
4. Select “Start” and press ENTER.

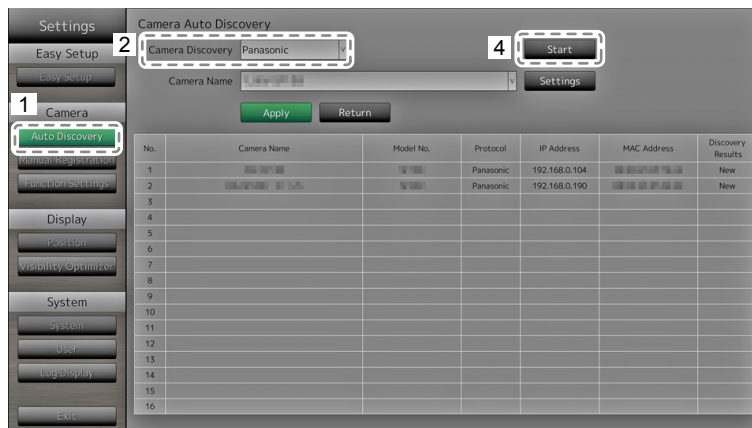

The camera user authentication screen is displayed.

5. Enter the “Username” and “Password” of the user who has administrator’s rights, specified in the network camera.

The following values are entered as the default settings. Change the settings if necessary. Please contact your system administrator for the username and password.

- Username: “admin”
- Password: “12345”

6. Select “OK” and press ENTER.

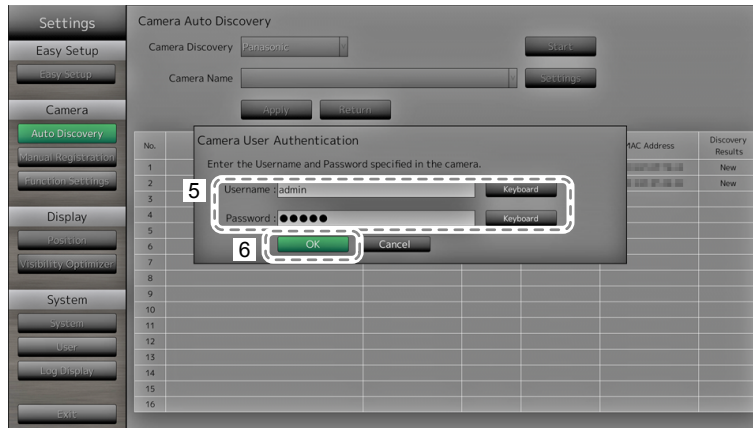

Automatic discovery is started and a “Searching” message is displayed. When the search is completed, the discovered network cameras are added to the list. A subsequent result is displayed in the detection results for camera discovery.

Discovery Results	Description
Blank	When there is no information update for the registered network cameras, or one is not connected
New	When there is an unregistered network camera, or information was updated for a registered network camera
Duplicate	When there is a network camera with a duplicate IP address

7. Select “Apply”.

The setting complete screen is displayed. Select “OK”.

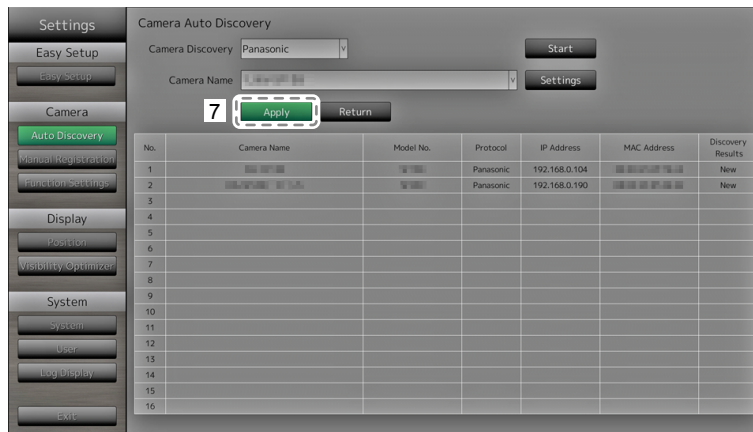

Note

Panasonic network camera

- The settings of the newly detected network camera can be changed. Select the network camera whose settings you want to change at “Camera Name” and then select “Settings”. Configure the items on the displayed setting screen. The items that can be set differ depending on the network camera.
- When registered automatically, stream and channel for accessing the network camera are automatically set to the following values. You can change the settings in “Manual Registration” (refer to [“To manually register network cameras” \(page 15\).](#)) Please contact your system administrator for your username and password to access the network camera.
 - Stream: “2”
 - Channel: “1”
 - RS485 PTZ Control: “Off”^{*1}
 - *1 Only set “RS485 PTZ Control” to “On” when connecting an external device to the network camera using a RS485 cable.

AXIS network camera

- When executing automatic detection with an incorrect user name or password, “-----” is displayed for the model name.
- When a detected IP address is a duplicate of a registered network camera, but the username and password are correct, ‘Model Name – MAC Address’ is displayed, and “-----” is displayed for the model name.

● To manually register network cameras

Register network cameras manually for cases described below.

- When a network camera is installed in a subnet differing from the subnet of the monitor
- When settings such as network settings of a registered network camera have been changed
- When registering a video encoder which supports multiple channels

Procedure

1. Select “Manual Registration”.

A list of network cameras currently registered is displayed.

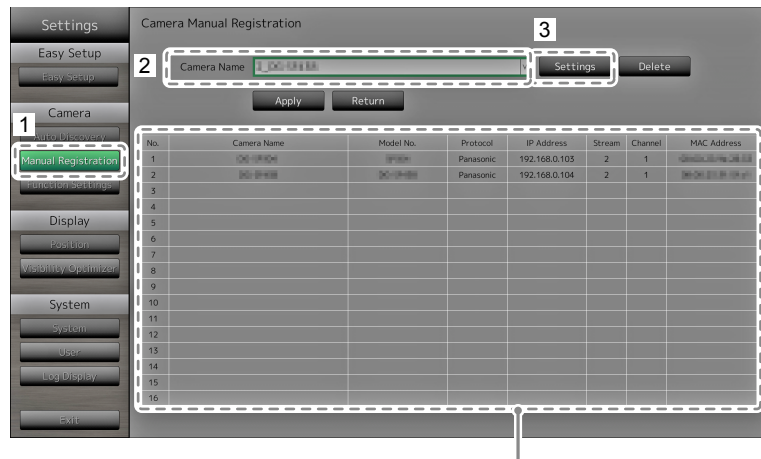

Registered cameras are displayed.

2. Select the network camera to configure at “Camera Name”.

When registering a network camera installed in a subnet differing from the subnet of the monitor, select an available number (with no network camera registered). For a network camera that is already registered, select the network camera of which to change settings.

3. Select “Settings”.

The network camera setting screen is displayed.

4. Configure the items.

For setting details, contact your system administrator.

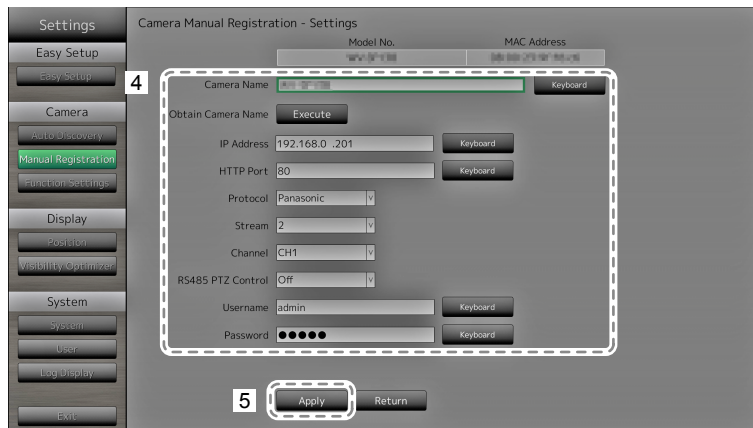

Item	Detail	Setting range
Camera Name	Enter the camera name. When selecting 'Execute' for 'Obtain Camera Name,' the camera name is automatically obtained from the network camera. <ul style="list-style-type: none"> • Panasonic network camera: Camera Name • AXIS network camera: Camera Name • Network camera compatible with the "ONVIF" protocol: Camera model number, manufacturer name, etc. 	Alphanumeric characters (up to 24 characters)
IP Address	Enter the network camera IP address.	0.0.0.0 to 255.255.255.255
HTTP Port	Enter the network camera HTTP port number.	1 to 65535
Protocol	Select the protocol for controlling the camera.	Panasonic / AXIS / ONVIF
Stream* ¹	Set the number of the stream for delivering camera images. Select a stream supported by the connected network camera.	CH1 to CH4
Channel* ¹	Select the channel of the analog encoder. Set to "1" if the network camera does not support the channel function.	CH1 to CH4
RS485 PTZ Control* ¹	Controls the brightness, automatic focus adjustment, pan, tilt and zoom for devices that are connected to the network camera via a RS485 cable.	On / Off
Username* ²	Enter the username to use when accessing network cameras.	Alphanumeric characters and symbols (up to 32 characters)
Password* ²	Enter the password to use when accessing network cameras.	Alphanumeric characters and symbols (up to 32 characters)

*¹ Supported only when compatible with the Panasonic protocol.

*² Enter the username with administrator rights and the password.

5. Select “Apply”.

The setting complete screen is displayed. Select “OK”.

Attention

- If you want to change the set values using the remote control, press the CLEAR button, then enter the values (for details see [“Entering characters” \(page 11\)](#)).
- Depending on the network camera type, the “Model No.” displayed on the setting screen may differ from when the camera is discovered automatically and when it is registered manually.
- Only set “RS485 PTZ Control” to “On” when connecting an external device to the network camera using a RS485 cable.

Note

- With manual registration, network settings of a camera cannot be changed. When changing the network settings of a camera, check the network camera’s manual.

● To set network camera functions

Set the network camera functions from the monitor.

Procedure

1. Select “Function Settings”.



2. Select the network camera to configure at “Camera Name”.

3. Select a function.

The setting screen for the selected function is displayed.

Attention

- The network camera set to “DirectUri” can be registered or configured only from the Web browser. It cannot be registered or configured from the monitor screen. For the registration and configuration of the network camera set to “DirectUri”, refer to [“Manual Registration of Cameras / Changing Camera Information” \(page 50\)](#).

Camera Information Display

Select to display or not display the camera information and time of the network camera settings on the camera images.

Attention

- It is not possible to configure the network camera when its “Protocol” is set to “ONVIF”, “AXIS”, or “DirectUri”.

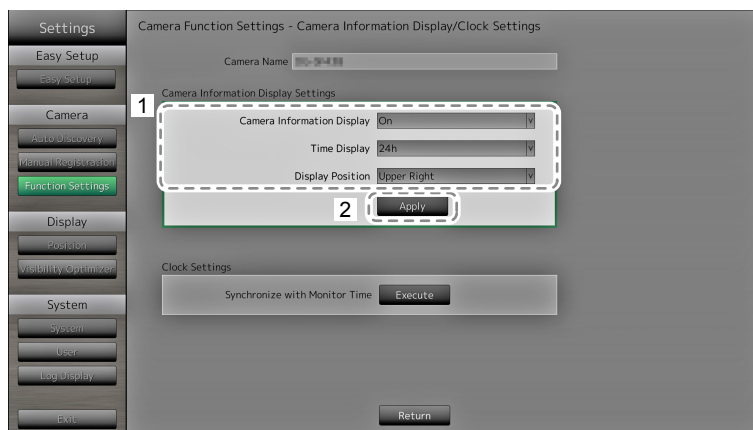

- Configure the items.

Item	Detail	Setting range
Camera Information Display	Set whether or not to display camera information.	On / Off
Time Display	Set whether or not to display the time.	12h / 24h / Off
Display Position	Set the display position of the camera information and time.	Upper Left / Upper Right / Lower Left / Lower Right

- Select “Apply”.

The setting complete screen is displayed. Select “OK”.

Clock Settings

- Synchronizes the time of the network camera with the time of the monitor.

Select “Execute” to synchronize the clock.

Video Settings

Set the Image Quality of transmitted images for the network camera.

Note

- This product supports H.264 and MJPEG (ONVIF only) video compression formats.

Attention

- When devices such as recorders are connected to a network camera, the display and recording of such devices may be affected.
- It is not possible to configure the network camera when its “Protocol” is set to “DirectUri”.

When using a Panasonic network camera

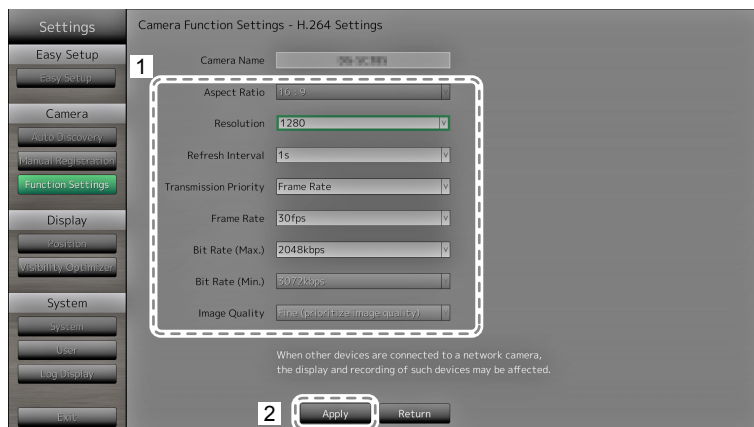

1. Configure the items.

Item	Detail	Setting range
Aspect Ratio	Set the H.264 aspect ratio.*1	Network camera imaging mode
Resolution	Set the H.264 resolution.	According to the network camera specification
Refresh Interval	Set the refresh interval*2 of H.264 images.	0.2s / 0.33s / 0.5s / 1s / 2s / 3s / 4s / 5s
Transmission Priority	Set the transmission mode of H.264 images.	Constant Bit Rate / Frame Rate / Best Effort
Frame Rate	(When the mode is set to "Frame Rate" at "Transmission Priority".) Set the frame rate (image update interval) of H.264 images.*3	1fps / 3fps / 5fps / 7.5fps / 10fps / 12fps / 15fps / 20fps / 30fps
Bit Rate (Max.)	Set the maximum H.264 image bit rate.	64kbps / 128kbps / 256kbps / 384kbps / 512kbps / 768kbps / 1024kbps / 1536kbps / 2048kbps / 3072kbps / 4096kbps / 8192kbps
Bit Rate (Min.)	(When the mode is set to "Best Effort" for "Transmission Priority".) Set the minimum H.264 image bit rate.	64kbps / 128kbps / 256kbps / 384kbps / 512kbps / 768kbps / 1024kbps / 1536kbps / 2048kbps / 3072kbps / 4096kbps / 8192kbps
Image Quality	(When the mode is set to "Constant Bit Rate" or "Best Effort" for "Transmission Priority".) Set the H.264 image quality.	Low (prioritize motion) / Normal / Fine (prioritize image quality)

*1 When "1920" is selected for "Resolution", the aspect ratio is fixed to 16:9. The aspect ratio cannot be set when the network camera "Stream" is set to a value other than "1".

*2 For H.264 images, the differential data between the full screen frame data and previous frame are sent periodically. "Refresh Interval" refers to the interval for sending these full screen frame data. Shortening this interval improves the stability of image quality but also increases the load on the network. "Refresh Interval" refers to the interval at which the full screen data is transmitted. Shortening this interval improves the image quality but also increases the load on the network.

*3 The shorter the interval, the shorter the update interval and the smoother the display, but also the larger the load on the network.

2. Select "Apply".

The setting complete screen is displayed. Select "OK".

Attention

- To display the multicast stream of Panasonic network cameras, configure multicast on the camera.
- When you change the "Aspect Ratio," the network camera imaging mode will change. Depending on the imaging mode, the image quality of other recording devices or display devices may be impacted. Check the impact of changes to the imaging mode before configuring the settings.

When using an AXIS network camera

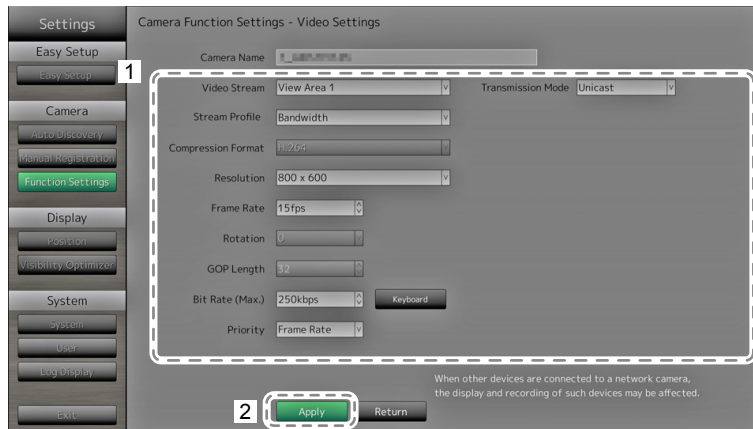

1. Configure the items.

Item	Detail	Setting range
Video Stream	Select the display mode for screens that display network camera images.	According to the camera specification
Stream Profile	Select the profile that the network camera has.	According to the camera specification
Compression Format	Select the compression format.	H.264 (Fixed)
Resolution	Set the resolution of H.264 images.	According to the camera specification
Frame Rate	Set the frame rate (image update interval) of H.264 images.	According to the camera specification (Maximum possible values 30fps)
Rotation* ¹	Show the rotational direction of the network camera image.	According to the camera specification
GOP Length	Set the GOP length for video.	I-frame Interval (only when H.264 is selected)
Bit Rate (Max.)	Set the maximum H.264 image bit rate.	According to the camera specification (Maximum possible values 8192 kbps)
Priority	Set the preference for video compression.	None / Frame Rate / Quality
Transmission Mode	Select the transmission method for AXIS camera images.	Unicast / Multicast
Multicast Address* ²	Show the multicast address for multicast transmission of H.264 images.	224.0.0.0 to 239.255.255.255
Multicast Port* ²	Show the multicast port number for multicast transmission of H.264 images.	1824 to 65534 even numbers only
Multicast TTL* ²	Show the network TTL value for multicast transmission of H.264 images.	According to the camera specification

*1 For details on rotation settings, refer to the network camera user's manual.

*2 Displays when "Transmission Mode," or "Multicast" is selected.

2. Select "Apply".

The setting complete screen is displayed. Select "OK".

Attention

- To display the multicast stream of AXIS network cameras, configure multicast on the camera.

ONVIF Profile S-compatible network cameras

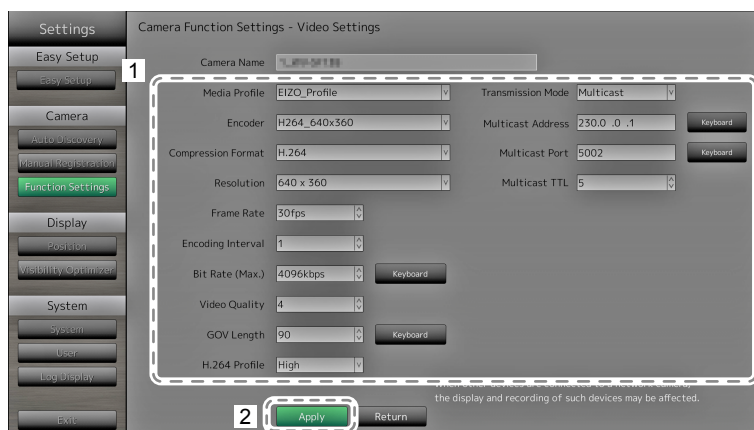

1. Configure the items.

Item	Detail	Setting range
Media Profile	Select the ONVIF image profile.	EIZO_Profile / camera profile
Encoder	Select the encoder settings of ONVIF images.	According to the camera specification
Compression Format	Select compression format of ONVIF images.	H.264 / MJPEG
Resolution	Set the resolution of ONVIF images.	According to the camera specification
Frame Rate	Set the frame rate (image update interval) of ONVIF images.	1 to 30 fps
Encoding Interval	Set the encoder interval of ONVIF images.	According to the camera specification
Bit Rate (Max.)	Set the maximum ONVIF image bit rate.	0 to 8192 kbps
Video Quality	Set the ONVIF image quality. The higher the value, the higher the image quality.	According to the camera specification
GOV Length* ¹	Set the I-frame interval of ONVIF images.	According to the camera specification
H.264 Profile* ¹	Select a H.264 standard profile.	Baseline / Main / Extended / High
Transmission Mode	Select the transmission format of ONVIF images.	Unicast / Multicast
Multicast Address* ²	Set the multicast address for multicast transmission of ONVIF images.	224.0.0.0 to 239.255.255.255
Multicast Port* ²	Set the multicast port number for multicast transmission of ONVIF images.	1824 to 65534 even numbers only
Multicast TTL* ²	Set the network TTL value for multicast transmission of ONVIF images.	According to the camera specification

*¹ Displays when "H.264" is selected in "Compression Format".

*² Displays when "Multicast" is selected in "Transmission Mode".

2. Select "Apply".

The setting complete screen is displayed. Select "OK".

Attention

- Depending on the network camera type, some set values may not be reflected. Check the specifications of the camera.
- When changes are made to the image quality settings such as resolution, this may impact on the image quality of other recording devices and display devices using the same "Encoder". Check the impact of changes to the image quality settings before configuring the settings.

Preset

Preset the shooting position and adjustment status of the network camera.

Displays images of the selected network camera.

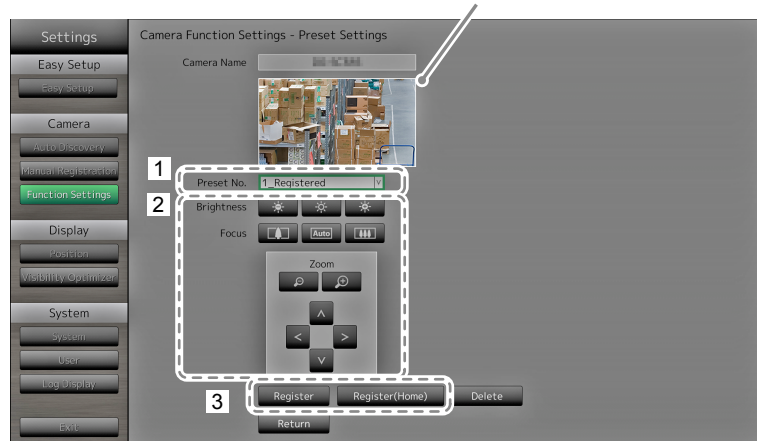

1. Select the number (1 to 256) to set for "Preset No".
2. Configure the items.

Item	Detail	Setting range
Brightness	Adjust the network camera brightness.	According to the camera specification
Focus	Adjust the network camera focus.	According to the camera specification
Zoom	Adjust the network camera display magnification.	According to the camera specification
Position	Adjust the network camera shooting position (pan / tilt).	According to the camera specification

3. Select "Register (Home)" for registering the selected number as the home position. For all other registrations, select "Register".

The registration completion screen is displayed. Select "OK".

Attention

- It is not possible to configure the network camera when its "Protocol" is set to "AXIS" or "DirectUri". Set the preset settings on the camera side.
- Depending on the type of the network camera you are using, some functions may not be available.
- Depending on the network camera type, it may not be possible to register the brightness and focus settings.

Note

- After the setting is registered, the number displayed at "Preset No." changes from "Not Registered" to "Home" or "Registered".
- To clear a setting, select the number to clear at "Preset No." and then select "Delete". The data set for the number is deleted and the number status returns to the unregistered state.

Other

Attention

- It is not possible to configure the network camera when its “Protocol” is set to “ONVIF”, “AXIS”, or “DirectUri”.

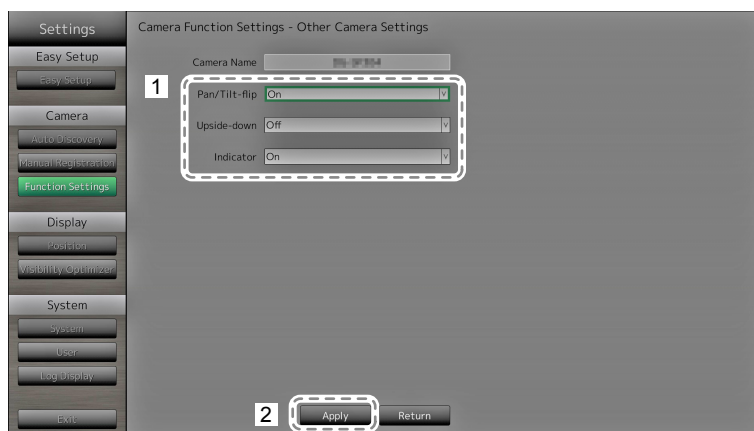

1. Configure the items.

Item	Detail	Setting range
Pan / Tilt-flip	Turn on / off the pan / tilt-flip function*1.	On / Off
Upside-down*2	Turn on / off the network camera upside down function.	On / Off
Indicator	Turn on / off the network camera Indicator.	On / Off

*1 The pan / tilt-flip function reverses the pan / tilt direction automatically at high-speed when the network camera reaches the movement endpoint. This function allows the user to make pan / tilt operations without paying attention to movement endpoints.

*2 Check the network camera installation specifications before using the upside down function. Depending on the network camera type, it may not be possible to install the camera upside down even when the camera supports the upside down function.

2. Select “Apply”.

The setting complete screen is displayed. Select “OK”.

2-4. Setting Display Positions of Camera Images

Set the display position for images from the network camera.

Procedure

1. Select "Position".



2. Configure the items.

Item	Detail	Setting range
Position	Select a position to display a camera image. Set the network camera to the number of the desired position for display.	-
Camera Name Display	Select to display or not display the camera name and time set on the monitor. (The camera name is displayed on the upper left of the image.)	On / Off
Sequence Interval	Set the interval for changing over the screen during sequential display.	5s to 60s
Aspect Ratio Mode	Set which aspect ratio to apply when the aspect ratio of the video delivered from the network camera and the aspect ratio of the monitor image display area differ. If "Aspect" is selected when "Custom Screen" is selected for the "Image Layout" (page 58), you can select either "Full" or "Aspect" for each camera image.	Full / Aspect

3. Select "Apply".

The setting complete screen is displayed. Select "OK".

Attention

- All registered network cameras must be configured. A network camera can only be set for one display position. When there are incorrect settings, "Apply" cannot be selected.
- When displaying the image layout in three screens
 - Suitable for portrait input images. To display portrait images, network cameras require separate settings. For details on the settings, refer to the network camera User's Manual.

Note

- If it takes a while for images to be displayed during sequential display, set a higher value for "Sequence Interval".

2-5. Setting Visibility Optimizer Function

Set Visibility Optimizer function for images from each camera.

Procedure

1. Select "Visibility Optimizer".

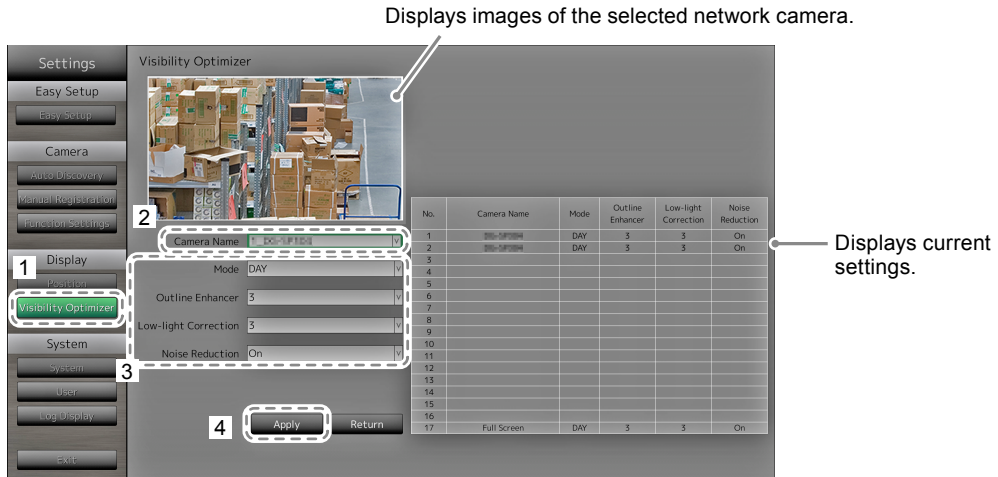

2. Select the network camera to configure at "Camera Name".

Attention

- For 1 Screen or 4 Screens layouts the settings of each network camera are applied. If the image layout is displayed in 3 Screens, 8 Screens, 9 Screens, or 16 Screens and if "Custom Screen" is selected, the "17_Full Screen" settings are applied to all screens and the settings of each network camera are not applied.

3. Configure the items.

Item	Detail	Setting range
Mode	Select the display mode to apply to the images of the selected network camera. Set to "DAY" to apply a mode suitable for general images. Set to "NIGHT" to apply a mode suitable for monochrome images such as images taken at night.	DAY / NIGHT / Off
Outline Enhancer	Adjusts the perceived resolution of the images so that the blurs are reduced and images are displayed vividly and clearly.	1 to 5 / Off
Low-light Correction	Makes dark areas of images visible by analyzing the image and correcting the brightness for each pixel. It is effective for images with dark area that are less visible and for bright environments.	1 to 5 / Off
Noise Reduction	Reduces the amount of block noise that occurs due to video compression.	On / Off

4. Select "Apply".

The setting complete screen is displayed. Select "OK".

2-6. Configuring System Settings

Set the date, time and network information for this product.

Procedure

1. Select "System".

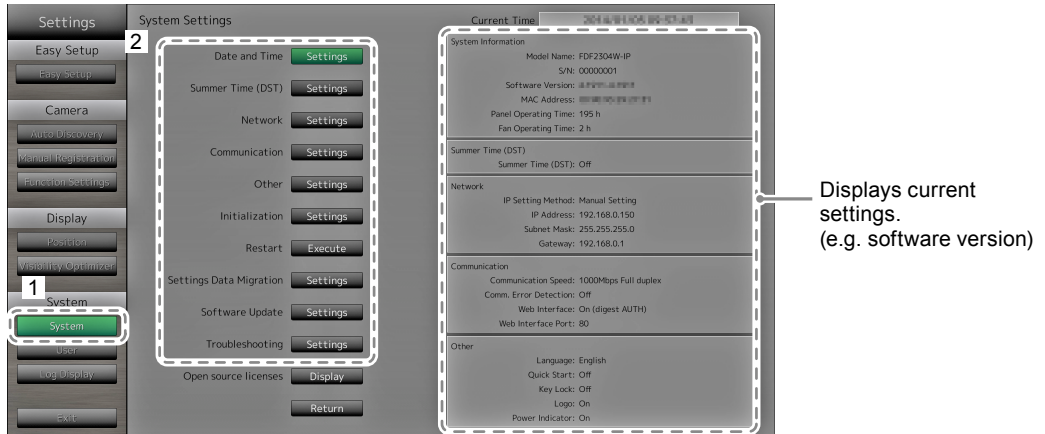

2. Select a setting.
The setting screen for the selected setting is displayed.

Date and Time Settings

Set the current date and time.

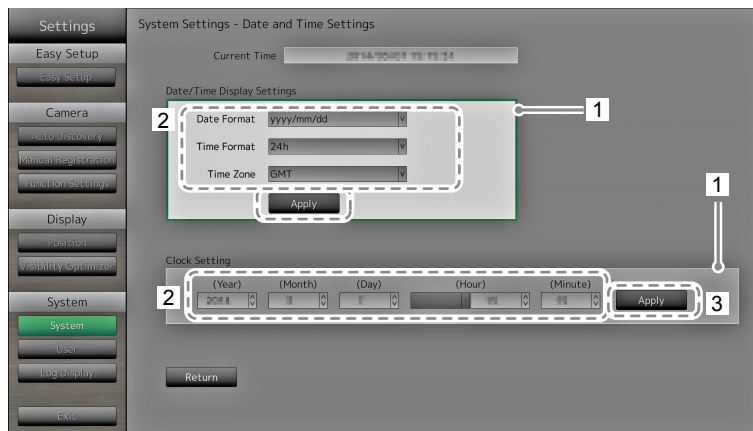

1. Select "Date / Time Display Setting" or "Clock Setting".
2. Configure the items.

Item	Detail	Setting range	
Date / Time Display Settings	Set the date display format, time display format, and time zone (time difference between GMT*1).	Date Format	yyyy/mm/dd, Mmm/dd/yyyy, dd/Mmm/yyyy, mm/dd/yyyy, dd/mm/yyyy
		Time Format	24h / 12h
		Time Zone	GMT-12:00 to GMT+14:00
Clock Setting	Set the current time.	2010/1/1 0:00 to 2035/12/31 23:59	

*1 Greenwich Mean Time

3. Select “Apply”.

The setting complete screen is displayed. Select “OK”.

Attention

- Time zones differ according to the sales region. This needs to be set.
- If the time zone has been changed, daylight saving time will be turned off. (For details, refer to “[Summer Time \(DST\)](#)” (page 27) in the next section).

Note

- If the main power switch is turned off or the power cord is unplugged for one week or longer, the monitor’s time and date will no longer be displayed accurately. In such a case, set the date and time again.

Summer Time (DST)

Apply or cancel the summer time setting (DST).

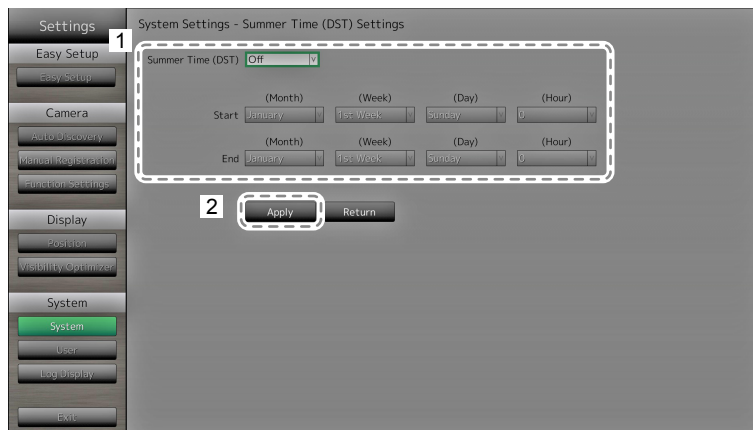

1. Configure the items.

Item	Detail	Setting range
Summer Time (DST)	Applies or cancels the summer time setting. Set to “On” to apply to summer time immediately. Set to “Off” to not apply to summer time. Set to “Auto” to apply to summer time automatically during the period designated by the start / end dates and times.	On / Off / Auto

2. Select “Apply”.

The setting complete screen is displayed. Select “OK”.

Network

Set network information.

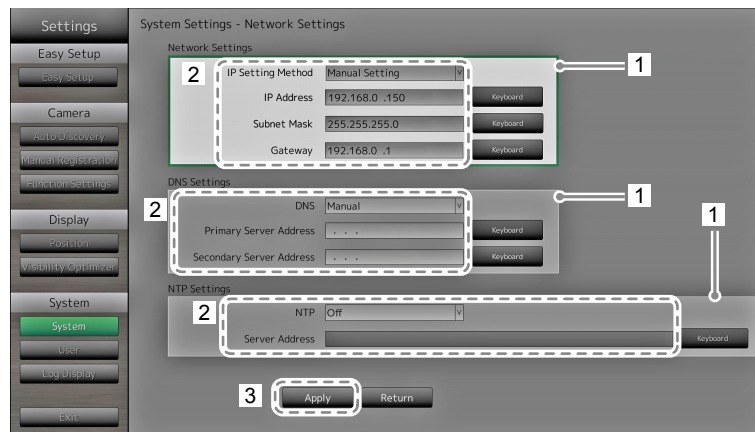

1. Select “Network Settings”, “DNS Settings” or “NTP Settings”.
2. Configure the items.

Item	Detail	Setting range	
Network Settings	Select the IP address setting method.	IP Setting Method	DHCP / Manual Setting
	If “Manual Setting” is selected, set the IP address, subnet mask and gateway.	IP Address, Subnet Mask, Gateway ^{*1}	0.0.0.0 to 255.255.255.255
DNS Settings	Set the DNS. (When “IP Address” of “Network Settings” is set to “Manual Setting”.)	DNS	Auto / Manual
	If you selected “Manual”, set the primary server address and the secondary server address.	Primary Server Address, Secondary Server Address	0.0.0.0 to 255.255.255.255
NTP Settings	Set whether or not to use an NTP server.	NTP	On / Off
	If you selected “On”, set the NTP server address.	Server Address	Alphanumeric characters and symbols

*1 If your network environment does not include a gateway, you do not need to set the “Gateway” address. Use the default setting as is, or set as “0.0.0.0”.

3. Select “Apply”.
The setting complete screen is displayed. Select “OK”.

Communication Settings

The communication settings are used to configure the web interface function, detection of communication errors, and so on.

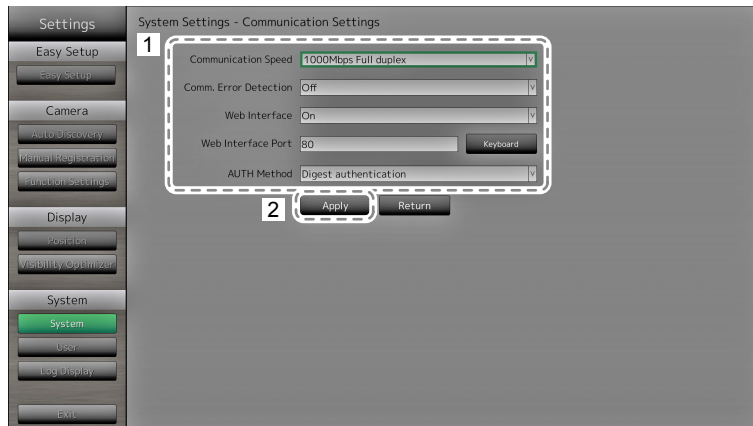

1. Configure the items.

Item	Detail	Setting range
Communication speed	Sets the communication speed between the monitor and network hub.	100Mbps Half duplex / 100Mbps Full duplex / 1000Mbps Full duplex
Communication Error Detection	You can set the following as the message to be displayed when receipt of image data stops. Comm. Error Detection On: Within several seconds after receipt of image data stops, an alert message in a red box will appear on the live image screen. When communication resumes, the alert is cleared and the image is displayed again. Comm. Error Detection Off: When approx. 20 seconds have elapsed after receipt of image data stops, a communication error message will appear.	On / Off
Web Interface	You can operate and configure the monitor from your web browser over the network.	On / Off
Web Interface Port	Sets the port of the web interface.	1 to 65535
AUTH Method	Sets the authentication method for the web interface.	Digest authentication / BASIC authentication

2. Select "Apply".

The setting complete screen is displayed. Select "OK".

Other

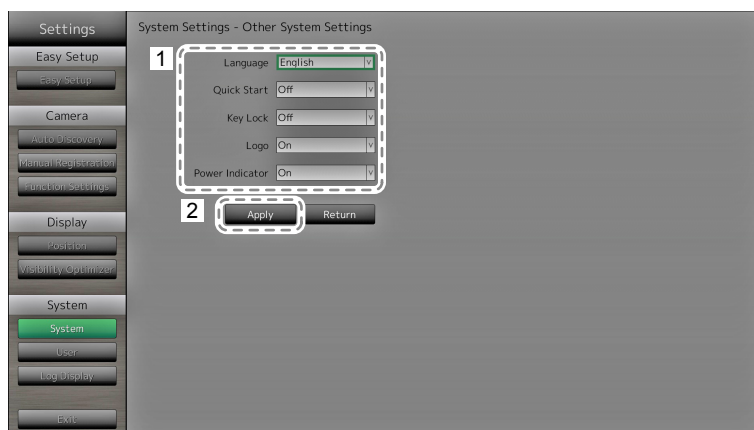

1. Configure the items.

Item	Detail	Setting range
Language	Set the display language of the menu and the setting screen.	日本語 / English / Deutsch / Polski* ¹
Quick Start	Set the status of the system when turned off. When set to “On”, part of the system remains running. When set to “Off”, the system is shut down completely. By setting to “On”, the startup time for this product can be reduced (approx. 10 seconds). However, do not turn off the main power of the monitor when Quick Start is set to “On” because part of the system remains running.	On / Off
Key Lock	Locks operations by the buttons on the front of the monitor.	On / Off
Logo	Set whether to display / hide the EIZO logo when the power is turned on* ² .	On / Off
Power Indicator	Set whether to turn of or off the power indicator (blue) while the monitor is on.	On / Off

*¹ If “Polski” is selected for HDMI signal input, the display language is set to English.

*² The rotating bar indicating that the system is starting up cannot be hidden.

2. Select “Apply”.

The setting complete screen is displayed. Select “OK”.

Initialization

Initialize the system.

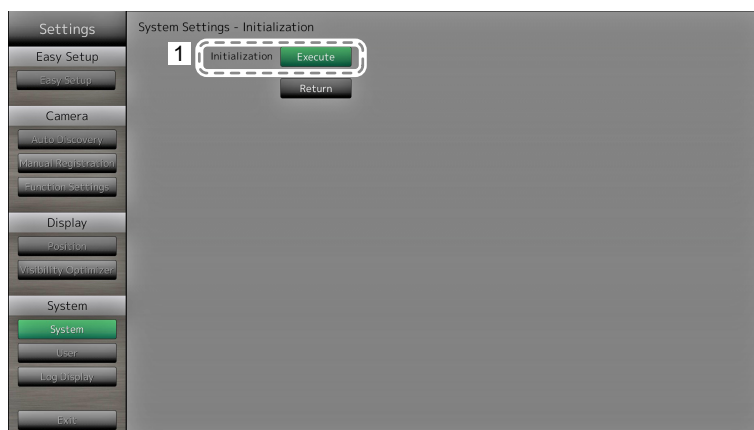

1. Select “Execute” for “Initialization”.

All settings are returned to default except for system logs, operation logs, the current time, time zone and summer time settings.

Restart

Restart the system.

1. Select “Execute” at “Restart”.

Settings Data Migration

You can save the settings data to a USB storage device and load the data.

Load Settings Data

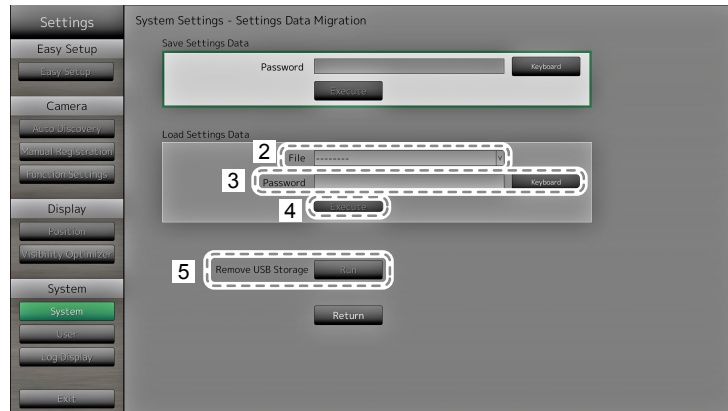

1. Connect a USB storage device to the USB downstream port of the monitor.
2. Select the settings data file.
3. Enter the password.
The password is blank by default. Set the password as necessary.
4. Select “Execute”. The settings data are loaded.
5. Select “Run” for “Remove USB Storage”.
When the Removing Complete screen is displayed, select “OK”.
6. Remove the USB storage device.

Attention

- The settings data include the IP address of the monitor. Change the IP address of the monitor if loading settings data from another monitor.
-

Save Settings Data

1. Connect a USB storage device to the USB downstream port of the monitor.

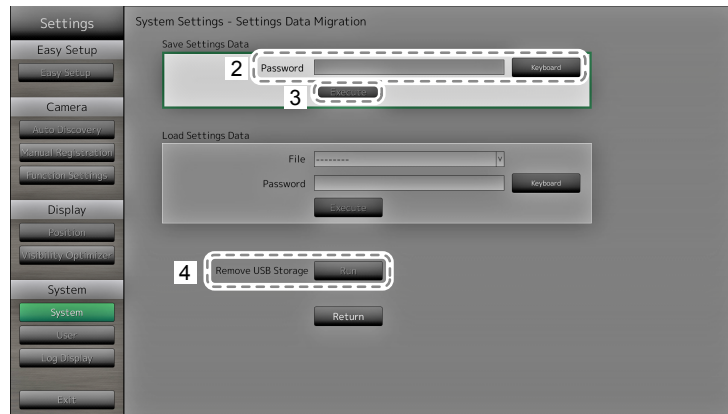

2. Enter the password.
The password is blank by default. Set the password as necessary.
3. Select “Execute”. The settings data are saved.
4. Select “Run” for “Remove USB Storage”.
When the Removing Complete screen is displayed, select “OK”.
5. Remove the USB storage device.

Attention

- Some of the settings cannot be saved.
- If you forget the password that you specified when saving the data, you will no longer be able to load the settings.

Note

- Saved file name: Backupyyyyymmdd.duraconf (yyyyymmdd is the save date)
-

Software Update

You can select update files from the File Selection screen, and can both upgrade or downgrade software.

1. Download the update file from the EIZO website (<http://www.eizoglobal.com>), and save it to a USB storage device.
2. Connect a USB storage device to the USB downstream port of the monitor.
The File Selection screen is displayed.

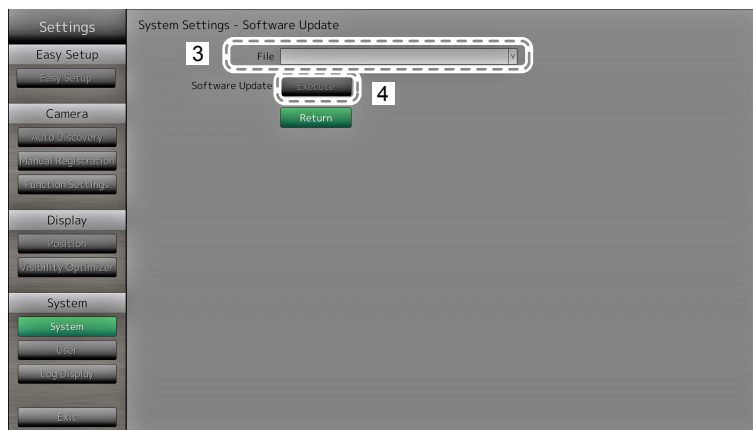
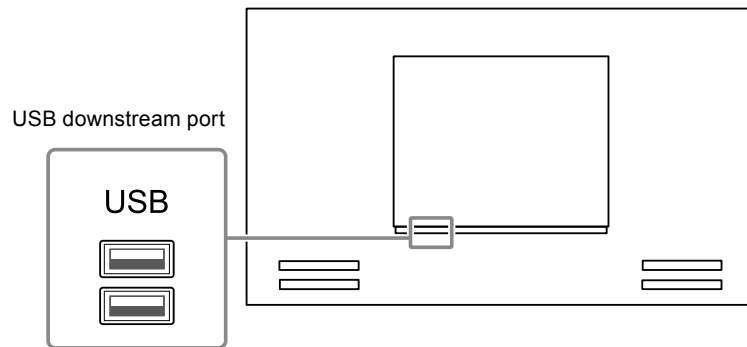

3. Select the update file.
4. Select "Execute".
5. The message saying "You must restart the system to update the software. Remove the USB storage and restart." appears. Remove the USB storage device.
6. Select "Restart" to restart the system.
The software is updated.

Attention

- Do not turn off the power while the software is being updated.
- You cannot operate the remote control and SIGNAL and POWER buttons on the front of the monitor while the software is being updated.
- The following USB storage devices can be used with this product (This does not guarantee operation of the USB storage devices given below).
 - USB 2.0 standard flash drives
 - Supported format: FAT32
- Do not connect multiple USB storage devices simultaneously.

Note

- When you restart your system, a message indicating the success or failure of the software update will appear. The message will clear automatically after 60 seconds if "OK" is not clicked. However, this message will not appear if you do the update through your web browser.
-

Troubleshooting

Use this function when this product does not operate normally, such as when a connection cannot be established with a network camera or a communication error occurs. The network status can be checked using communication commands and past error contents can be checked by displaying the system log. In addition, system log data can be saved to a USB storage device.

Checking network connection status



1. Select “Connection Confirmation”.
2. Select the network camera to check the network connection of for “Camera Name”.
3. Select “Run” for “ping” or “tracert”.

Results are displayed in the area on the right side of the screen.

Displaying the system log

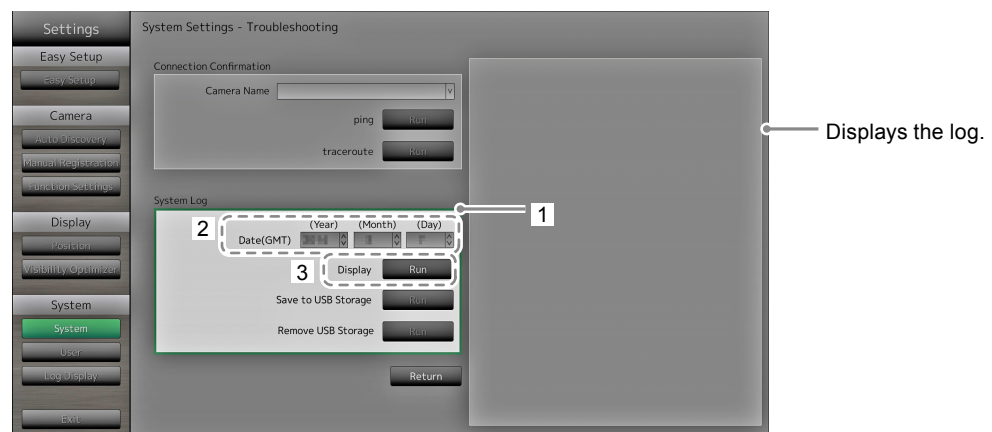

1. Select “System Log”.
2. Select the date (year / month / day) to display the log data of.
3. Select “Run” for “Display”.

The log data is displayed in the area on the right side of the screen.

Saving system log data

1. Connect a USB storage device to the USB downstream port on the back of the monitor.

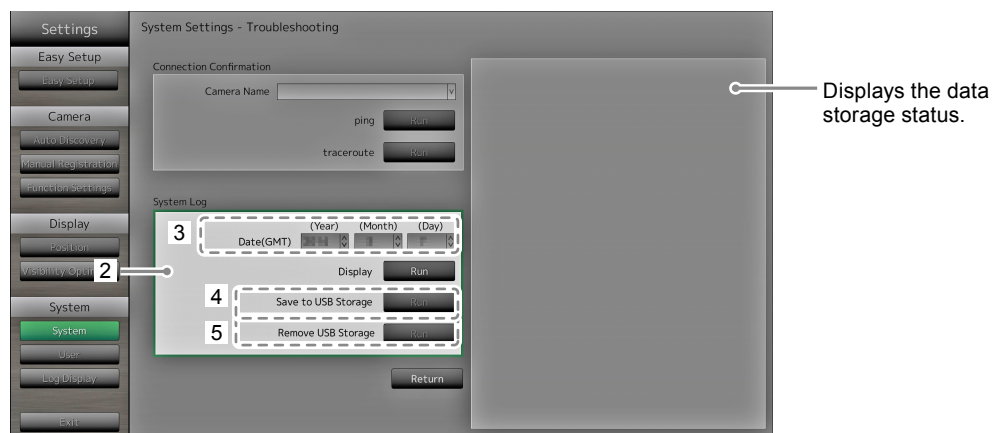
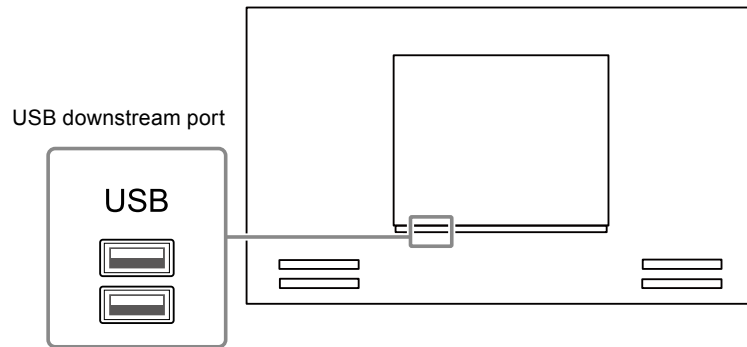

2. Select "System Log".
3. Select the date (year / month / day) of the log data to display.
4. Select "Run" for "Save to USB Storage".
Data saving starts and a "Saving" message is displayed in the display area on the right side of the screen.
When the saving complete screen is displayed, select "OK".
5. Select "Run" for "Remove USB Storage".
When the removing complete screen is displayed, select "OK".
6. Remove the USB storage device.

Attention

- The following USB storage devices can be used with this product (This does not guarantee operation of the USB storage devices given below).
 - USB 2.0 standard flash drives
 - Supported format: FAT32
- Do not connect multiple USB storage devices simultaneously.

2-7. Setting User Information

Register, change or delete information (username, user level and password) on users that access this product, and configure Auto Login settings.

Attention

- User information can be registered for up to 10 users. User information for a new user cannot be registered when there are already 10 users registered.
- Duplicate usernames cannot be registered.
- At least one user with a user level of "ADMIN" must be registered.
- You can use alphanumeric characters for the username, however, the following character is not allowed: " : ".

Note

- There are three user levels: "LIVE", "CAMERA CONTROL" and "ADMIN".
The operable range of this product differs by each level.

(√: Operable, -: Inoperable)

Operation Level	Menu display	Layout change over	Page change over	Visibility Optimizer function on / off	Login operation	Camera control	System settings
LIVE	√	√	√	√	√	-	-
CAMERA CONTROL	√	√	√	√	√	√	-
ADMIN	√	√	√	√	√	√	√

- The following user information is set by default:
 - Username: "admin"
 - Password: "admin"
 - User Level: "ADMIN"
- User information settings or Auto Login settings can be returned to default settings according to the following procedure. Use this feature, for example, when you have forgotten the registered user information.
 1. Press POWER on the remote control to turn off the monitor.
 2. Press the buttons on the remote control in the following order (press the next button within five seconds).
 < → < → > → > → ^ → ^ → POWER
 When the reset confirmation screen is displayed, select "Execute".
 User information is cleared and the settings are returned to the default settings.

● To register new user information

Procedure

1. Select “User”.
2. Select “Settings” on the “User Info. Settings” screen.

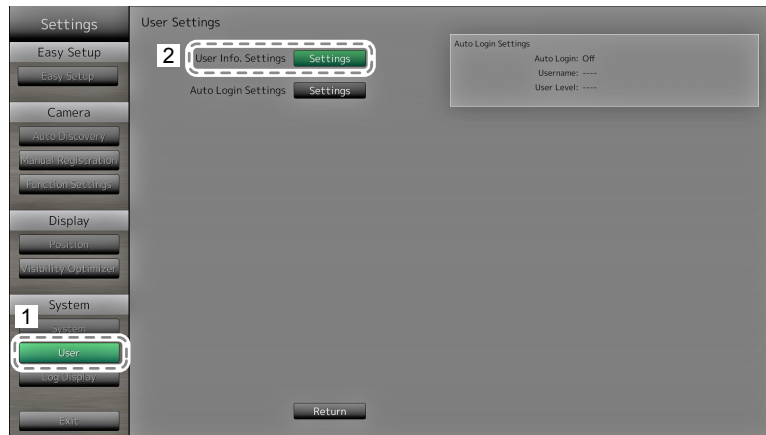

3. Select “New User Registration”.
4. Set user information.
5. Select “Register”.

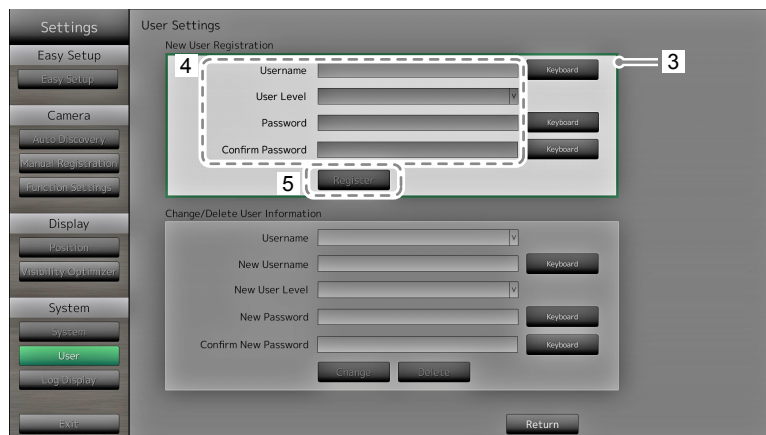

The registration completion screen is displayed. Select “OK”.

● To change user information

Procedure

1. Select “User”.
2. Select “Settings” on the “User Info. Settings” screen.

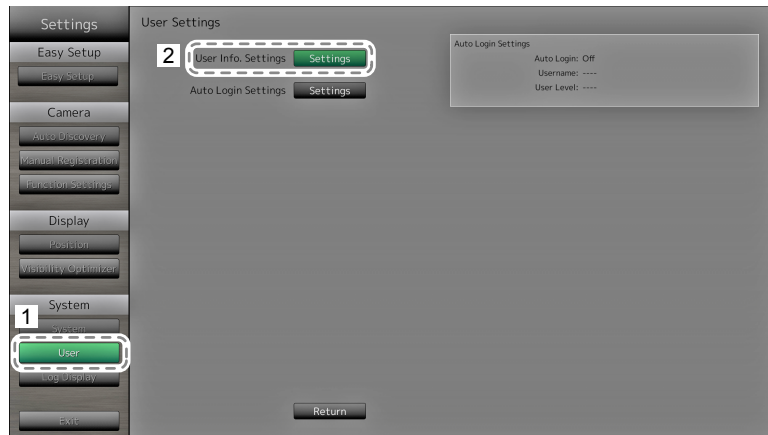

3. Select “Change / Delete User Information”.
4. Set user information.
5. Select “Change”.



The registration completion screen is displayed. Select “OK”.

● To delete user information

Procedure

1. Select “User”.
2. Select “Settings” on the “User Info. Settings” screen.

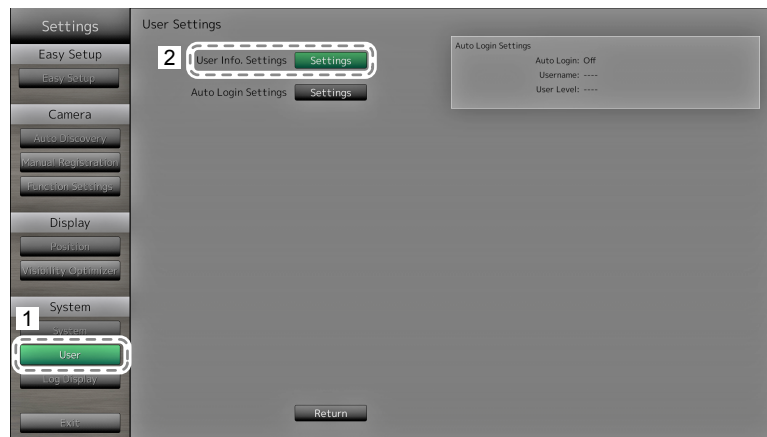

3. Select “Change / Delete User Information”.
4. Select the user to delete at “Username”.
5. Select “Delete”.

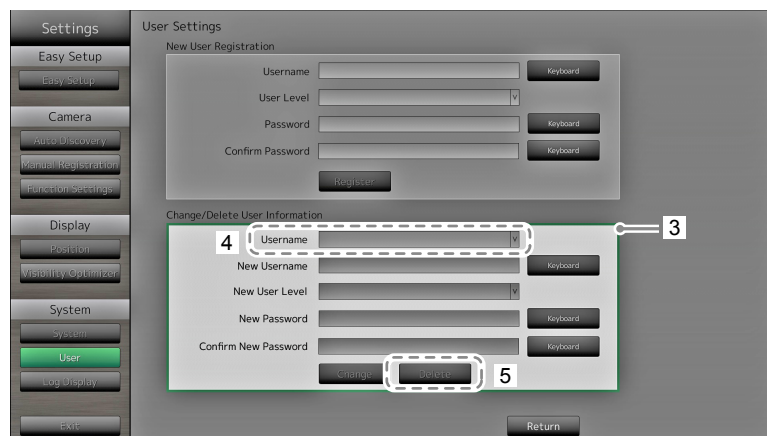

The deletion completion screen is displayed. Select “OK”.

● Configuring Auto Login Settings

Attention

- Once the Auto Login settings are configured, unauthorized operation becomes easy for a malicious third party. Restrict the configuration to the application in an environment where sufficient security is ensured.

Procedure

1. Select “User”.
2. Select “Settings” on the “Auto Login Settings” screen.

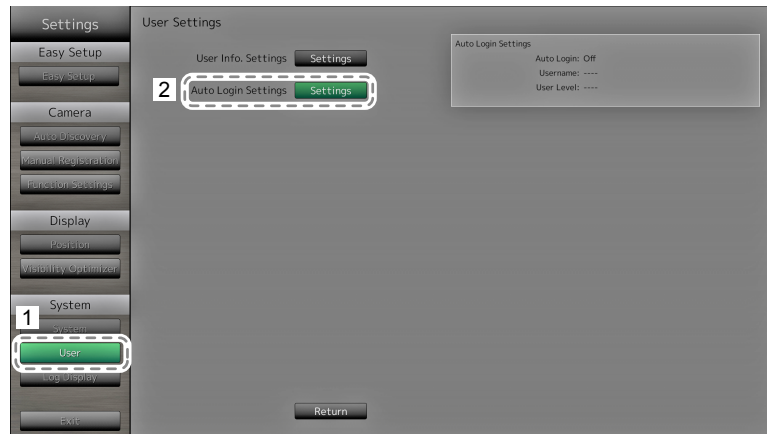

3. Configure the items.

Item	Detail	Setting range
Auto Login	Apply / release the Auto Login. Set to “On”, and you can log in to the system without the username and password.	On / Off
Username	Specify users to whom the Auto Login is to be applied.	Registered username
UserLevel	The user level is displayed for a user set under the “Username”.	ADMIN / CAMERA CONTROL / LIVE

4. Select “Apply”.
The setting complete screen is displayed. Select “OK”.

2-8. Displaying Operation Logs

Operations of this product are recorded on logs. Past operation results can be checked by displaying the log. Also, log data can be saved to a USB storage device.

Note

- The following data are recorded on the log:
 - Login information: The names of users who logged in to the system
 - Camera operation results: Name of operated camera, operation details, operation results
 - Date, time and details of changes confirmed by selecting “Apply” on setting screens
- Logs older than two months are automatically deleted at 04:00:00 AM on the first day of every month.

● To display log data

Procedure

1. Select “Log Display”.

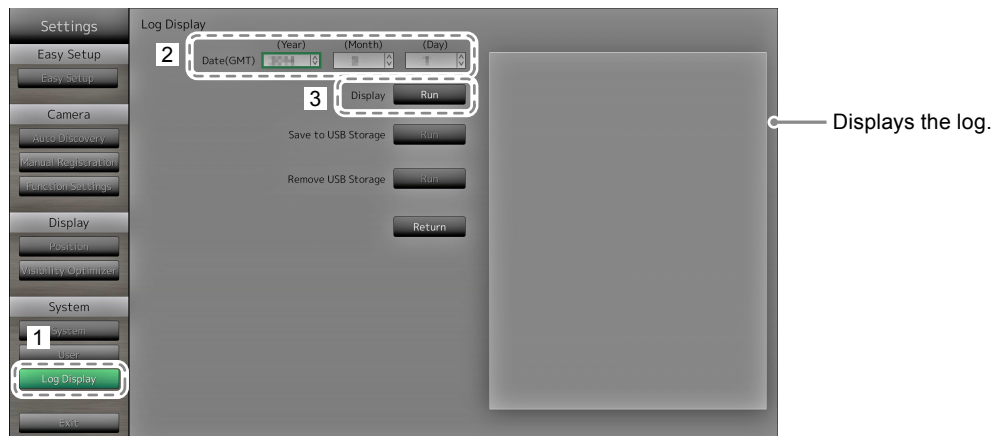

2. Select the date (year / month / day) to display the log data of.
3. Select “Run” for “Display”.
The log data is displayed in the area on the right side of the screen.

● To save log data

Procedure

1. Connect a USB storage device to the USB downstream port on the back of the monitor.

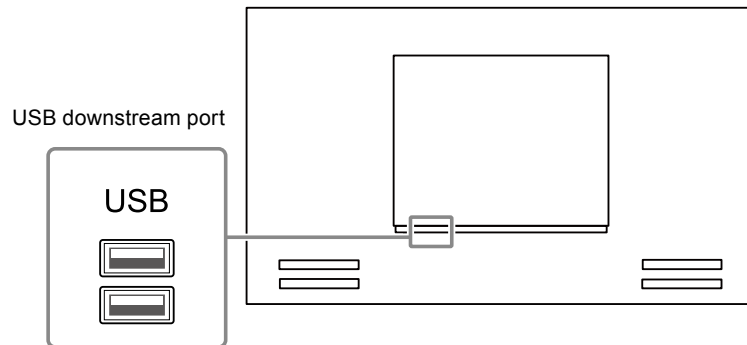

2. Select "Log Display".



3. Select the date (year / month / day) of the data to save.
4. Select "Run" for "Save to USB Storage".
Data saving starts and a "Saving" message is displayed in the display area on the right side of the screen.
When the saving complete screen is displayed, select "OK".
5. Select "Run" for "Remove USB Storage".
When the removing complete screen is displayed, select "OK".
6. Remove the USB storage device.

Attention

- The following USB storage devices can be used with this product (This does not guarantee operation of the USB storage devices given below).
 - USB 2.0 standard flash drives
 - Supported format: FAT32
- Do not connect multiple USB storage devices simultaneously.

Chapter 3 Configuring from a Web Browser

This product allows you to configure and operate network cameras from your web browser. Basic Information, Monitor Settings, and the Live Image Screen Settings are located on the Web control screen.

Note

- To configure from the monitor screen, see ["Chapter 2 Configuring from the monitor screen" \(page 9\)](#).

Attention

- It is recommended you use Internet Explorer 11 as your web browser.
- If you configure settings from a web browser, you will need to start up the monitor.
- You cannot display the web interface in your web browser when the monitor web interface is disabled in the settings (For details, see ["Communication Settings" \(page 63\)](#)).

3-1. Before Configuration

To configure settings from a web browser, you need to log in from the web browser you are using. Login is allowed only when the level of the user accessing the product is ADMIN.

Procedure

1. Press  on the front of the monitor or POWER on the remote control. The power indicator lights up blue and the live image screen is displayed. (For information on the live image screen, refer to the Instruction Manual.)
2. Display the web browser on your PC.
3. Enter the following address to access.

Address: <http://Address of the monitors/ui>^{*1}

*1 The default address for access is <http://192.168.0.150/ui>.

The login screen is displayed.



4. Enter a username and a password.
5. Select "OK".
Displays the Web Control Screen.

Note

- The following user information is set by default:
 - Username: "admin"
 - Password: "admin"
 - User Level: "ADMIN"
- For information on user settings, see ["2-7. Setting User Information" \(page 36\)](#).
- It is recommended that you log out after completing the setup, so as to prevent a third party from operating the network camera or altering the settings. Exit the web browser.

3-2. Web Control Screen

Basic Information, Monitor Settings, and the Live Image Screen Settings are located on the Web control screen.

Basic Information display lists of the various settings acquired from the monitor. The Monitor Settings are used for various settings such as network camera registration and monitor system settings. Live Image Screen Settings are used for displaying live image screen layout changes and the like.

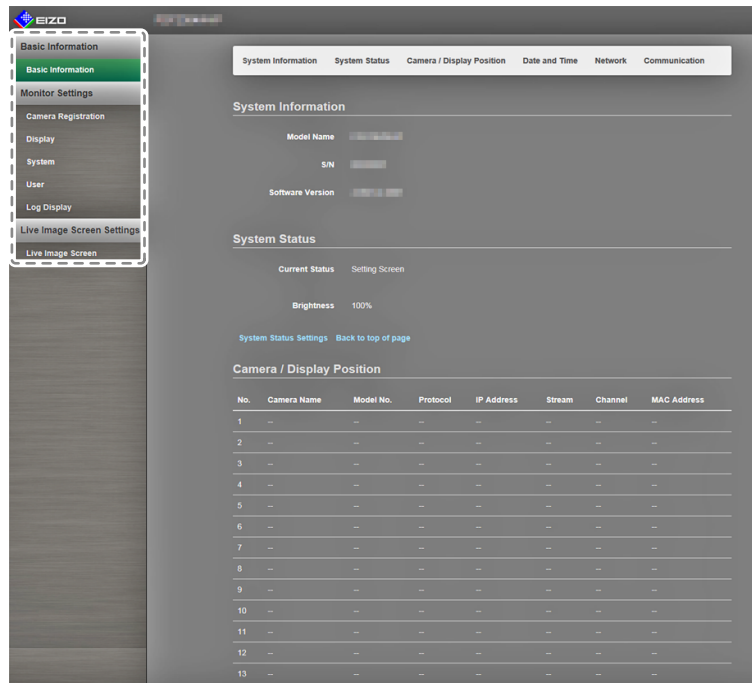

● Basic Operations

To select a setting item

- Click a setting item.
When you select a setting item, it will be displayed in green. In the case of a list box, when you select a list item, it will be displayed in green.

To apply a setting item

- Click “Apply” or “Register”.
A “Setting Complete” or “Setting Failed” message is displayed. Click “OK” as required.

To exit the web browser

- Click  in the web browser. This exits the browser.

Note

- If auto discovery is in progress on the monitor, or the setting dialog box is displayed in the browser, operations in the web browser will not be accepted. The busy message appears. Click “OK” to configure the settings again.

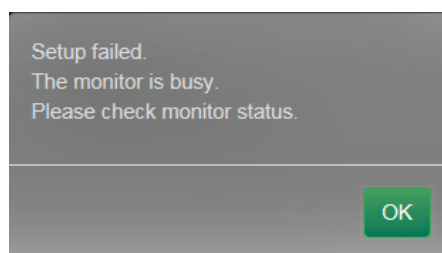

3-3. Basic Information

Display lists of the various settings acquired from the monitor.

To make various settings, click to item tab at the top of the screen. This moves you to the setting items page.

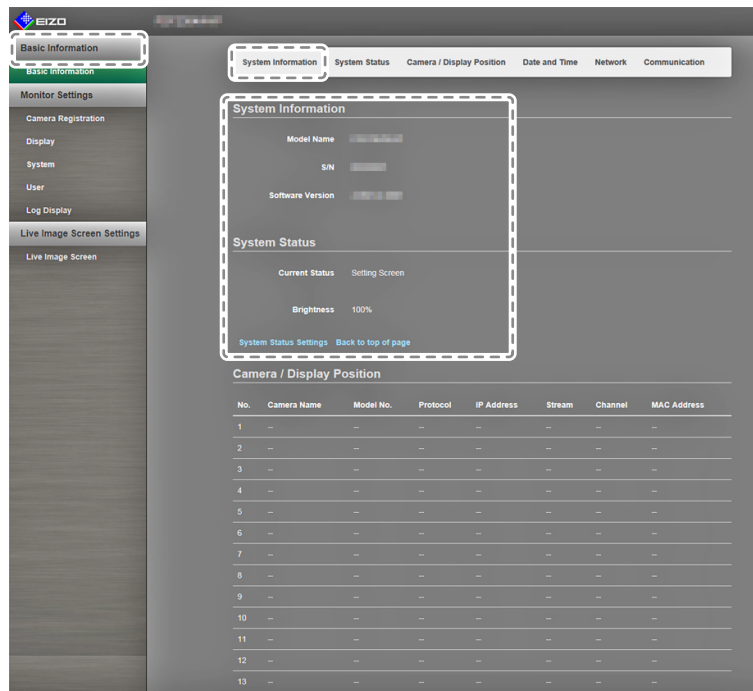

● System Information

Displays the current status of the monitor system.

- Model Name
- S / N
- Software Version

● System Status

Shows the monitor screen display status and brightness.

For this setting, click the link to “System Status Settings” or click “System Status” on the upper part of the screen. This moves you to the setting items page.

● Camera and Display Position / Date and Time Settings / Network Settings / Communication Settings

Displays the current settings status of the monitor.

To configure settings, click the link for the item name under an item, or click on the setting items tab at the top of the screen. This moves you to the setting items page.

The screenshot shows the EIZO web interface with a sidebar menu on the left and a main content area on the right. The sidebar menu includes: Basic Information, Monitor Settings (highlighted), Camera Registration, Display, System, User, Log Display, Live Image Screen Settings, and Live Image Screen. The main content area is divided into three sections: Camera / Display Position, Date and Time, and Network. The Camera / Display Position section contains a table with 16 rows, each representing a camera. The Date and Time section shows the current time of the monitor as 2016/04/11 08:14:21, with time zone set to GMT and summer time (DST) set to Off. The Network section shows the IP setting method set to Manual and the IP address as 192.168.0.100.

No.	Camera Name	Model No.	Protocol	IP Address	Stream	Channel	MAC Address
1	--	--	--	--	--	--	--
2	--	--	--	--	--	--	--
3	--	--	--	--	--	--	--
4	--	--	--	--	--	--	--
5	--	--	--	--	--	--	--
6	--	--	--	--	--	--	--
7	--	--	--	--	--	--	--
8	--	--	--	--	--	--	--
9	--	--	--	--	--	--	--
10	--	--	--	--	--	--	--
11	--	--	--	--	--	--	--
12	--	--	--	--	--	--	--
13	--	--	--	--	--	--	--
14	--	--	--	--	--	--	--
15	--	--	--	--	--	--	--
16	--	--	--	--	--	--	--

Camera Registration Display Position Settings Back to top of page

Date and Time

Current Time of Monitor 2016/04/11 08:14:21

Time Zone GMT

Summer Time (DST) Off

Date and Time Back to top of page

Network

IP Setting Method Manual

IP Address 192.168.0.100

3-4. Setting Network Cameras

“Camera Registration” is used to display a list of the network cameras currently registered for a monitor. You can add or change network cameras, and reflect network camera information, etc., onto the monitor.

Attention

- You can only change network cameras that are registered.
- This cannot be used to set network camera functions. For information on setting network camera functions, see “Chapter 2 Configuring from the monitor screen” (page 9).

● To automatically detect cameras

Discover network cameras on the network automatically and register them to the system.

Attention

- Only the network cameras installed in the same subnet as the monitor are detected. If a network camera is installed in a different subnet, the camera must be registered manually (see “To manually register network cameras” (page 15)).
- For information on “Easy Setup”, refer to the Setup Manual.

Note

- The remaining number of network cameras that can be added for registration is displayed at the top of the camera detection screen.

Procedure

1. Select “Camera Registration”.

A screen displaying a list of the camera registration information appears.

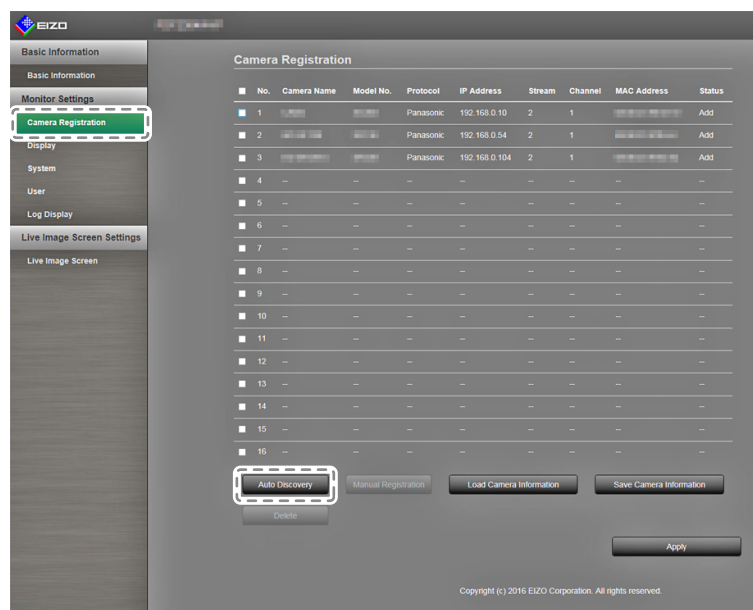

2. Select “Auto Discovery”.

A “Camera detection will start” dialog box appears.

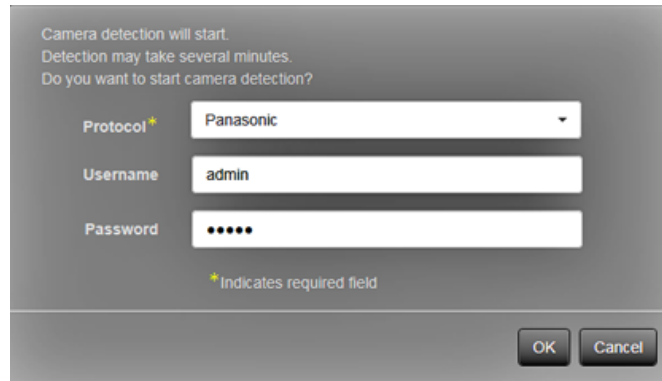

Camera detection will start.
Detection may take several minutes.
Do you want to start camera detection?

Protocol* Panasonic

Username admin

Password

*Indicates required field

OK Cancel

3. Select the “Protocol” from the list.

Enter the “Username” and “Password” registered in the network camera.

4. Select “OK”.

A “Searching...” dialog box appears, and the detected network cameras are displayed in the list of additional candidates.



Auto Discovery

3 cameras found. You can add 16 more cameras.

Add	No.	Camera Name	Model No.	Protocol	IP Address	HTTP Port	Web Page
<input checked="" type="checkbox"/>	1			Panasonic	192.168.0.10	80	Web Page
<input type="checkbox"/>	2			Panasonic	192.168.0.54	80	Web Page
<input type="checkbox"/>	3			Panasonic	192.168.0.104	80	Web Page

Add Cancel

Note

- There is a web page link in the web page field of the list of detected cameras. When you click a link, a camera web page will open in a separate window. (Address: http://(IP address):(HTTP port))
- If there are zero candidates in camera detection, nothing will display.
- If “Cancel” is selected during camera detection, a list of cameras detected up to the time of canceling will be displayed.

5. Select a camera to be added from the list of candidates, and select “Add”.

Returns to the camera registration information list screen in step 1.

6. Select “Apply”.

A setting confirmation dialog box appears.

7. Select “OK”.

● Load camera information

Importing a CSV file with the additional candidates for cameras, they can be the candidates for the network cameras discovery.

Procedure

1. Select “Camera Registration”.

A list of camera registration information appears.

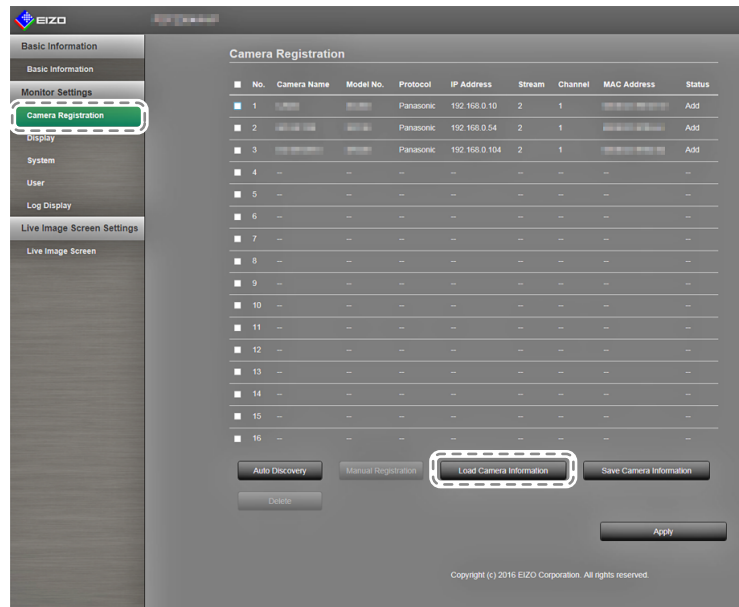

2. Select “Load camera information”.

A file dialog box opens

3. Select the CSV file that describes the network camera information, and select “Open.”

A list of the candidate network cameras appears.

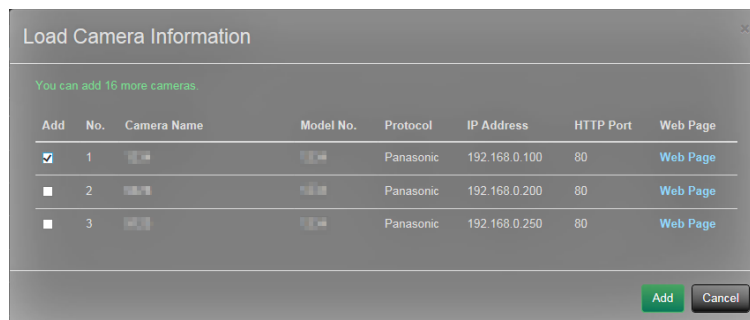

4. Select a camera to be added from the list of candidates, and select “Add”.

Returns to the camera registration information list screen in step 1.

5. Select “Apply”.

A setting confirmation dialog box appears.

6. Select “OK”.

Note

- Up to 255 candidate cameras can be read.
- The CSV files that can be read are as follows.
 - CSV files that are exported from the monitor or browser
 - CSV files created by the user
- For details on how to export CSV files, refer to “[Save Camera Information](#)” (page 53).
- When a user creates a CSV file, the following rules apply.
 - In line 1, enter the following as the item line: “CameraName, Protocol, IPAddress, Port, UserName, Password, Uri, Comm.Method”.
 - The columns are in random order.
 - Input of the “UserName, Password, Uri, Comm.Method” values is user-defined.
 - Only the specified string can be read for an item name.

```
CameraName,Protocol,IP Address,Port,UserName,Password,Uri,Comm.Method  
[redacted],Panasonic,192.168.0.100,80,admin,[redacted]  
[redacted],Panasonic,192.168.0.200,80,admin,[redacted]  
[redacted],Panasonic,192.168.0.250,80,admin,[redacted]
```

● Manual Registration of Cameras / Changing Camera Information

You can manually register cameras or modify registered information contents for cameras listed in the camera registration information list.

Attention

- If multiple selections are made for registration information of a network camera to be changed, “Manual Registration” will be disabled.

Procedure

1. Select “Camera Registration”.

A screen displaying a list of the camera registration information appears.

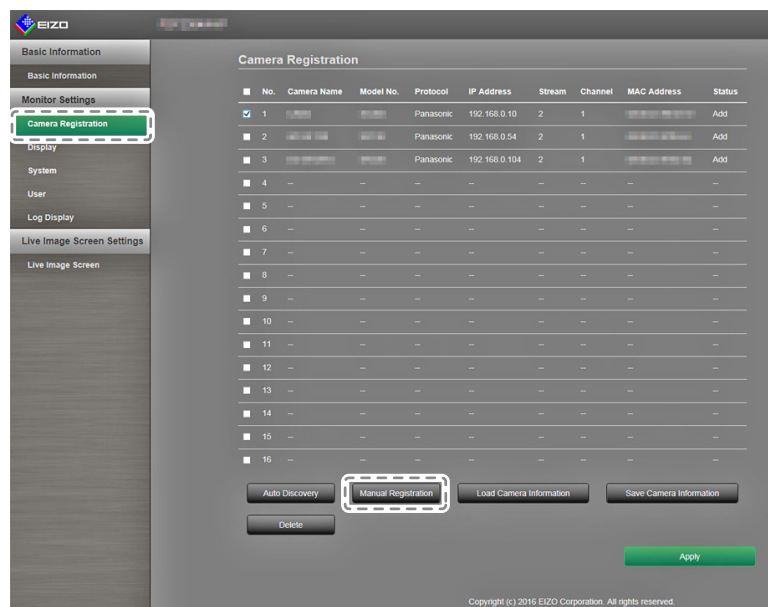

2. Put a check on the number of the camera to be registered or modified.

3. Select “Manual Registration”.

A “Camera Information Settings” dialog box appears. When a registered camera is selected, a dialog box describing the applicable camera information appears.

Item	Detail	Setting range
Camera Name	Enter the camera name. When “Obtain Camera Name” is selected, the camera name is automatically obtained from the network camera. <ul style="list-style-type: none"> • Panasonic network camera: Camera Name • AXIS network camera: Camera Name • Network camera with its “Protocol” set to “ONVIF”: Camera model number, manufacturer name, etc. 	Alphanumerics, kana, and kanji (24 characters max.)
IP Address	Enter the network camera IP address.	0.0.0.0 to 255.255.255.255
Port	Enter the network camera port number.	1 to 65535 ^{*1}
Protocol	Select the protocol for controlling the camera.	Panasonic / AXIS / ONVIF / DirectUri
Username ^{*2}	Enter the username to use when accessing network cameras.	Alphanumeric, symbols (up to 32 characters)
Password ^{*2}	Enter the password to use when accessing network cameras.	Alphanumeric, symbols (up to 32 characters)
Stream ^{*3}	Select a stream for delivering camera images. Select a stream supported by the connected network camera.	CH1 to CH4
Channel ^{*3}	Select the channel of the analog encoder. If the network camera does not support the channel function, set to “1”.	CH1 to CH4
RS485 PTZ Control ^{*3}	Controls the brightness, automatic focus adjustment, pan, tilt and zoom for devices that are connected to the network camera via a RS485 cable.	On / Off
Video Stream ^{*4}	Select the display mode for screens that display the network camera images. When “Obtain Stream” is selected, the display mode is automatically selected from the network camera.	According to the camera specification

Stream Profile*4	Select the profile that the network camera has. When "Obtain Profile" is selected, the profile is automatically selected from the network camera.	According to the camera specification
Media Profile*5	Select the ONVIF image profile. When "Obtain Profile" is selected, the profile is automatically selected from the network camera.	EIZO_Profile / camera profile
Transmission Mode*6	Select the transmission mode for camera images.	Unicast / Multicast
URI*7	Set the URI that starts with rtsp:// or rtp://.	Alphanumeric (up to 255 characters)
Comm. Method	Select the Comm. Method for camera images.	RTP over UDP*8 / RTP over RTSP

*1 If the "Protocol" is set to "DirectUri" and if the "URI" starts with rtp://, 1824 to 65534.

*2 Enter the username with administrator rights and the password.

*3 Compatible only if the "Protocol" is set to "Panasonic".

*4 Compatible only if the "Protocol" is set to "AXIS".

*5 Compatible only if the "Protocol" is set to "ONVIF".

*6 Compatible only if the "Protocol" is set to "AXIS" and "ONVIF".

*7 Compatible only if the "Protocol" is set to "DirectUri".

*8 Possible to set only "RTP over UDP" in the following cases.

- In the case where "Protocol" is set to "Panasonic".
- In the case where "Protocol" is set to "AXIS" and "Transmission Mode" is set to "Multicast".
- In the case where "Protocol" is set to "ONVIF" and "Transmission Mode" is set to "Multicast".
- In the case where "Protocol" is set to "DirectUri" and "URI" starts with rtp://

4. Set the changes, and select "OK".

Returns to the camera registration information list screen in step 1.

5. Select "Apply".

A setting confirmation dialog box appears.

6. Select "OK".

Note

- The following message is displayed when the system fails to acquire the "Obtain Camera Name" and "Obtain Profile" information. Obtain the information again.

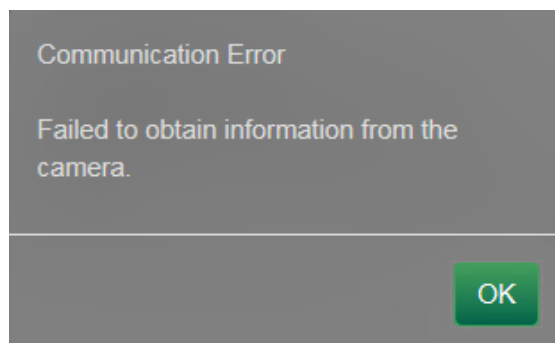

● Deleting Camera Information

You can delete the contents of the registered information for cameras.

Procedure

1. Select “Camera Registration”.

A screen displaying a list of the camera registration information appears.

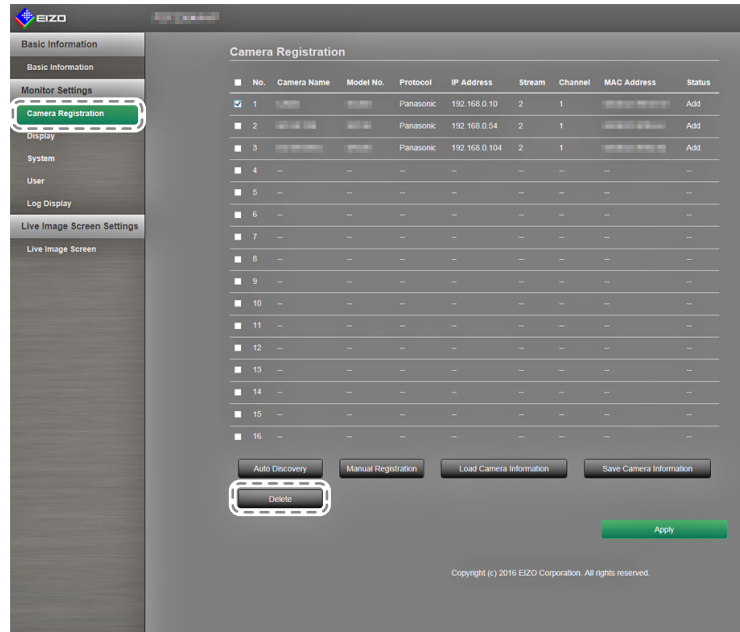

2. Check the number of the camera to be deleted.

3. Select “Delete”.

A setting confirmation dialog box appears.

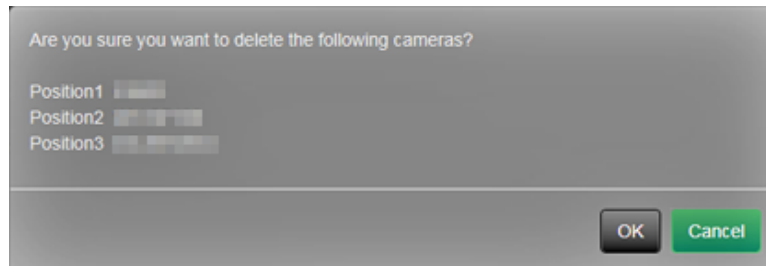

4. Select “OK”.

Returns to the screen that displays a list of the camera registration information.

5. Select “Apply”.

A setting confirmation dialog box appears.

6. Select “OK”.

● Save Camera Information

You can save the information registered in the camera registration information list to a CSV file.

When you select “Save Camera Information”, a CSV file describing the camera information displayed in the information list is exported.

File name: fdf4627wip_CameraInfo_yyyymmdd.csv
(yyyymmdd is the computer date and time.)

3-5. Setting Display Positions of Camera Images

You can configure settings such as the display positions of network cameras, and displaying camera names in the live image screen.

1. Select “Display” in the “Monitor Settings”.

A screen for display position settings is displayed. A link for each setting item that can be configured in “Display” is located at the top of the screen.

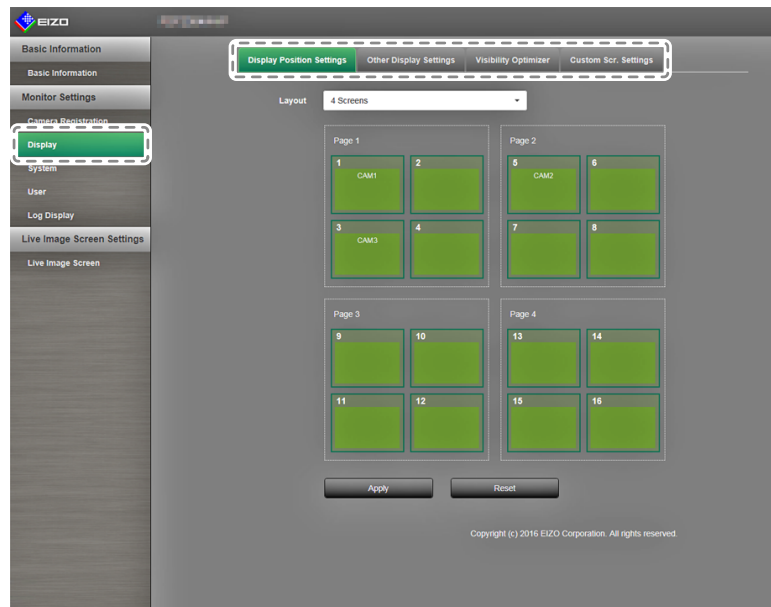

2. Select each setting item.

The target setting screen is displayed.

● Setting Display Positions

Set the positions for displaying network camera images.

You can switch the display positions of the source and destination camera images by dragging and dropping the camera within the page.

Attention

- All of the display positions of registered network cameras can be set.
-

Procedure

1. Select “Display Position Settings”.

The “Display Position Settings” screen appears.

Each of the outer frames containing the number on the page are the camera display position^{*1}, and the inner squares for the camera display position are the camera name^{*2} to be displayed.

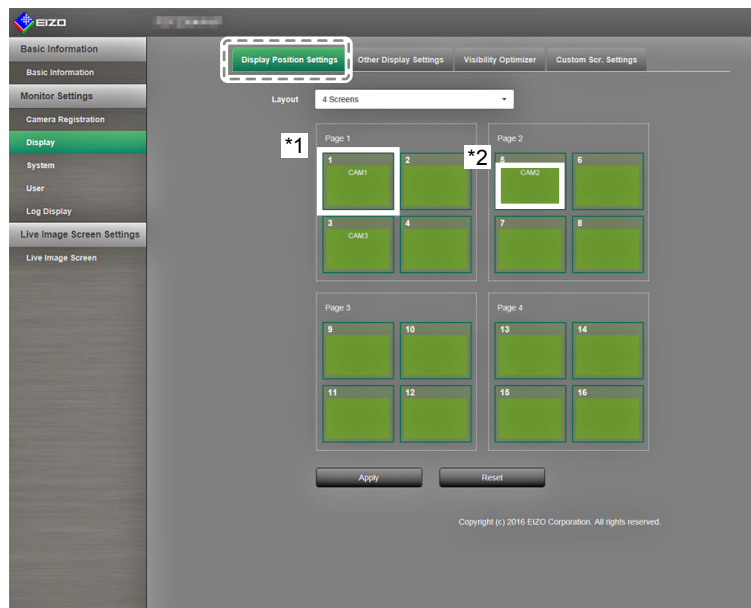

2. Select the display position layout from the list.

Select the layout from the list box. The screen changes in response to the selected layout.

Note

- When you select a layout in the list box, the display in the Page changes to the selected state. You can set the display status while imaging.
 - The initial display position when the screen is transitioned is the display position currently set for the current monitor.
 - You can switch the camera names in the inner squares by dragging and dropping them between the respective pages.
-

3. Drag a camera name and drop it on the position number where you want to display it.
The display positions of the source and destination camera images are switched.

e.g.) 4 screen layout

1. Drag display position 1 on Page 1 and drop it at display position 5 on page 2.
2. The display position 1 and display position 5 cameras are switched.
3. Only the camera name in the inner square is moved, without moving the display position of the camera image.
4. Select “Apply”. The display positions of camera images are updated.

When you select “Reset”, the information of the setting being changed is discarded, and becomes the current monitor display settings.

Note

- A camera web page link is embedded in frames that have been allocated a camera name. When you click it, a camera web page will open in a separate window.

● Other Display Settings

Set the items to be displayed in camera images.

Procedure

1. Select “Other Display Settings”.
The “Other Display Settings” screen is displayed.

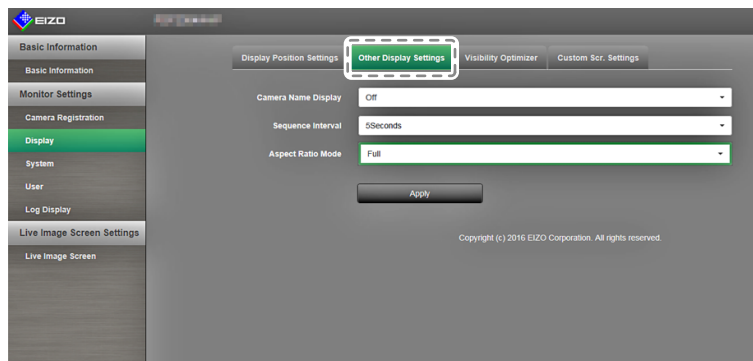

2. Configure the items.

Item	Detail	Setting range
Camera Name Display	Select to display or hide the camera name set on the monitor. (The camera name is displayed on the upper left of the image.)	On / Off
Sequence Interval	Set the interval for changing over the screen during sequential display.	5 to 60 seconds
Aspect Ratio Mode	Set which aspect ratio to apply when the aspect ratio of the video delivered from the network camera and the aspect ratio of the monitor image display area differ. If “Aspect” is selected when “Custom Screen” is selected for the “Image Layout” (page 58), you can select either “Full” or “Aspect” for each camera image.	Full / Aspect

3. Select “Apply”.
The setting complete screen is displayed. Select “OK”.

● Setting Visibility Optimizer function

Set Visibility Optimizer function for images from each camera.

Attention

- Information such as camera name will be displayed as a blank row for display positions that have not been allocated a camera. Each list box becomes invalid and will not be displayed.

Procedure

1. Select “Visibility Optimizer”.

The “Visibility Optimizer” screen is displayed.

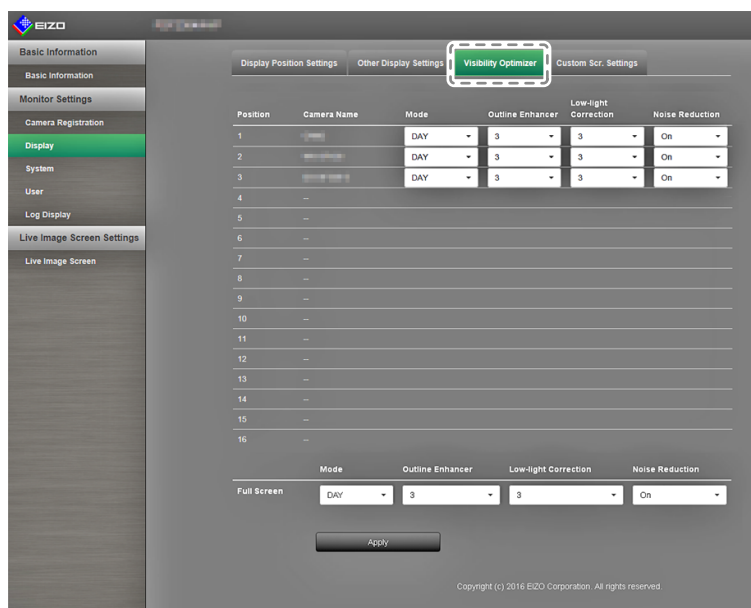

2. Set the camera of the applicable display position.

3. Configure the items.

Item	Detail	Setting range
Mode	Select the display mode to apply to the images of the selected network camera. Set to “DAY” to apply a mode suitable for general images. Set to “NIGHT” to apply a mode suitable for monochrome images such as images taken at night.	DAY / NIGHT / Off
Outline Enhancer	Adjusts the perceived resolution of images. Reduces blurring and displays images vividly and clearly.	1 to 5 / Off
Low-light Correction	Makes dark areas of images visible by analyzing the image and correcting the brightness for each pixel. This function is effective when for instance viewing images with dark areas that are not easily visible, or when using the monitor in a bright environment.	1 to 5 / Off
Noise Reduction	Reduces the amount of block noise (noise from tessellated images).	On / Off

4. Select “Apply”.

The setting complete screen is displayed. Select “OK”.

● Custom Screen Settings

This section describes the procedure for screen settings when the Custom Screen is selected for the image layout.

Procedure

1. Select “Custom Scr. Settings”.

The “Custom Scr. Settings” screen is displayed.

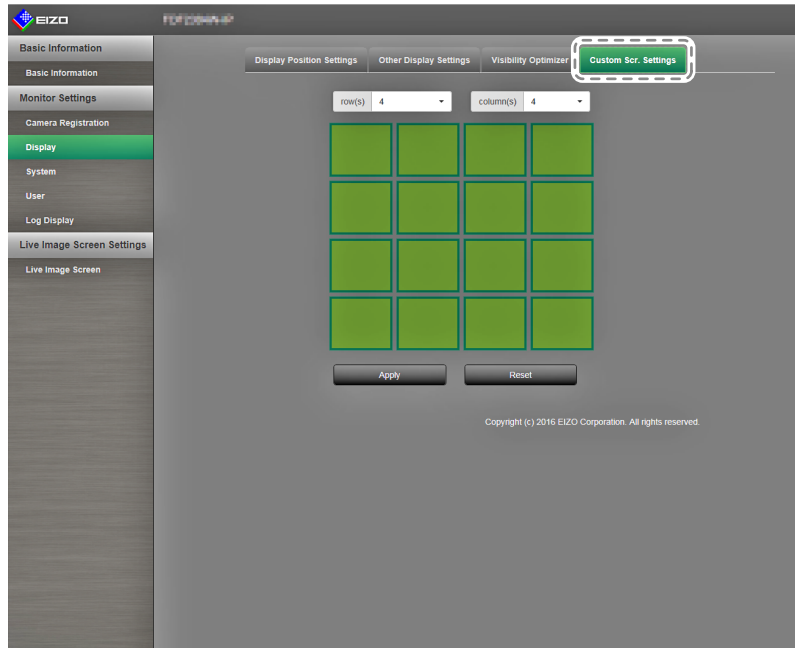

2. Select the number of columns and rows from the list box.
The screen will change to a layout with the number of columns and rows you selected.
3. Drag a camera image display position and drop it on the display position you want to couple with.
The selected display position is coupled.
4. Select “Apply”. The display position coupling is updated.
When you select “Reset”, the information of the setting being changed is discarded and the display returns to the current monitor settings.

Note

- To release the coupling, click the display position just coupled. Or, change the number of columns.
 - If “Aspect Ratio Mode” for the camera image is set to “Aspect”, you can select either “Full” or “Aspect” for each camera image. For information on the “Aspect Ratio Mode” settings, refer to [“Other Display Settings” \(page 56\)](#).
-

3-6. Configuring System Settings

Configure settings such as the date and time of this product, network settings, and maintenance.

Procedure

1. In the “Monitor Settings”, select “System”.

A link for each setting item that can be configured in the system settings is located at the top of the screen.

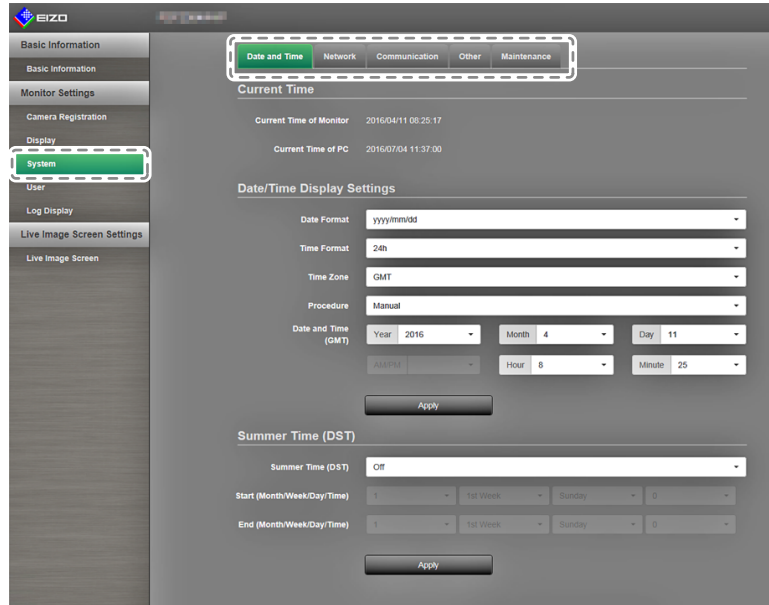

2. Select each setting item.

The screen transitions to the selected setting item.

● Date and Time

You can set the current date and time, and set summer time.

1. Select “Date and Time”.
The “Date and Time” screen is displayed.

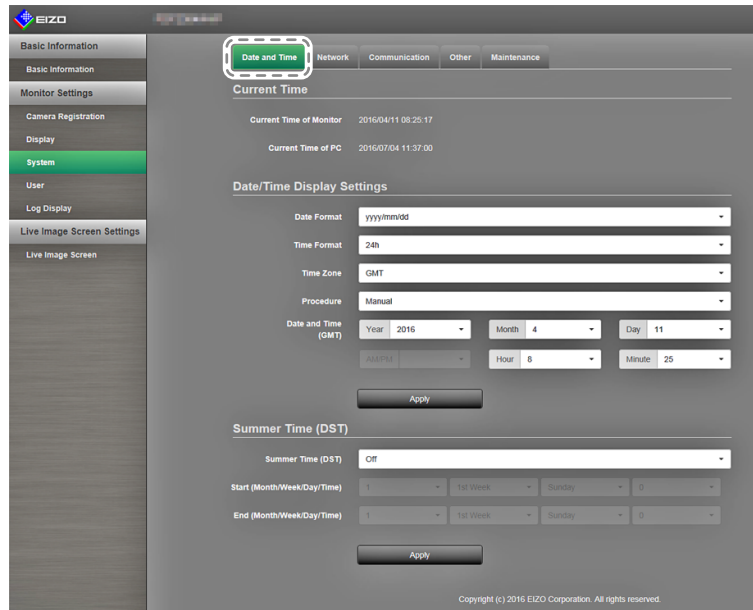

Date/Time Display Settings

Set the current date and time.

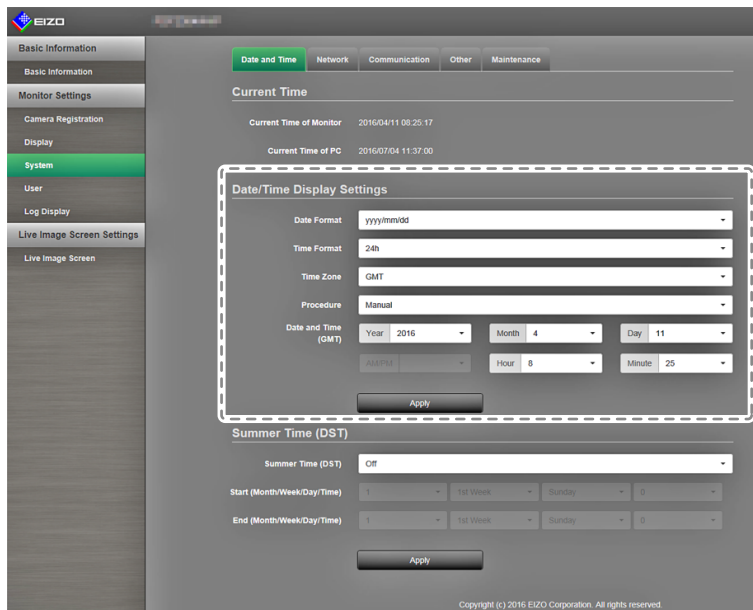

1. Configure the items.

Item	Detail	Setting range
Date / Time Display Settings	Set the date display format, time display format, and time zone (time difference with GMT*1).	yyyy/mm/dd, Mmm/dd/yyyy, dd/Mmm/yyyy, mm/dd/yyyy, dd/mm/yyyy
Time Format		24h / 12h
Time Zone		GMT-12:00 to GMT+14:00
Procedure		Manual / Synchronize with PC
Date and Time	Set the current time.	2010/1/1 0:00 to 2035/12/31 23:59

*1 Greenwich Mean Time

2. Select “Apply”.

The setting complete screen is displayed. Select “OK”.

Note

- When “Synchronize with PC” is selected in “Procedure”, the current date and time setting information of the computer is sent to the monitor and synchronized.
- If the main power switch is turned off or the power cord is unplugged for one week or longer, the monitor’s time and date display will no longer be displayed accurately.

Summer Time (DST)

Apply or cancel the summer time setting (DST).

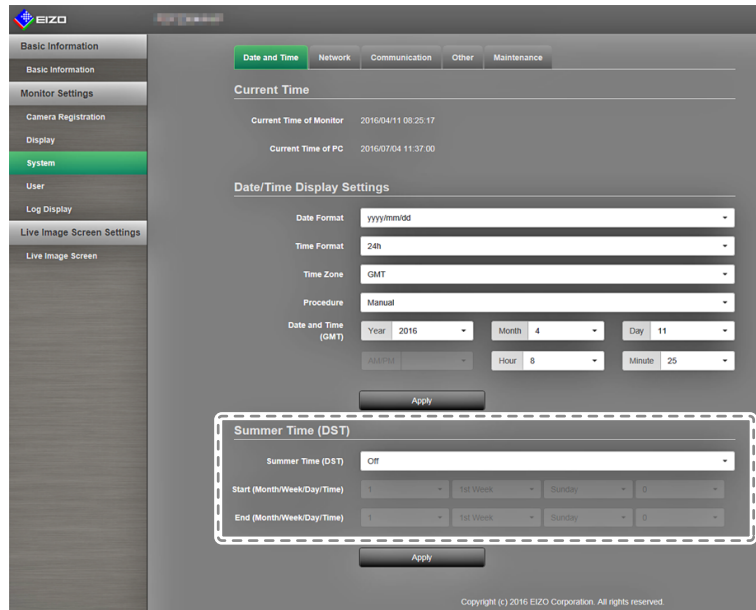

1. Configure the items.

Item	Detail	Setting range
Summer Time (DST)	Applies or cancels the summer time setting. Set to “On” to apply summer time immediately. Set to “Off” to not apply summer time. Set to “Auto” to apply summer time automatically during the period designated by the start / end dates and times.	On / Off / Auto

2. Select “Apply”.

The setting complete screen is displayed. Select “OK”.

● Network Settings

Set network information.

Attention

- When any one of the IP address settings / IP address / subnet mask / gateway is changed and “Apply” is selected, the warning message “The network settings will be changed” is displayed. Select “OK”.

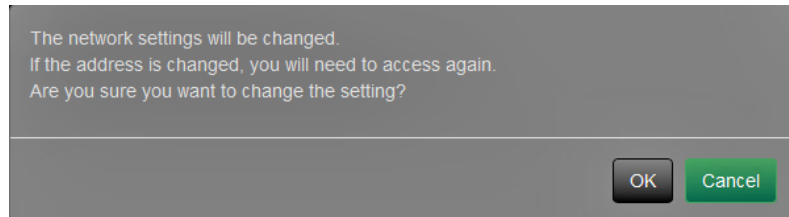

Also, when you select “OK” for the warning message, a message requesting that you access again appears.

- In “System”, select “Network Settings”.

The “Network Settings” screen is displayed.

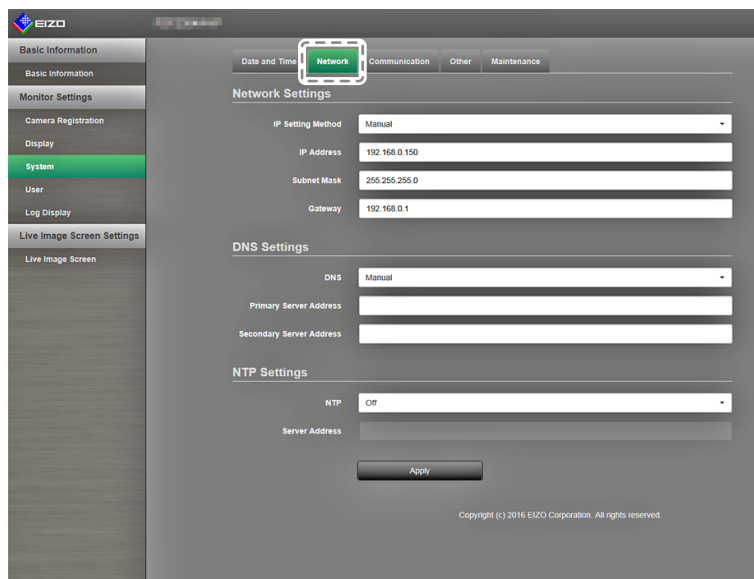

- Configure the items.

Item	Detail	Setting range	
Network Settings	Select the IP address setting method.	IP Setting Method	DHCP / Manual
	If “Manual” is selected, set the IP address, subnet mask and gateway.	IP Address, Subnet Mask, Gateway ^{*1}	0.0.0.0 to 255.255.255.255
DNS Settings	Set the DNS. (When “IP Address” in “Network Settings” is set to “Manual”)	DNS	Auto / Manual
	If you selected “Manual”, set the primary server address and the secondary server address.	Primary Server Address, Secondary Server Address	0.0.0.0 to 255.255.255.255
NTP Settings	Set whether or not to use an NTP server.	NTP	On / Off
	If you selected “On”, set the NTP server address.	Server Address	Alphanumeric, symbols

*1 If your network environment does not include a gateway, you do not need to set the “Gateway”. Use the default setting as is, or set as “0.0.0.0”.

- Select “Apply”.

The setting complete screen is displayed. Select “OK”.

● Communication Settings

The communication settings are used to configure the web interface function, detection of communication errors, and so on.

1. In “System”, select “Communication Settings”.

The “Communication Settings” screen is displayed.

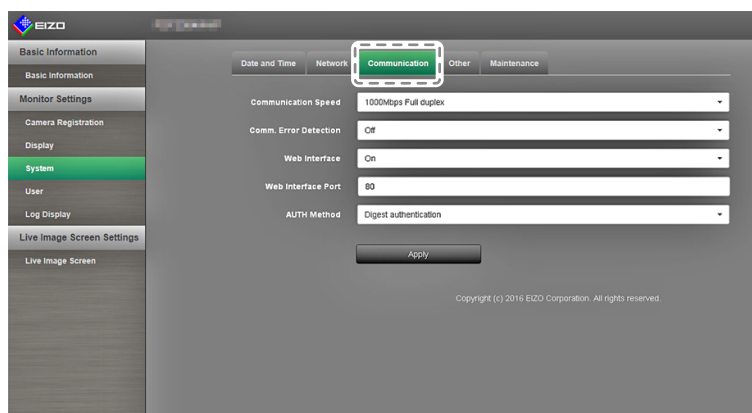

2. Configure the items.

Item	Detail	Setting range
Communication Speed	Set the communication speed between the monitor and network hub.	100Mbps Half duplex / 100Mbps Full duplex / 1000Mbps Full duplex
Communication Error Detection	You can set the following as the message to be displayed when receipt of image data stops. Communication Error Detection On: Within several seconds after receipt of image data stops, an alert message in a red box will appear on the live image screen. When communication resumes, the alert is cleared and the image is displayed again. Communication Error Detection Off: When approx. 20 seconds have elapsed after receipt of image data stops, a communication error message will appear.	On / Off
Web Interface	You can operate and configure the monitor from your web browser over the network.	On / Off ^{*1}
Web Interface Port	Sets the port of the web interface ^{*2}	1 to 65535
AUTH Method	Sets the authentication method for the web interface. ^{*2}	Digest authentication / BASIC authentication

*1 The web interface cannot be set to Off if USB lock ([page 64](#)) and Remote lock ([page 64](#)) are set to On.

*2 Can be specified when the web interface is set to On.

3. Select “Apply”.

The setting complete screen is displayed. Select “OK”.

Attention

- When the web interface is disabled, you will not be able to configure the monitor settings from your web browser. When the web interface is disabled and “Apply” is selected, the following warning message appears.

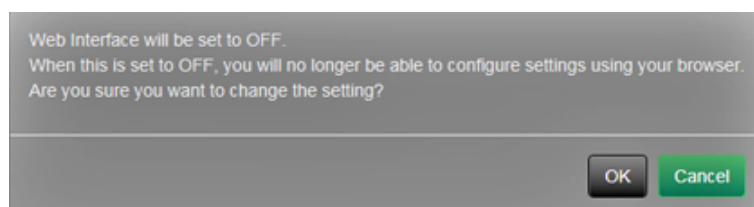

● Other System Settings

1. In “System”, select “Other System Settings”.

The “Other System Settings” screen appears.

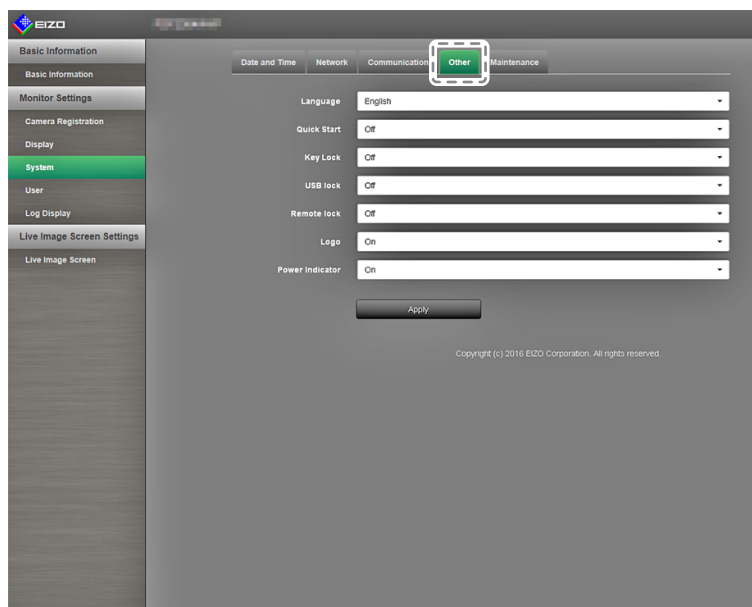

2. Configure the items.

Item	Detail	Setting range
Language	Set the display language of the menu and the setting screen.	日本語 / English / Deutsch / Polski ^{*1}
Quick Start	Set the status of the system when turned off. When set to “On”, part of the system remains running. When set to “Off”, the system is shut down completely. By setting to “On”, the startup time for this product can be reduced (approx. 10 seconds). However, do not turn off the main power of the monitor when Quick Start is set to “On” because part of the system remains running.	On / Off
Key Lock	Locks operations by the buttons on the front of the monitor.	On / Off
USB lock ^{*2,3}	Locks operations of USB devices.	On / Off
Remote lock ^{*2,4}	Locks operations from remote control.	On / Off
Logo	Set whether to display / hide the EIZO logo when the power is turned on ^{*5} .	On / Off
Power Indicator	Set whether to turn of or off the power indicator (blue) while the monitor is on.	On / Off

*1 If “Polski” is selected for HDMI signal input, the display language is set to English.

*2 USB lock and Remote lock can only be set via the web interface.

*3 When the USB lock setting is changed, the monitor needs to be restarted.

*4 This setting may not be available depending on the firmware version of the monitor.

*5 The rotating bar indicating that the system is starting up cannot be hidden.

3. Select “Apply”.

The setting complete screen is displayed. Select “OK”.

● Maintenance

Perform system initialization, restarts, software updates, and settings data migration.

1. In “System”, select “Maintenance”.

The “Maintenance” screen is displayed.

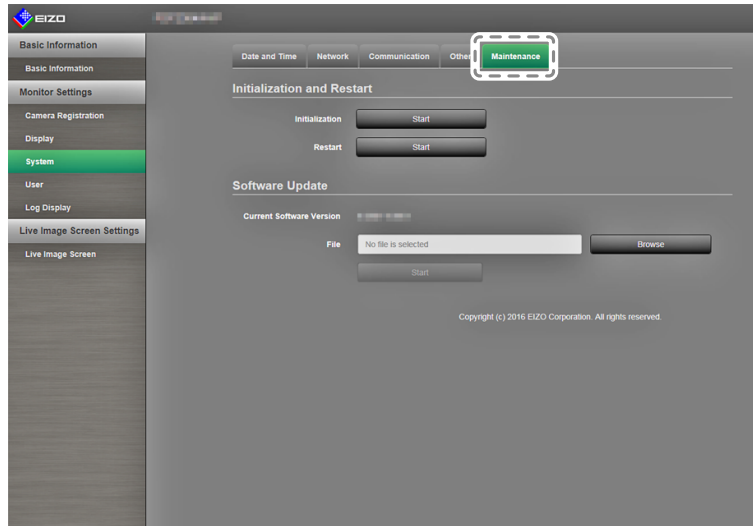

Initialization and Restart

Initialize the system

1. Select “Execute” for “Initialization”.

All settings are returned to default setting except for system logs, operation logs, the current time, time zone and summer time settings.

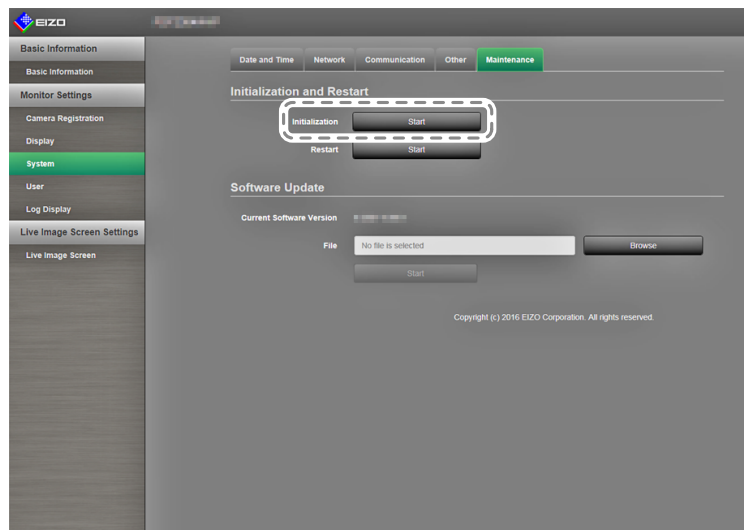

2. The following message appears.

Select “OK”.

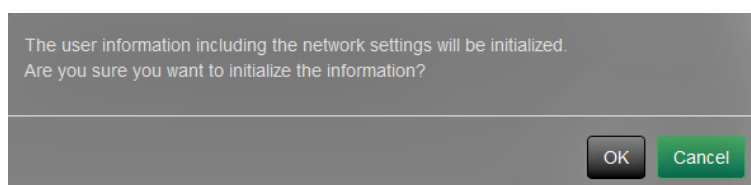

Restart the system

1. Select “Start” at “Restart”.
Restart the system.

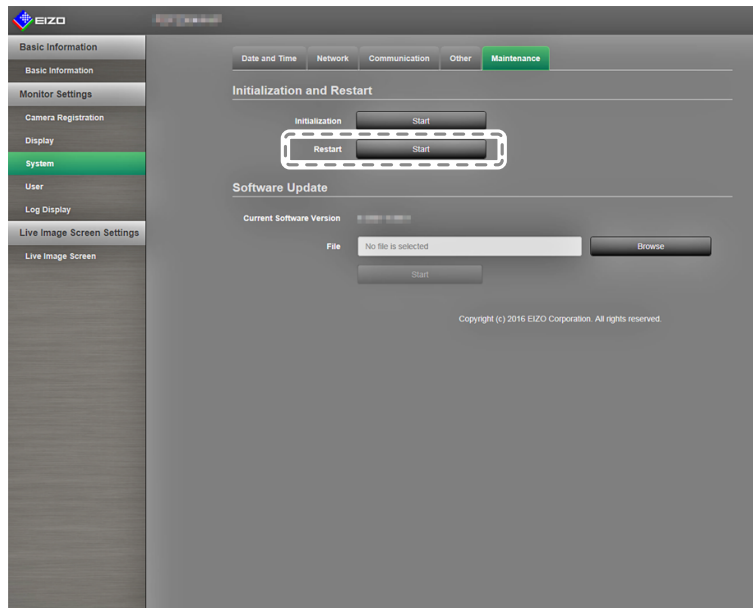

2. The following message appears.
Select “OK”.

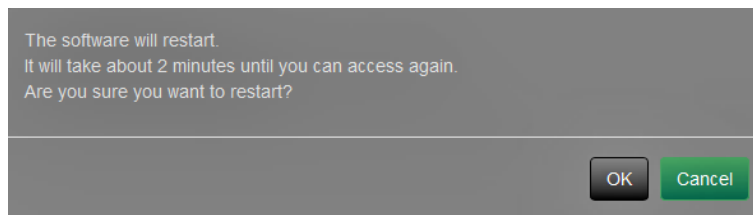

Software Update

You can both upgrade or downgrade the software version.

1. In “System”, select “Maintenance”.
The screen transitions to “Software Update”.

2. Select “Browse”.
A file selection dialog box opens. Select the applicable file.

Attention

- The software will not be updated if a file is not selected, or a file other than an update file has been selected.
 - Perform software updates with the monitor screen displayed.
-

3. Select “Execute”.
4. The following message appears.
Select “OK”.

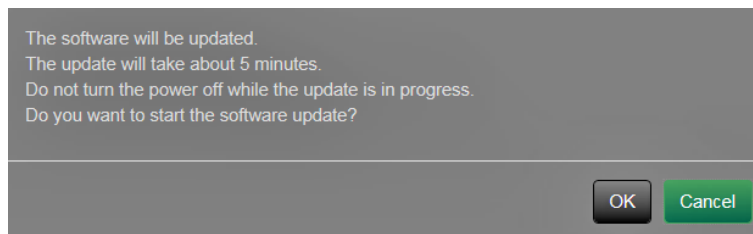

5. The update process starts, and the following message appears.
Select “OK”.

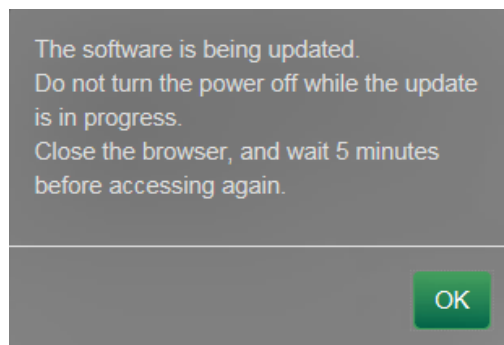

6. The software is updated.
Close the web browser, and wait 5 minutes before accessing again.

Note

- You can select update files from the File Selection screen, and can perform upgrading or downgrading of software.
 - When you restart your system, a message indicating the success or failure of the software update will appear. The message will clear automatically after 60 seconds if “OK” is not selected. However, this message will not appear if you do the update through your web browser.
-

Settings Data Migration

You can save and load the settings data to the PC.

Saving Settings Data

1. Select “Save Settings Data” on the “Settings Data Migration” screen.
The “Save Settings Data” dialog box is displayed.

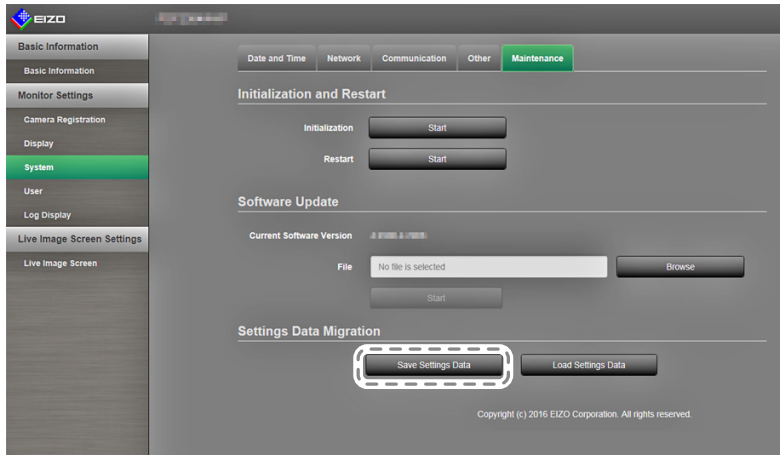

2. Enter the password.
The password is blank by default. Set the password as necessary.

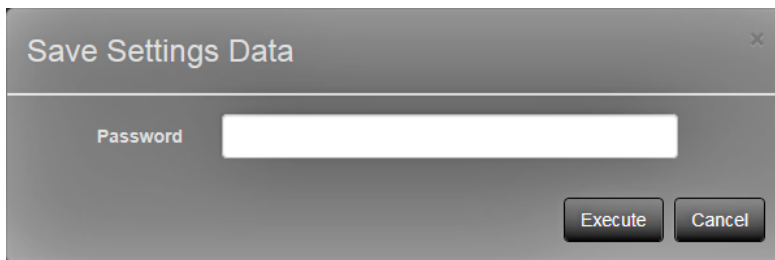

3. Select “Execute”. The settings data are saved.

Attention

- Some of the settings cannot be saved.
- If you forget the password that you specified when saving the data, you will no longer be able to load the settings.

Note

- Saved file name: Backupyyyyymmdd.duraconf (yyyyymmdd is the save date)
-

Loading Settings Data

1. Select “Load Settings Data” on the “Settings Data Migration” screen.
The “Load Settings Data” dialog box is displayed.

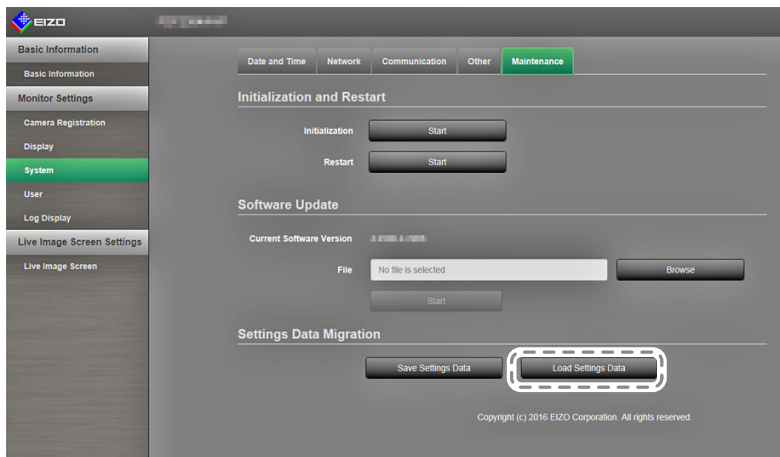

2. Select the settings data file.

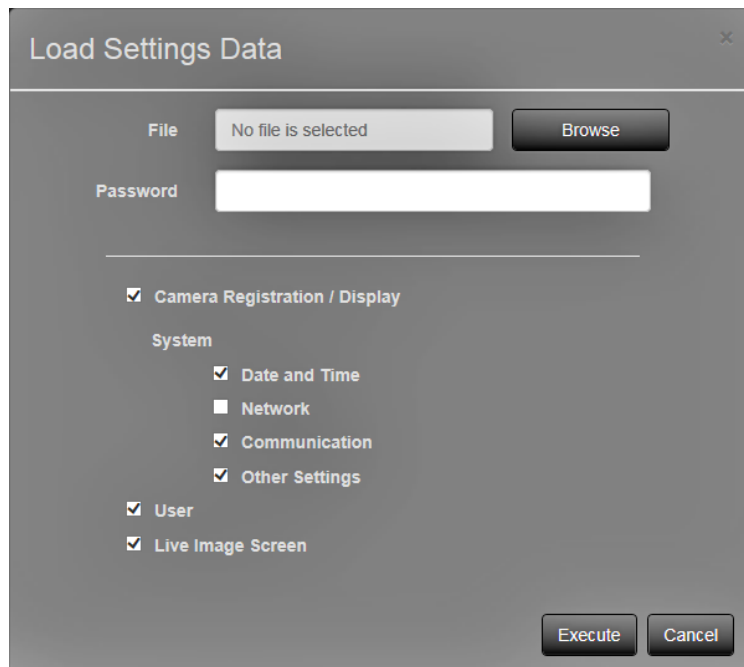

3. Enter the password that was set when saving the settings data.
4. Put a check on the information item you want to load.
5. Select “Execute”. The settings data are loaded.

6. The following message appears.

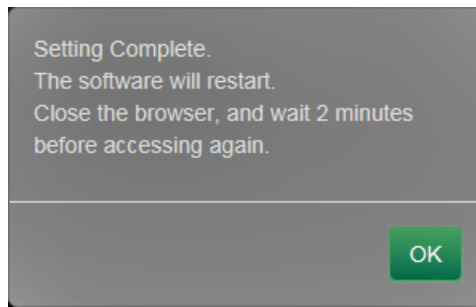

Select "OK".

Attention

- If the environment where settings data was stored is different from the environment where settings data is being loaded with respect to network settings or communication settings, you may not be able to display the Web control screen from the Web browser.
-

3-7. Setting User Information

Register, change or delete information (username, user level, and password) on users that access this product, and configure Auto Login settings.

Note

- For details, see “2-7. Setting User Information” (page 36).

● Adding User Information

Procedure

1. Select “User”.

The “User Settings” screen is displayed.

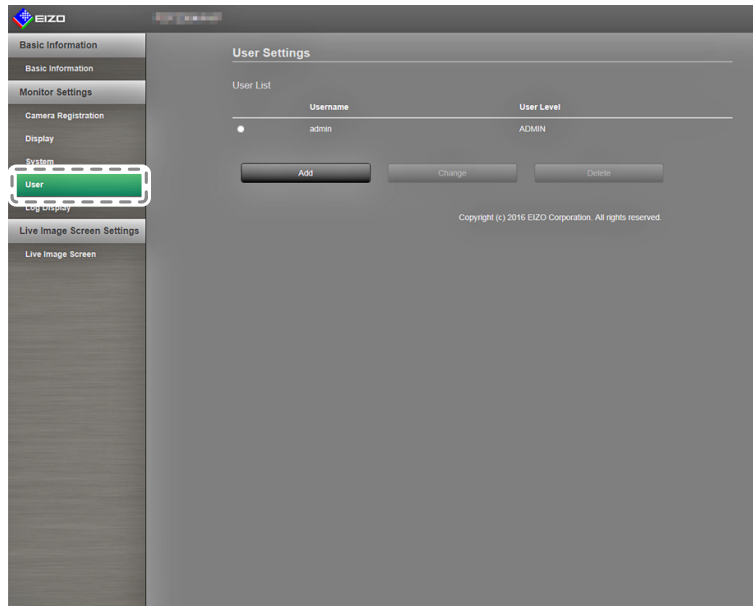

2. Select “Add”.

A dialog box for entering user information appears.

The screenshot shows a dialog box for adding a user. It has a title bar with a close button (X). The dialog contains four input fields: 'Username' (text input), 'User Level' (dropdown menu), 'Password' (text input), and 'Confirm Password' (text input). At the bottom right, there are two buttons: 'OK' and 'Cancel'.

3. Set user information.

4. Select “OK”.

The setting complete screen is displayed. Select “OK”.

● Changing User Information

Procedure

1. Select “User”.

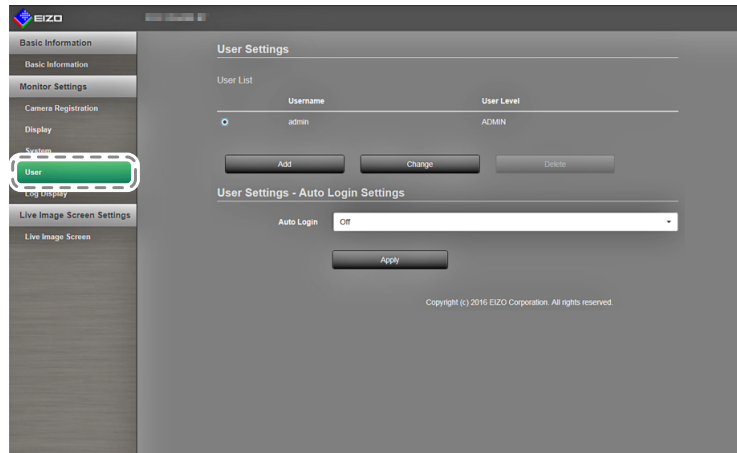

2. Select the user to be changed from the “User List”.
3. Select “Change”.
A dialog box for entering user information appears.
4. Set user information.
5. Select “OK”.
The setting complete screen is displayed. Select “OK”.

● To delete user information

Procedure

1. Select “User”.

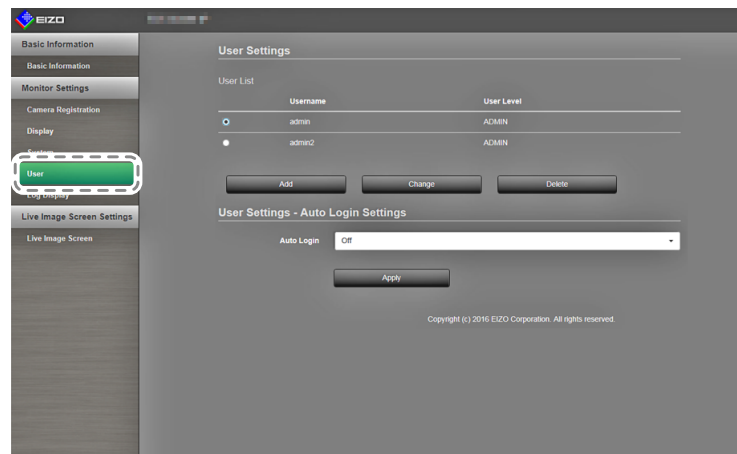

2. Select the user to be deleted from the “User List”.
3. Select “Delete”.
4. A “Are you sure you want to delete user xxx?” confirmation dialog box appears. Select “OK”.

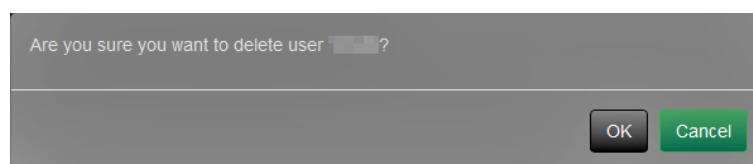

If you do not want to delete the user, select “Cancel”.

5. The setting complete screen is displayed. Select “OK”.

● Configuring Auto Login Settings

Procedure

1. Select “User”.

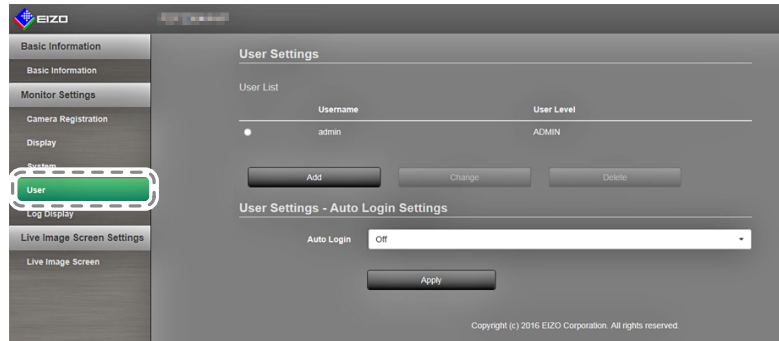

2. On the “Auto Login” screen, select users to whom the Auto Login is to be applied.
3. Select “Apply”.
The setting complete screen is displayed. Select “OK”.

3-8. Displaying Operation Logs

Operations of this product are recorded on logs. Past operation results can be checked by displaying operation logs. You can also display system logs.

Note

- The following data are recorded on the log:
 - Login information: The names of users who logged in to the system
 - Camera operation results: Name of operated camera, operation details, operation results
 - Date, time and details of changes confirmed by selecting “Apply” on setting screens
- Logs older than two months are automatically deleted at 04:00:00 AM on the first day of every month.

● Displaying logs

Procedure

1. Select “Log Display”.

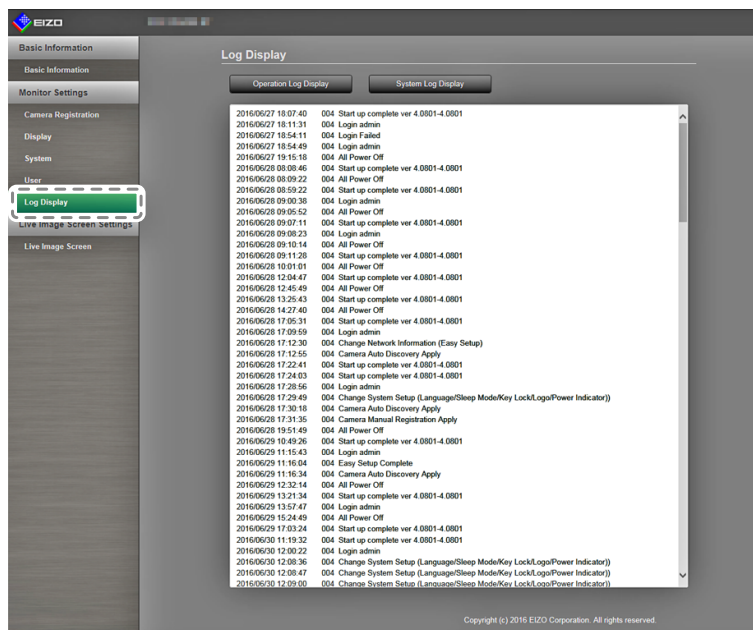

2. Select “Operation Log Display”.

The log data is displayed in the area at the bottom of the screen.

● Displaying the system log

Procedure

1. Select “Log Display”.
2. Select “System Log Display”.

The log data is displayed in the area at the bottom of the screen.

3-9. Setting the Live Image Screen

The live image screen settings are used for changing the live image screen layout, or the present monitor status.

Procedure

1. In “Live Image Screen”, select “Live Image Screen Settings”.

A link for each setting item that can be configured in the live screen settings is located at the top of the screen.

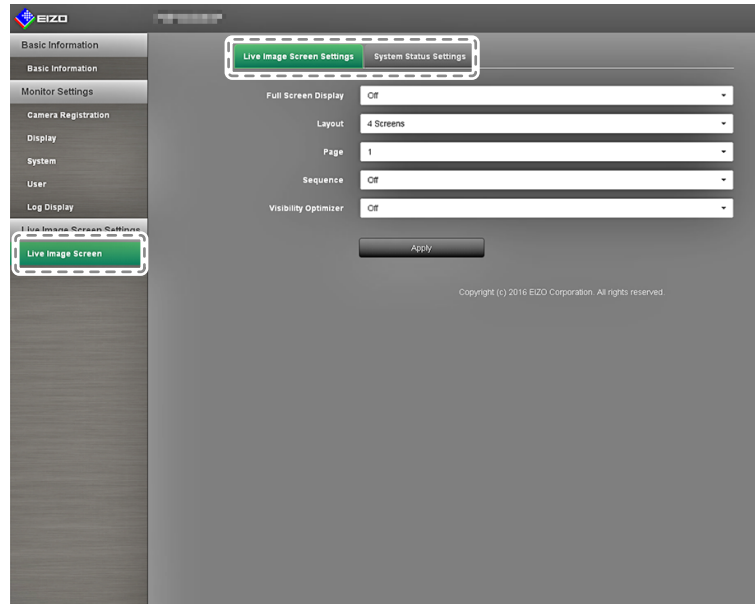

2. Select each setting item.

The target setting screen is displayed.

● Live Image Screen Settings

The live image screen settings are used for configuring the display, such as changing the live image screen layout.

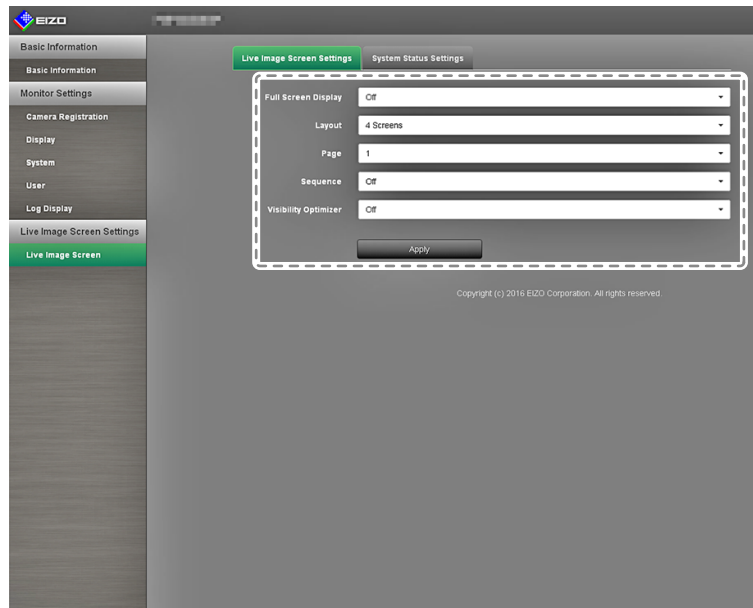

1. Select each setting item from the list box.

Item	Detail	Setting range
Full Screen Display	Displays / hides the menu of the live image screen.	On / Off
Layout	Changes the monitor screen layout. You can switch to 1 screen, 3 screen, 4 screen, 9 screen, 16 screen, 8 screen or Custom Screen layout.	1 Screen / 3 Screens 4 Screens / 9 Screens / 16 Screens / 8 Screens / Custom Screen
Page	Changes over the page of camera images to display on the monitor.	1 to 16
Sequence	Turns the sequential display of camera images on or off.	On / Off
Visibility Optimizer	Turns Visibility Optimizer function on or off.	On / Off

2. Select "Apply".
3. The setting completion screen appears. Select "OK".

● System Status Settings

Sets the current monitor screen display status and brightness.

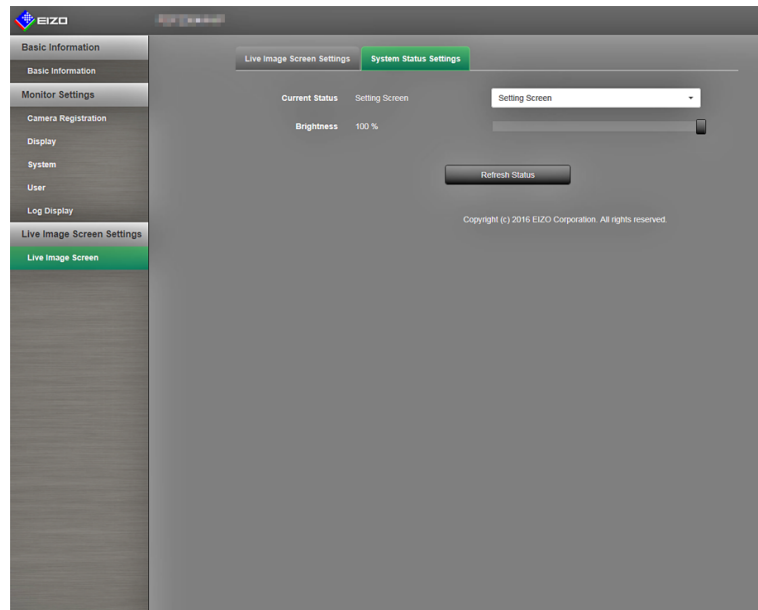

Current Status

Adjusts the current monitor screen display status.

1. Click ▼ next to “Current Status” to select the status from the displayed list.

The following statuses are displayed.

Item	Status
Live Image Screen	Monitor showing live screen
Setting Screen	Monitor showing setting screen
HDMI Port Display	Display status of the monitor HDMI port.
Quick Shutdown	Quick-start is on, and the power is off.

2. Select “Refresh Status”.

Applies the latest status on the monitor.

Attention

- When Quick Shutdown is selected:
A setting error occurs and a “Quick Start is set to OFF. Run after setting Quick Start to ON.” message is displayed.

Brightness

Adjusts the brightness of the monitor screen.

1. Move the camera “Brightness” slider to the left and right.
Changes the brightness of the monitor screen.
2. “Select “Refresh Status”.
Applies the latest status on the monitor.

Note

- You can change the Brightness on the monitor screen in the same manner as when pressing the (BRIGHT+ , BRIGHT-) buttons on the remote control. A “Setting Complete” or “Setting Failed” message is not displayed after changing the brightness.

Chapter 4 Troubleshooting

4-1. Imaging problems

Problem	Possible cause and remedy
<p>1. The display images are not smooth / camera images are not displayed (when camera images are being displayed)</p>	<ul style="list-style-type: none"> • Reduce the resolution and / or bit rate set for the network camera (see “Video Settings” (page 18)). • Check whether the used hubs and network cables are appropriate for handling the amount of information transmitted. • Move to the setting screen and return to the live image screen. Set “Quick Start” to “OFF”, turn off the power to the monitor, and, after several seconds, turn on the power to the monitor again.
<p>2. The camera images are not displayed correctly for about one or two minutes after the monitor power is turned on (when camera images are being displayed)</p>	<ul style="list-style-type: none"> • When the main power is turned off and immediately back on, images may not be displayed properly for the first few minutes. However, the display will normalize after a few minutes.
<p>3. The time of the network camera and the time of the monitor do not match (when camera images are being displayed)</p>	<ul style="list-style-type: none"> • Synchronize the time of the camera and the monitor through the setting screen (see “Clock Settings” (page 18)).
<p>4. Images are displayed upside down (when camera images are being displayed)</p>	<ul style="list-style-type: none"> • Turn the network camera upside down through the setting screen (see “Other” (page 23)).
<p>5. When the orientation of the network camera is changed to the horizontal direction (pan motion), the camera moves in the opposite direction</p>	<ul style="list-style-type: none"> • Turn the network camera upside down through the setting screen (see “Other” (page 23)).
<p>6. The settings set on the setting screen are not reflected on the camera images</p>	<ul style="list-style-type: none"> • Check whether the setting details are within the setting range of the network camera.
<p>7. An error message “E**-**” is displayed at the camera image display area</p>	<ul style="list-style-type: none"> • When Communication failed (E01-**) <ul style="list-style-type: none"> - A number of devices exceeding the allowable number of devices for simultaneous connection may be connected to the network camera. Disconnect other network devices accessing the camera or reduce the resolution of the camera (see “Video Settings” (page 18)). • When Communication failed (E02-**) <ul style="list-style-type: none"> - Check whether a network cable is connected properly. - Check whether the network camera is turned on. - Check whether the user name and password for the camera are set correctly. • When Communication failed (E03-**) <ul style="list-style-type: none"> - Network bandwidth may be overwhelmed or the display capability of this product may have been exceeded. Reduce the resolution and / or bit rate set for the network camera (see “Video Settings” (page 18)). • When in Unsupport resolution (E04-**) <ul style="list-style-type: none"> - A resolution with which this product is not compatible may be set. Try changing the resolution of the network camera. • When Compression no match (E05-**) <ul style="list-style-type: none"> - The format of streaming delivered from the network camera may be different. Check the settings of the camera and monitor, then restart the monitor. • When Unapproved parameter (E06-**) <ul style="list-style-type: none"> - The Multicast setting may not be set correctly. Check the settings of the camera.

Problem	Possible cause and remedy
8. A “** Camera Control Error” message is displayed at the message display area	<ul style="list-style-type: none">• The network camera may not be equipped with the function operated. Check the specifications of the camera.
9. The screen is whitish or blackish (for HDMI input)	<ul style="list-style-type: none">• Change the “Color Space” setting (For details, refer to the Setup Manual.).

4-2. Setting Problems

Problem	Possible cause and remedy
1. Network camera is not detected automatically	<ul style="list-style-type: none"> • In some cases, automatic discovery and camera IP address setting become inoperable when 20 or more minutes have passed since the network camera was started up. Restart the camera or register manually (see “To manually register network cameras” (page 15)). • Network cameras installed in subnets other than the monitor subnet cannot be discovered automatically. Register the camera manually. Auto discovery and camera operation may fail when the date and time of the network camera and monitor are not aligned. Use the software provided with the camera to adjust the date and time. • If using a network camera that is compatible with the “ONVIF” protocol, auto discovery cannot be performed if the ONVIF function is disabled on the camera. Check the settings of the camera.
2. An IP address of an automatically discovered network camera cannot be changed	<ul style="list-style-type: none"> • In some cases, automatic discovery and camera IP address setting become inoperable when 20 or more minutes have passed since the network camera was started up. Restart the camera or register manually (see “To manually register network cameras” (page 15)). • If using anything other than a Panasonic network camera, network settings cannot be changed from this monitor.
3. Only one camera is recognized when using a video encoder that supports multiple channels	<ul style="list-style-type: none"> • Manually register the number of channels that will be used. (see “To manually register network cameras” (page 15)).
4. A communication error message is displayed when “Apply” is selected for network camera manual registration	<ul style="list-style-type: none"> • There may be a problem with network camera communication. Check the network connection status and camera registration details.
5. Network camera does not respond to pan / tilt / zoom operations	<ul style="list-style-type: none"> • The network camera may not support pan / tilt / zoom functions. Check the specifications of the camera.
6. Cannot register a new user	<ul style="list-style-type: none"> • Duplicate usernames cannot be registered. • Only up to 10 users can be registered. Check whether 10 users have already been registered (see “2-7. Setting User Information” (page 36)).
7. Cannot delete a user	<ul style="list-style-type: none"> • There must be at least one user with a level of “ADMIN”. A user cannot be deleted if the user is the only one registered with a level of “ADMIN”. Check the registered user information (see “2-7. Setting User Information” (page 36)).
8. Forgot username and password	<ul style="list-style-type: none"> • The information of usernames and passwords can be returned to default settings by pressing a combination of buttons on the remote control (see “2-7. Setting User Information” (page 36)).
9. Cannot communicate with the camera	<ul style="list-style-type: none"> • Check the settings of the network camera and the monitor system. For details, contact your system administrator.
10. Cannot save log data to a USB storage device	<ul style="list-style-type: none"> • This product supports only FAT32 format.
11. The date and time are not displayed correctly	<ul style="list-style-type: none"> • If the main power switch is turned off or the power cord is unplugged for one week or longer, the monitor’s date and time display will become inaccurate. In such a case, set the date and time again (see “2-6. Configuring System Settings” (page 26)).

Chapter 5 Reference

5-1. List of setting items

Note

- Some settings may not be available depending on the firmware version of the monitor.
- The setting items and values differ according to the camera.

Setting item				Setting	Default setting		
Easy Setup*1	Easy Setup	Date and Time Settings	Date/Time Display Settings	Date Format	yyyy/mm/dd Mmm/dd/yyyy dd/Mmm/yyyy mm/dd/yyyy dd/mm/yyyy	yyyy/mm/dd	
				Time Format	24h 12h	24h	
				Time Zone	GMT-12:00 GMT-11:00 GMT-10:00 GMT-09:30 GMT-09:00 GMT-08:00 GMT-07:00 GMT-06:00 GMT-05:00 GMT-04:30 GMT-04:00 GMT-03:30 GMT-03:00 GMT-02:00 GMT-01:00 GMT GMT+01:00 GMT+02:00 GMT+03:00 GMT+03:30 GMT+04:00 GMT+04:30 GMT+05:00 GMT+05:30 GMT+05:45 GMT+06:00 GMT+06:30 GMT+07:00 GMT+08:00 GMT+08:45 GMT+09:00 GMT+09:30 GMT+10:00 GMT+11:00 GMT+11:30 GMT+12:00 GMT+12:45 GMT+13:00 GMT+14:00	GMT	
			Clock Setting	Year	2010 to 2035		
				Month	1 to 12		
				Day	1 to 31 1 to 30 1 to 28 1 to 29		
				Hour	AM/PM (24h) 0 to 23 (12h) 1 to 12		
				Minute	0 to 59		
			Network Settings	IP Setting Method		DHCP / Manual Setting	Manual Setting
				IP Address		0.0.0.0 to 255.255.255.255	192.168.0.150
				Subnet Mask		0.0.0.0 to 255.255.255.255	255.255.255.0
				Gateway		0.0.0.0 to 255.255.255.255	192.168.0.1

		Setting item		Setting	Default setting
Easy Setup ¹	Easy Setup	Camera Auto Discovery	Camera Discovery	Panasonic / AXIS / ONVIF	(None)
		Display Position Settings			
Camera	Auto Discovery Manual Registration	Camera Discovery		Panasonic / AXIS / ONVIF	(None)
		Camera Name		Alphanumeric characters (0 to 24 characters)	(None)
		IP Address		0.0.0.0 to 255.255.255.255	(None)
		HTTP Port		1 to 65535	(None)
		Protocol		Panasonic / AXIS / ONVIF / DirectUri ²	(None)
		Stream		1 to 4	(None)
		Channel		1 to 4	(None)
		RS485 PTZ Control		On / Off	Off
		Username		Alphanumeric characters and symbols (0 to 32 characters)	admin
		Password		Alphanumeric characters and symbols (0 to 32 characters)	12345
		Comm. Method ²		RTP over UDP / RTP over RTSP	RTP over UDP
		URI ²		Alphanumeric characters (0 to 255 characters)	(None)
		Function Settings ¹	Camera Information Display Settings/Clock Settings	Camera Information Display	
Time Display				12h / 24h / Off	(According to the camera specification)
Display Position				Upper Left / Upper Right / Lower Left / Lower Right	(According to the camera specification)
Synchronize with Monitor Time					
Video Settings (When using a Panasonic network camera)	Aspect Ratio		Camera imaging mode	(According to the camera specification)	
	Resolution		According to the camera specification	(According to the camera specification)	
	Refresh Interval		0.2s / 0.33s / 0.5s / 1s / 2s / 3s / 4s / 5s	(According to the camera specification)	
	Transmission Priority		Constant Bit Rate / Frame Rate / Best Effort	(According to the camera specification)	
	Frame Rate		1fps / 3fps / 5fps / 7.5fps / 10fps / 12fps / 15fps / 20fps / 30fps	(According to the camera specification)	
	Bit Rate (Max.)		64kbps / 128kbps / 256kbps / 384kbps / 512kbps / 768kbps / 1024kbps / 1536kbps / 2048kbps / 3072kbps / 4096kbps / 8192kbps	(According to the camera specification)	
	Bit Rate (Min.)		64kbps / 128kbps / 256kbps / 384kbps / 512kbps / 768kbps / 1024kbps / 1536kbps / 2048kbps / 3072kbps / 4096kbps / 8192kbps	(According to the camera specification)	
	Image Quality		Low (prioritize motion) / Normal / Fine (prioritize image quality)	(According to the camera specification)	
Video Settings (When using a AXIS network camera)	Video Stream		According to the camera specification	(According to the camera specification)	
	Stream Profile		According to the camera specification	(According to the camera specification)	
	Compression Format		H.264 (Fixed)	(According to the camera specification)	
	Resolution		According to the camera specification	(According to the camera specification)	
	Frame Rate		According to the camera specification (Maximum possible values 30fps)	(According to the camera specification)	
	Rotation		According to the camera specification	(According to the camera specification)	
	GOP Length		I-frame Interval (only when H.264 is selected)	(According to the camera specification)	

		Setting item	Setting	Default setting	
Camera	Function Settings ^{*1}	Video Settings (When using a AXIS network camera)	Bit Rate (Max.)	According to the camera specification (Maximum possible values 8192 kbps)	(According to the camera specification)
			Priority	None / Frame Rate / Quality	(According to the camera specification)
			Transmission Mode	Unicast / Multicast	Unicast
			Multicast Address	224.0.0.0 to 239.255.255.255	(According to the camera specification)
			Multicast Port	1824 to 65534 even numbers only	(According to the camera specification)
			Multicast TTL	1 or higher	(According to the camera specification)
		Video Settings (ONVIF Profile S-compatible network cameras)	Media Profile	EIZO_Profile / camera profile	(According to the camera specification)
			Encoder	According to the camera specification	(According to the camera specification)
			Compression Format	H.264 / MJPEG	(According to the camera specification)
			Resolution	According to the camera specification	(According to the camera specification)
			Frame Rate	1fps to 30fps	(According to the camera specification)
			Encoding Interval	According to the camera specification	(According to the camera specification)
			Bit Rate (Max.)	0kbps to 8192kbps	(According to the camera specification)
			Video Quality	According to the camera specification	(According to the camera specification)
			GOV Length	According to the camera specification	(According to the camera specification)
			H.264 Profile	Baseline / Main / Extended / High	(According to the camera specification)
			Transmission Mode	Unicast / Multicast	Unicast
			Multicast Address	224.0.0.0 to 239.255.255.255	(According to the camera specification)
			Multicast Port	1824 to 65534 even numbers only	(According to the camera specification)
			Multicast TTL	1 or higher	(According to the camera specification)
		Video Settings ^{*3}	URI	Alphanumeric characters (0 to 255 characters)	(None)
	Port		1 to 65535	(None)	
	Comm. Method		RTP over UDP / RTP over RTSP	RTP over UDP	
	Preset	Preset No.	1 to 256	(None)	
		Brightness			
		Focus			
		Zoom			
		Pan/Tilt			
	Other	Pan/Tilt-flip	On / Off	(According to the camera specification)	
		Upside-down	On / Off	(According to the camera specification)	
		Indicator	On / Off	(According to the camera specification)	
	Display	Position	Position	1 to 16	(Current setting)
			Camera Name Display	On / Off	Off
Sequence Interval			5s to 60s	5s	
Aspect Ratio Mode			Full / Aspect	Full	
Visibility Optimizer		Mode	DAY / NIGHT / Off	DAY	
		Outline Enhancer	1 to 5 / Off	3	
		Low-light Correction	1 to 5 / Off	3	
		Noise Reduction	On / Off	On	

Setting item				Setting	Default setting		
System	System Settings	Date and Time	Date/Time Display Settings	Date Format	yyyy/mm/dd Mmm/dd/yyyy dd/Mmm/yyyy mm/dd/yyyy dd/mm/yyyy	yyyy/mm/dd	
				Time Format	24h 12h		24h
				Time Zone	GMT-12:00 GMT-11:00 GMT-10:00 GMT-09:30 GMT-09:00 GMT-08:00 GMT-07:00 GMT-06:00 GMT-05:00 GMT-04:30 GMT-04:00 GMT-03:30 GMT-03:00 GMT-02:00 GMT-01:00 GMT GMT+01:00 GMT+02:00 GMT+03:00 GMT+03:30 GMT+04:00 GMT+04:30 GMT+05:00 GMT+05:30 GMT+05:45 GMT+06:00 GMT+06:30 GMT+07:00 GMT+08:00 GMT+08:45 GMT+09:00 GMT+09:30 GMT+10:00 GMT+11:00 GMT+11:30 GMT+12:00 GMT+12:45 GMT+13:00 GMT+14:00		GMT
			Clock Setting	Year	2010 to 2035		
				Month	1 to 12		
				Day	1 to 31 1 to 30 1 to 28 1 to 29		
				Hour	AM/PM (24h) 0 to 23 (12h) 1 to 12		
				Minute	0 to 59		
			Summer Time (DST)	Summer Time (DST)		On / Off / Auto	Off
					Start	Month, Week, Day, Hour	(None)
		End			Month, Week, Day, Hour	(None)	
		Network	Network Settings	IP Setting Method	DHCP / Manual Setting	Manual Setting	
				IP Address	0.0.0.0 to 255.255.255.255	192.168.0.150	
				Subnet Mask	0.0.0.0 to 255.255.255.255	255.255.255.0	
				Gateway	0.0.0.0 to 255.255.255.255	192.168.0.1	

Setting item				Setting	Default setting		
System	System Settings	Network	DNS Settings	DNS	Auto / Manual	Manual	
				Primary Server Address	0.0.0.0 to 255.255.255.255	(None)	
				Secondary Server Address	0.0.0.0 to 255.255.255.255	(None)	
			NTP Settings	NTP	On / Off	Off	
				Server Address	Alphanumeric characters and symbols	(None)	
				Communication Speed	100Mbps Half duplex / 100Mbps Full duplex / 1000Mbps Full duplex	(current setting)	
		Communication Settings	Communication Error Detection	On / Off	Off		
			Web Interface	On / Off	On		
			Web Interface Port	1 to 65535	80		
			AUTH Method	Digest authentication / BASIC authentication	Digest authentication		
			Other	Language	日本語 / English / Deutsch / Polski ⁴	English	
		Quick Start		On / Off	Off		
		Key Lock		On / Off	Off		
		USB lock ^{*2}		On / Off	Off		
		Remote lock ^{*2}		On / Off	Off		
		Logo		On / Off	On		
		Power Indicator		On / Off	On		
		Initialization					
		Restart					
		Settings Data Migration	Save Settings Data ^{*1}				
			Load Settings Data ^{*1}				
		Software Update					
	Troubleshooting	Connection Confirmation	Camera Name				
			ping				
			traceroute				
		System Log	Date (GMT)				
			Display				
			Save to USB Storage ^{*1}				
	Remove USB Storage ^{*1}						
	User ^{*5}	New User Registration	Username			Alphanumeric characters (1 to 16 characters)	(None)
			User Level			ADMIN / CAMERA CONTROL / LIVE	(None)
			Password			Alphanumeric characters (1 to 16 characters)	(None)
			Confirm Password			Alphanumeric characters (1 to 16 characters)	(None)
		Change/Delete User Information	Username			(Registered user)	(None)
New Username			Alphanumeric characters (1 to 16 characters)	(None)			
New User Level			ADMIN / CAMERA CONTROL / LIVE	(None)			
New Password			Alphanumeric characters (0 to 16 characters)	(None)			
Confirm New Password			Alphanumeric characters (0 to 16 characters)	(None)			

Setting item			Setting	Default setting	
System	User* ⁵	Auto Login	Auto Login	On / Off	Off
			Username	(Registered user)	(None)
			UserLevel	ADMIN / CAMERA CONTROL / LIVE	(None)
	Log Display	Date (GMT)			
		Display			
		Save to USB Storage* ¹			
		Remove USB Storage* ¹			

*1 This can only be set from the monitor screen. This is not available through your web browser.

*2 Can only be set and confirmed from the web browser. This cannot be set or confirmed from the monitor screen.

*3 Settings are possible for the network camera registered with "Protocol" set to "DirectUri" in the Web browser.

*4 If "Polski" is selected for HDMI signal input, the display language is set to English.

*5 The following user information is set as the default setting:
Username: "admin", Password: "admin", User Level: "ADMIN"

Chapter 6 Glossary

Bit Rate

Displays the volume of data flowing across the network. Generally, the volume is expressed with the unit “bps” (bits per second) which indicates the number of data bits transmitted per second.

DNS (Domain Name Server)

A server used to convert addresses such as “www.eizoglobal.com” into IP addresses.

Firewall

A system to prevent invasion from external networks.

H.264

A format for compressing images. This method is widely used for image remote transmission and recording. The portion with movement is predicted based on the data of the frame immediately before and after, and only the differential data between frames is used. This enables efficient reduction of data, and is therefore widely used.

IP Address

An address that is allocated to a network device. Each network device is given an address. Unlike MAC addresses, IP addresses change according to the installation environment.

MAC (Media Access Control) Address

A Mac address is a 48bit identification number assigned to a network device. It is assigned statically, not duplicated, and uses a unique number for each network device.

Multicast

A network communication format in which multiple network devices receive a single stream. By having multiple network devices receive the same image at the same quality, the network load of transmitting devices can be reduced, however, it is necessary to have devices and configurations that support multicast.

MJPEG (Motion JPEG)

This is a method for compressing images. It is used for remote transmission and recording of images. Due to compression and decompression being performed for each frame, subsequent frames are not impacted even when data are missing from some frames. Therefore, this method is sometimes used in environments with poor signal quality. However, a downside is that the data volume is larger than that for the H.264 format.

NTP (Network Time Protocol)

A protocol for synchronizing the time and the network server.

ONVIF (Open Network Video Interface Forum)

This is a standard that allows interconnection between network cameras and network recorder equipment from different manufacturers.

ping

A command used to check the connection status with other network devices. Generally, it is judged that there is a problem in the network route when there is no response to ping requests, and the ping command is used for finding out the cause of the problem.

PoE (Power over Ethernet)

A technology to supply electricity using an Ethernet cable.

Port

A communication contact number for network communication. When multiple services are provided by one network device, allotting an individual port number for each service allows the device to provide multiple services simultaneously.

Resolution

The LCD panel consists of numerous pixels of specified size, which are illuminated to form images. This monitor consists of 1920 horizontal pixels and 1080 vertical pixels. At a resolution of 1920 × 1080, all pixels are illuminated as a full screen (1:1).

Subnet Mask

A subnet mask is a numeric value where the network address part identifying the subnet can be specified in an IP address.

(Subnet: a divided network when controlling a large network by dividing into multiple networks)

TCP/IP (Transmission Control Protocol/Internet Protocol)

The TCP/IP is one of the network protocols for network communication. Using the TCP/IP protocols allows communication in various OSes.

traceroute

A command used to check the routes used to connect with other network devices.

Unicast

A network communication format in which individual network devices perform one-to-one communication. Whereas an image quality that is suitable for each individual network device can be transmitted, the downside to this format is that transmitting devices place a high load on the network.

Appendix

Trademark

The terms HDMI and HDMI High-Definition Multimedia Interface, and the HDMI Logo are trademarks or registered trademarks of HDMI Licensing, LLC in the United States and other countries.

The DisplayPort Compliance Logo and VESA are registered trademarks of the Video Electronics Standards Association.

The SuperSpeed USB Trident Logo is a registered trademark of USB Implementers Forum, Inc.



DICOM is the registered trademark of the National Electrical Manufacturers Association for its standards publications relating to digital communications of medical information.

Kensington and Microsaver are registered trademarks of ACCO Brands Corporation.

Thunderbolt is a trademark of Intel Corporation in the United States and/or other countries.

Microsoft and Windows are registered trademarks of Microsoft Corporation in the United States and other countries.

Adobe is a registered trademark of Adobe Systems Incorporated in the United States and other countries.

Apple, macOS, Mac OS, OS X, Macintosh and ColorSync are registered trademarks of Apple Inc.

ONVIF is a trademark of ONVIF Inc.

i-pro is registered trademark of Panasonic Corporation.

AXIS is a registered trademark of Axis AB in Sweden and other countries.

Ethernet is a registered trademark of Fuji Xerox Co., Ltd.

EIZO, the EIZO Logo, ColorEdge, CuratOR, DuraVision, FlexScan, FORIS, RadiCS, RadiForce, RadiNET, Raptor and ScreenManager are registered trademarks of EIZO Corporation in Japan and other countries.

ColorEdge Tablet Controller, ColorNavigator, EcoView NET, EIZO EasyPIX, EIZO Monitor Configurator, EIZO ScreenSlicer, G-Ignition, i•Sound, Quick Color Match, RadiLight, Re/Vue, Screen Administrator, Screen InStyle and UniColor Pro are trademarks of EIZO Corporation.

All other company and product names are trademarks or registered trademarks of their respective owners.

License

The bitmap font used for this product is designed by Ricoh Industrial Solutions Inc.

This product includes open source software.

If the open source software contains a product for which usage is granted under a GPL (GNU GENERAL PUBLIC LICENSE) license, Eizo Corporation will, in line with the GPL usage license conditions, provide the source code for corresponding GPL software via a medium, such as CD-ROM, at a cost to individuals and organizations who make contact via the following contact information for a minimum period of three years after purchase of the product.

We will also provide the source code for corresponding LGPL (GNU LESSER GENERAL PUBLIC LICENSE) software of products that include LGPL software licensed under the LGPL in the same manner as stated above.

Contact information

<http://www.eizoglobal.com/contact/index.html>

*Contact your local EIZO representative.

Except for open source software licensed under GPL, LPGL or other licenses, any transferring, copying, reverse assembly, reverse compiling or reverse engineering of any software included with this product is strictly prohibited. Further, exporting of any software included with this product in violation of applicable export laws is strictly prohibited.

This product is equipped with a built-in SD card slot. However, this SD card slot is for maintenance use only.



LIMITED WARRANTY

EIZO Corporation (hereinafter referred to as "EIZO") and distributors authorized by EIZO (hereinafter referred to as the "Distributors") warrant, subject to and in accordance with the terms of this limited warranty (hereinafter referred to as the "Warranty"), to the original purchaser (hereinafter referred to as the "Original Purchaser") who purchased the product specified in this document (hereinafter referred to as the "Product") from EIZO or Distributors, that EIZO and Distributors shall, at their sole discretion, either repair or replace the Product at no charge if the Original Purchaser becomes aware within the Warranty Period (defined below) that the Product malfunctions or is damaged in the course of normal use of the Product in accordance with the description in the instruction manual attached to the Product (hereinafter referred to as the "User's Manual").

The period of this Warranty is two (2) years from the date of purchase of the Product (hereinafter referred to as the "Warranty Period"). EIZO and Distributors shall bear no liability or obligation with regard to the Product in relation to the Original Purchaser or any third parties other than as provided under this Warranty.

EIZO and Distributors will cease to hold or store any parts (excluding design parts) of the Product upon expiration of seven (7) years after the production of the Product is discontinued. In repairing the monitor, EIZO and Distributors will use renewal parts which comply with our QC standards. If the unit cannot be repaired due to its condition or the stockout of a relevant part, EIZO and Distributors may offer the replacement by a product with equivalent performance instead of repairing it.

The Warranty is valid only in the countries or territories where the Distributors are located. The Warranty does not restrict any legal rights of the Original Purchaser.

Notwithstanding any other provision of this Warranty, EIZO and Distributors shall have no obligation under this Warranty whatsoever in any of the cases as set forth below:

- (a) Any defect of the Product caused by freight damage, modification, alteration, abuse, misuse, accident, incorrect installation, disaster, faulty maintenance and/or improper repair by third party other than EIZO and Distributors;
- (b) Any incompatibility of the Product due to possible technical innovations and/or regulations;
- (c) Any deterioration of the sensor;
- (d) Any defect of the Product caused by external equipment;
- (e) Any defect of the Product on which the original serial number has been altered or removed;
- (f) Any normal deterioration of the product, particularly that of consumables, accessories, and/or attachments (e.g. buttons, rotating parts, cables, User's Manual, etc.);
- (g) Any deformation, discoloration, and/or warp of the exterior of the product including that of the surface of the LCD panel;
- (h) Any defect of the Product caused by placement in a location where it may be affected by strong vibration or shocks;
- (i) Any defect of the Product caused by liquid leaking from battery; and
- (j) Any deterioration of display performance caused by the deterioration of expendable parts such as the LCD panel and/or backlight, etc. (e.g. changes in brightness, changes in brightness uniformity, changes in color, changes in color uniformity, defects in pixels including burnt pixels, etc.).

To obtain service under the Warranty, the Original Purchaser must deliver the Product, freight prepaid, in its original package or other adequate package affording an equal degree of protection, assuming the risk of damage and/or loss in transit, to the local Distributor. The Original Purchaser must present proof of purchase of the Product and the date of such purchase when requesting services under the Warranty.

The Warranty Period for any replaced and/or repaired product under this Warranty shall expire at the end of the original Warranty Period.

EIZO OR DISTRIBUTORS ARE NOT RESPONSIBLE FOR ANY DAMAGE TO, OR LOSS OF, DATA OR OTHER INFORMATION STORED IN ANY MEDIA OR ANY PART OF ANY PRODUCT RETURNED TO EIZO OR DISTRIBUTORS FOR REPAIR.

EIZO AND DISTRIBUTORS MAKE NO FURTHER WARRANTIES, EXPRESSED OR IMPLIED, WITH RESPECT TO THE PRODUCT AND ITS QUALITY, PERFORMANCE, MERCHANTABILITY OR FITNESS FOR ANY PARTICULAR USE. IN NO EVENT SHALL EIZO OR DISTRIBUTORS BE LIABLE FOR ANY INCIDENTAL, INDIRECT, SPECIAL, CONSEQUENTIAL OR OTHER DAMAGE WHATSOEVER (INCLUDING, WITHOUT LIMITATION, DAMAGES FOR LOSS OF PROFIT, BUSINESS INTERRUPTION, LOSS OF BUSINESS INFORMATION, OR ANY OTHER PECUNIARY LOSS) ARISING OUT OF THE USE OR INABILITY TO USE THE PRODUCT OR IN ANY CONNECTION WITH THE PRODUCT, WHETHER BASED ON CONTRACT, TORT, NEGLIGENCE, STRICT LIABILITY OR OTHERWISE, EVEN IF EIZO OR DISTRIBUTORS HAVE BEEN ADVISED OF THE POSSIBILITY OF SUCH DAMAGES. THIS EXCLUSION ALSO INCLUDES ANY LIABILITY WHICH MAY ARISE OUT OF THIRD PARTY CLAIMS AGAINST THE ORIGINAL PURCHASER. THE ESSENCE OF THIS PROVISION IS TO LIMIT THE POTENTIAL LIABILITY OF EIZO AND DISTRIBUTORS ARISING OUT OF THIS LIMITED WARRANTY AND/OR SALES.

Recycling Information

Recycling Information

This product, when disposed of, is supposed to be collected and recycled according to your country's legislation to reduce environmental burden. When you dispose of this product, please contact a distributor or an affiliate in your country.

The contact addressees are listed on the EIZO website below.

<http://www.eizoglobal.com>

For recycling information for customers in Switzerland, please refer to the following website.

<http://www.swico.ch>

Informationen zum Thema Recycling

Dieses Produkt muss gemäß den Vorschriften Ihres Landes zur Entlastung der Umwelt recyclet werden. Wenden Sie sich bei der Entsorgung dieses Produkts an einen Verteiler oder eine Tochtergesellschaft in Ihrem Land.

Die Adressen zur Kontaktaufnahme sind auf der unten angegebenen Website von EIZO aufgeführt.

<http://www.eizoglobal.com>

Kunden in der Schweiz entnehmen Informationen zum Recycling der folgenden Website:

<http://www.swico.ch>

Informations sur le recyclage

Ce produit doit être jeté aux points de collecte prévus à cet effet et recyclé conformément à la législation de votre pays, afin de réduire l'impact sur l'environnement. Lorsque vous jetez ce produit, veuillez contacter un distributeur ou une société affiliée de votre pays.

Les adresses des distributeurs sont répertoriées sur le site Web EIZO ci-dessous.

<http://www.eizoglobal.com>

Pour les clients en Suisse, veuillez consulter le site Web suivant afin d'obtenir des informations sur le recyclage.

<http://www.swico.ch>

Información sobre reciclaje

Este producto debe desecharse y reciclarse según la legislación del país para reducir el impacto medioambiental. Cuando desee deshacerse de este producto, póngase en contacto con un distribuidor o una filial de su país.

Encontrará las direcciones de contacto en el sitio web de EIZO que se indica a continuación.

<http://www.eizoglobal.com>

Informazioni sul riciclaggio

Per lo smaltimento e il riciclaggio del presente prodotto, attenersi alle normative vigenti nel proprio paese per ridurre l'impatto ambientale. Per lo smaltimento, rivolgersi ad un distributore o un affiliato presenti nel proprio paese.

Gli indirizzi sono elencati nel sito Web EIZO riportato di seguito.

<http://www.eizoglobal.com>

Per informazioni sul riciclaggio per i clienti in Svizzera, consultare il sito Web riportato di seguito.

<http://www.swico.ch>

Πληροφορίες ανακύκλωσης

Το προϊόν αυτό, όταν απορρίπτεται, πρέπει να συλλέγεται και να ανακυκλώνεται σύμφωνα με τη νομοθεσία της χώρας σας έτσι ώστε να μην επιβαρύνει το περιβάλλον. Για να απορρίψετε το προϊόν, επικοινωνήστε με έναν αντιπρόσωπο ή μια θυγατρική εταιρεία στη χώρα σας.

Οι διευθύνσεις επικοινωνίας αναγράφονται στην τοποθεσία web της EIZO παρακάτω.
<http://www.eizoglobal.com>

Сведения по утилизации

По истечении срока службы данного продукта его следует принести на сборный пункт и утилизировать в соответствии с действующими предписаниями в вашей стране, чтобы уменьшить вредное воздействие на окружающую среду. Прежде чем выбросить данный продукт, обратитесь к дистрибьютору или в местное представительство компании в вашей стране.

Контактные адреса можно найти на веб-узле EIZO.

<http://www.eizoglobal.com>

Informatie over recycling

Wanneer u dit product wilt weggooien, moet het uit milieu-overwegingen worden verzameld en gerecycled volgens de betreffende wetgeving van uw land. Wanneer u dit product wilt weggooien, moet u contact opnemen met een distributeur of een partner in uw land.

De contactadressen worden vermeld op de volgende EIZO-website.

<http://www.eizoglobal.com>

Informação sobre reciclagem

Este produto, quando o deitar fora, deve ser recolhido e reciclado de acordo com a legislação do seu país para reduzir a poluição. Quando deitar fora este produto, contacte um distribuidor ou uma filial no seu país.

Os endereços de contacto estão listados no website do EIZO, abaixo.

<http://www.eizoglobal.com>

Oplysninger om genbrug

Denne produkt forventes ved bortskaffelse at blive indsamlet og genbrugt i overensstemmelse med lovgivningen i dit land for at reducere belastningen af miljøet. Når du bortskaffer denne produkt, skal du kontakte en distributør eller et tilknyttet selskab i dit land.

Adresserne på kontaktpersonerne er angivet på EIZO's websted nedenfor.

<http://www.eizoglobal.com>

Kierrätystä koskevia tietoja

Tuote tulee hävittää kierrättämällä maan lainsäädännön mukaisesti ympäristön kuormittumisen vähentämiseksi. Kun hävität tuotteen, ota yhteyttä jälleenmyyjään tai tytäryhtiöön maassasi.

Yhteystiedot löytyvät EIZOn Internet-sivustolta.

<http://www.eizoglobal.com>

Wykorzystanie surowców wtórnych

Ten produkt po zużyciu powinien być zbierany i przetwarzany zgodnie z krajowymi przepisami dotyczącymi ochrony środowiska. Wyrzucając ten produkt, należy skontaktować się z lokalnym dystrybutorem lub partnerem. Adresy kontaktowe można znaleźć we wskazanej poniżej witrynie internetowej firmy EIZO.

<http://www.eizoglobal.com>

Informace o recyklaci

Při likvidaci produktu musí být produkt vyzvednut a recyklován podle zákonů příslušné země, aby nedocházelo k zatěžování životního prostředí. Zbavujete-li se produktu, kontaktujte distributora nebo pobočku ve své zemi. Kontaktní adresy jsou uvedeny na následující webové stránce společnosti EIZO.
<http://www.eizoglobal.com>

Ringlussevõtu alane teave

Keskkonnakoormuse vähendamiseks tuleks kasutatud tooted kokku koguda ja võtta ringlusse vastavalt teie riigi seadustele. Kui kõrvaldate käesoleva toote, võtke palun ühendust turustaja või filiaaliga oma riigis. Kontaktisikud on toodud EIZO veebilehel järgmisel aadressil:
<http://www.eizoglobal.com>

Újrahasznosítási információ

Jelen terméket, amikor eldobjuk, az illető ország törvényei alapján kell összegyűjteni és újrahasznosítani, hogy csökkentsük a környezet terhelését. Amikor ezt a terméket eldobja, kérjük lépjen kapcsolatba egy országon belüli forgalmazóval vagy társvállalkozással.
A kapcsolat címei az EIZO alábbi weboldalán találhatók felsorolva:
<http://www.eizoglobal.com>

Podatki o recikliranju

Ob koncu uporabe odslužen izdelek izročite na zbirno mesto za recikliranje v skladu z okoljevarstveno zakonodajo vaše države. Prosimo, da se pri odstranjevanju izdelka obrnete na lokalnega distributerja ali podružnico.
Kontaktne naslovi so objavljeni na spodaj navedenih spletnih straneh EIZO:
<http://www.eizoglobal.com>

Informácie o recyklácii

Pri likvidácii musí byť tento výrobok recyklovaný v súlade s legislatívou vašej krajiny, aby sa znížilo zaťaženie životného prostredia. Keď sa chcete zbaviť tohto výrobku, kontaktujte prosím distribútora alebo pobočku vo vašej krajine.
Zoznam kontaktných adries je uvedený na nasledovnej webovej stránke firmy EIZO:
<http://www.eizoglobal.com>

Pārstrādes informācija

Utilizējot šo produktu, tā savākšana un pārstrāde veicama atbilstoši jūsu valsts likumdošanas prasībām attiecībā uz slodzes uz vidi samazināšanu. Lai veiktu šī produkta utilizāciju, sazinieties ar izplatītāju vai pārstāvniecību jūsu valstī.
Kontaktadrese ir norādītas zemāk minētajā EIZO tīmekļa vietnē.
<http://www.eizoglobal.com>

Informacja apie gražinamąjį perdirbimą

Šalinant (išmetant) šiuos gaminius juos reikia surinkti ir perdirbti gražinamuju būdu pagal jūsų šalies teisės aktus, siekiant sumažinti aplinkos teršimą. Kai reikia išmesti šį gaminį, kreipkitės į jūsų šalyje veikiančią gaminių pardavimo atstovybę arba jos filiaalą.
Kontaktiniai adresatai nurodyti EIZO interneto svetainėje.
<http://www.eizoglobal.com>

