

FDS1904/FDS1904T

Revised

B : Add the housing tolerance for mounting

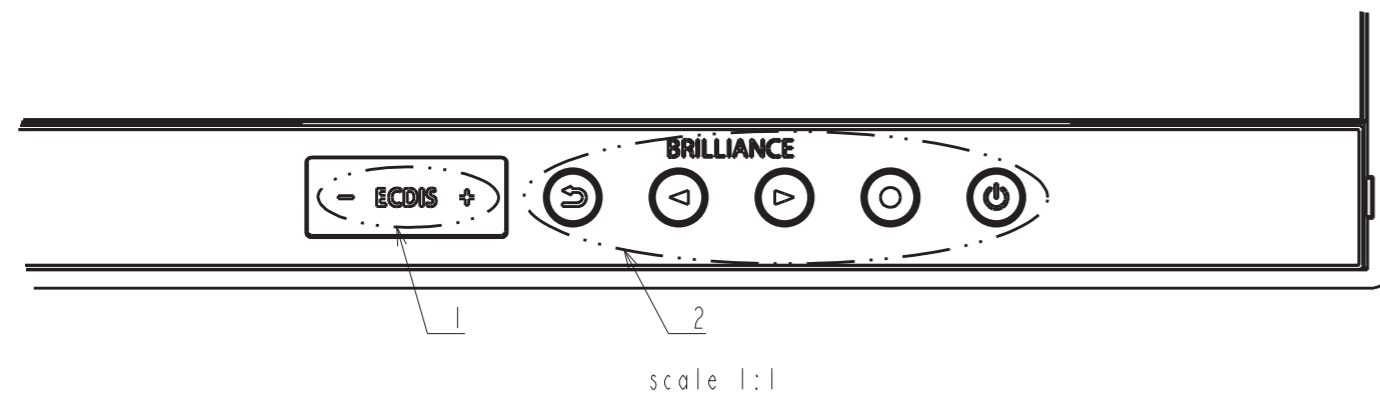
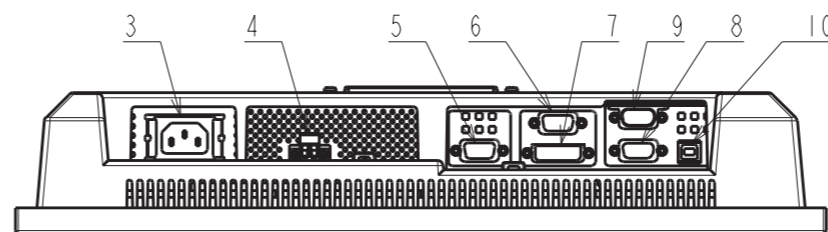
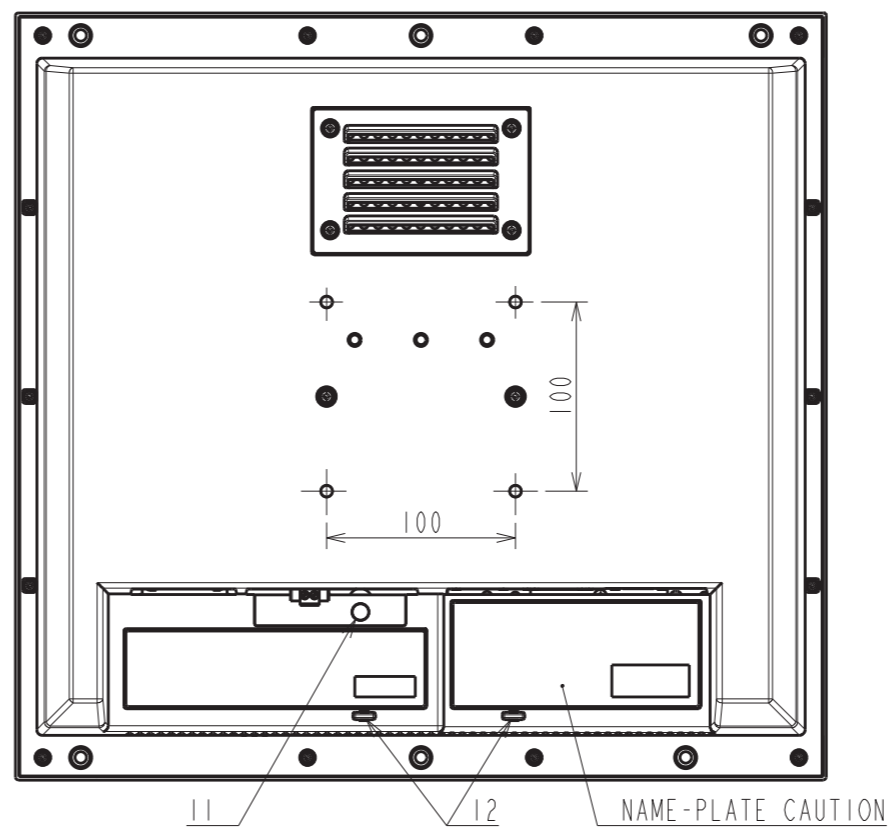
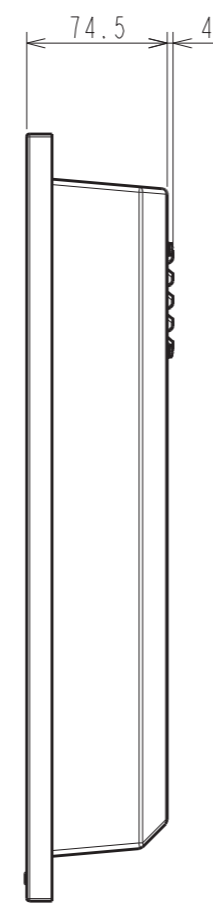
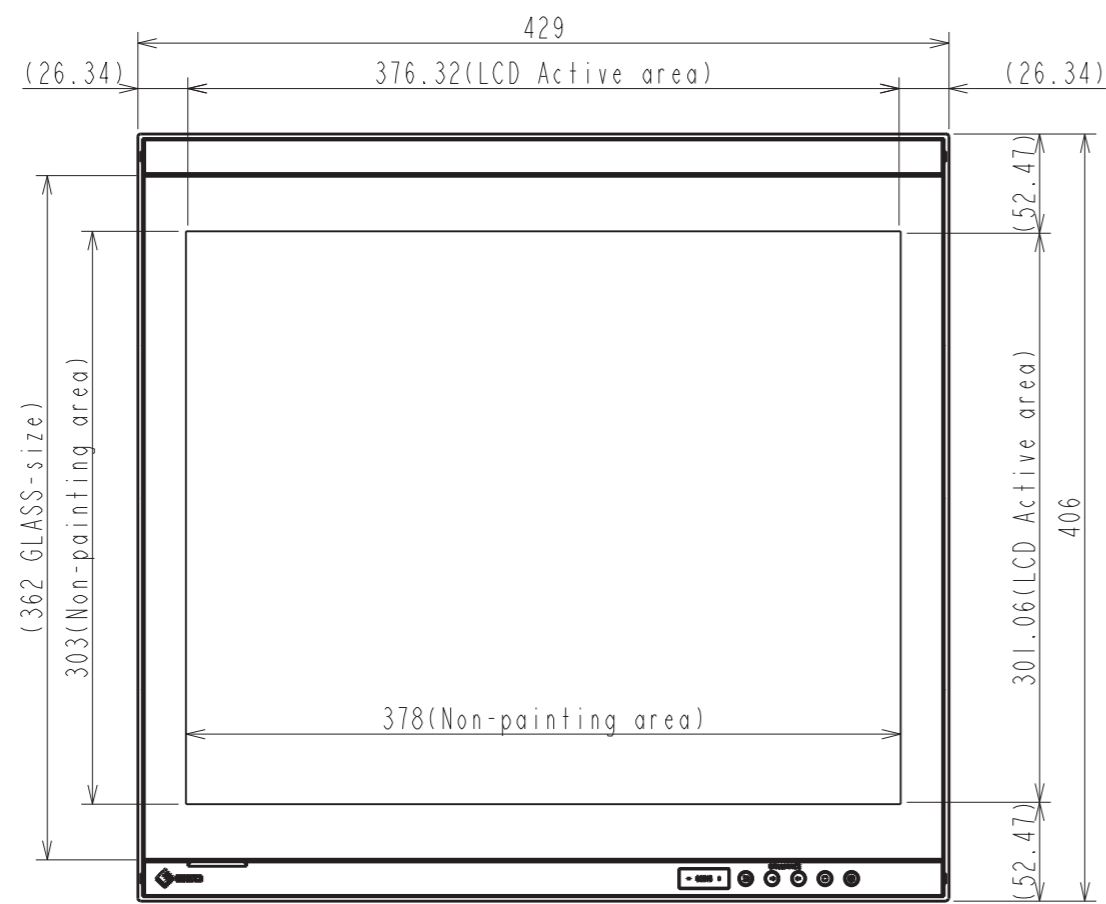
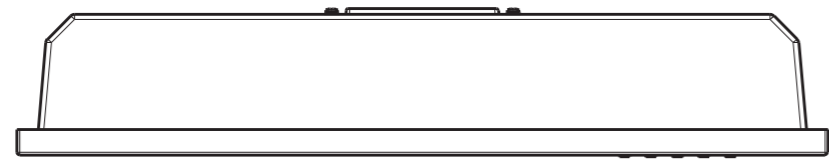

scale 1:1

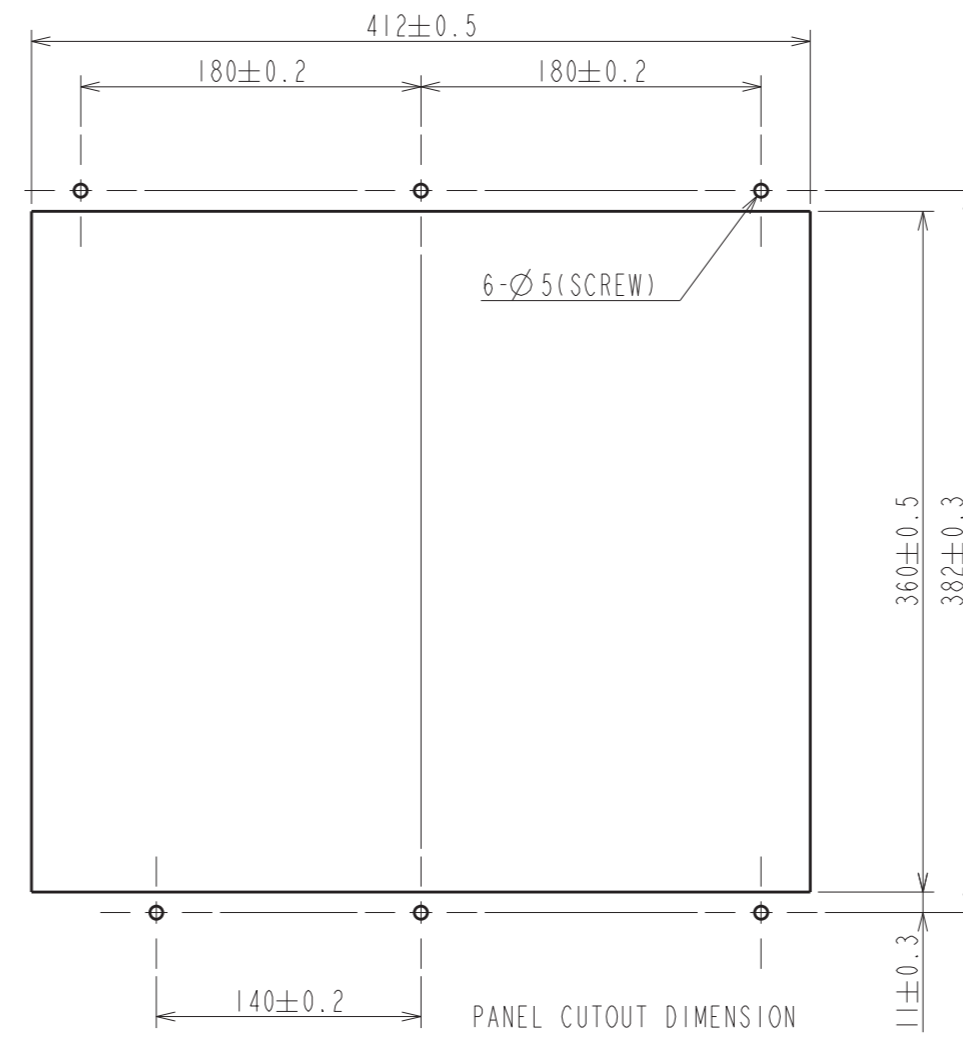

●Housing tolerance for the mounting

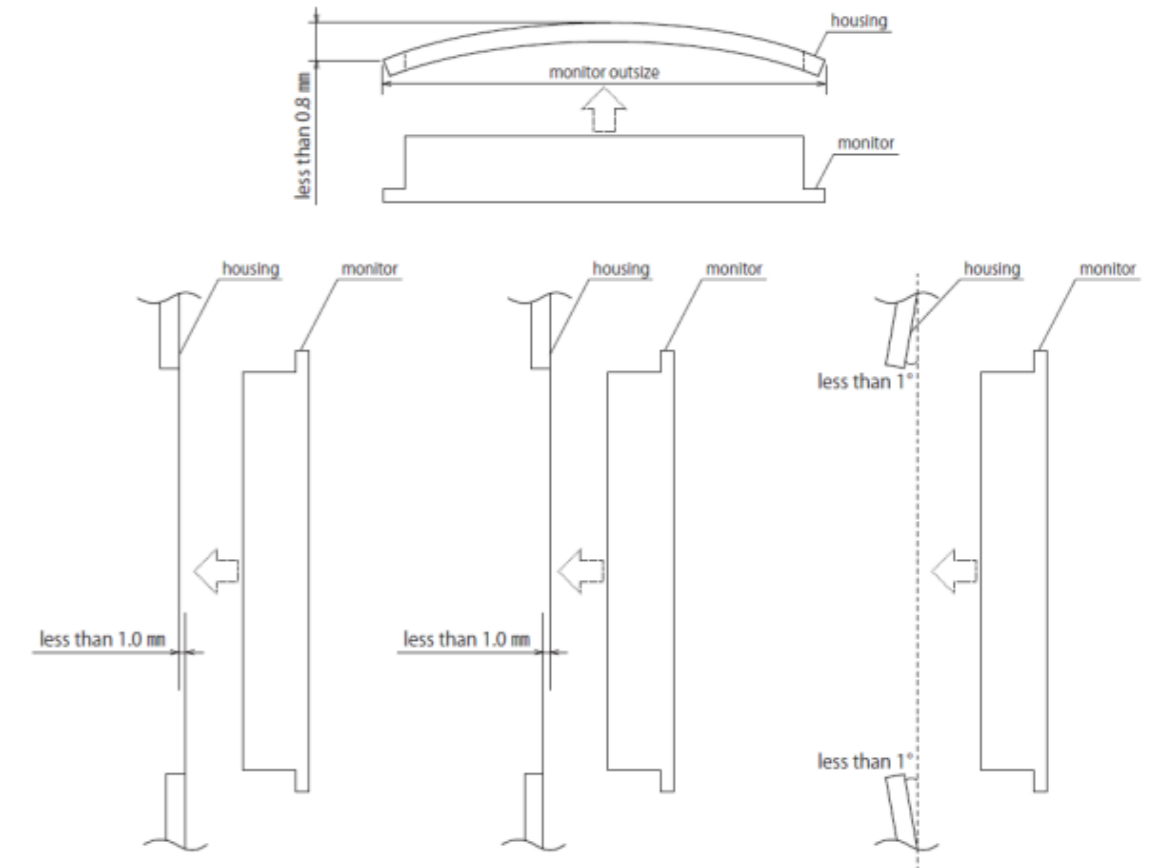

1. ECDIS INDICATOR
2. BUTTON
BACK RETURN / LEFT ARROW /
RIGHT ARROW / RETURN / POWER
3. POWER INPUT_(AC)
4. POWER INPUT_(DC)
5. OUTPUT SIGNAL CONNECTOR
6. INPUT SIGNAL CONNECTOR_(D-SUB15P)
7. INPUT SIGNAL CONNECTOR_(DVI-D)
8. MONITOR CONTROL PORT_(D-SUB9P)
9. SERIAL PORT_(FDS1904T only)
10. USB PORT_(FDS1904T only)
11. FUNCTION EARTH TERMINAL
12. CABLE HOLDER

[mm]