

# OUTLINE DIMENSIONS

MODEL EV2430

UNIT mm

**EIZO Corporation**

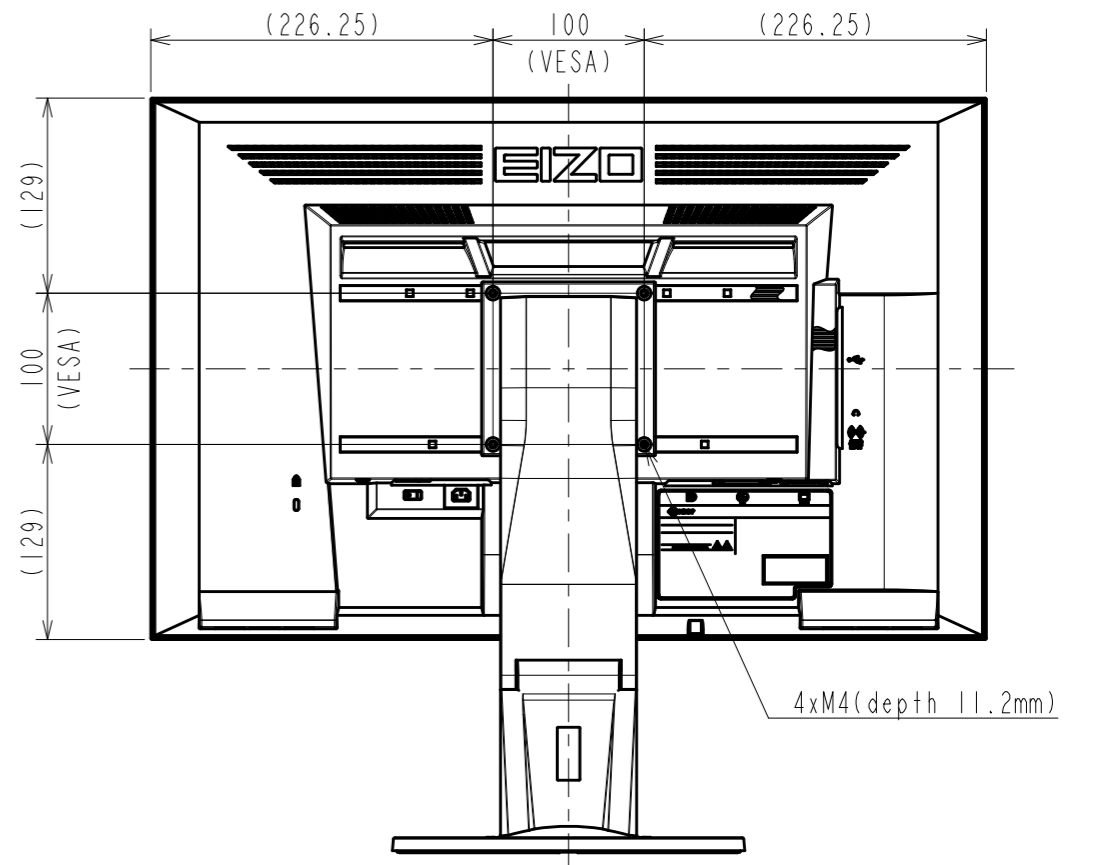
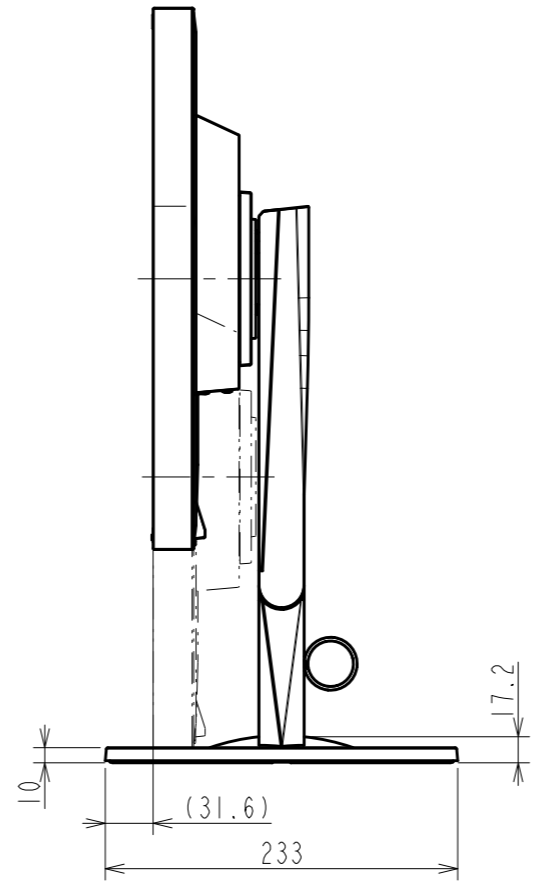
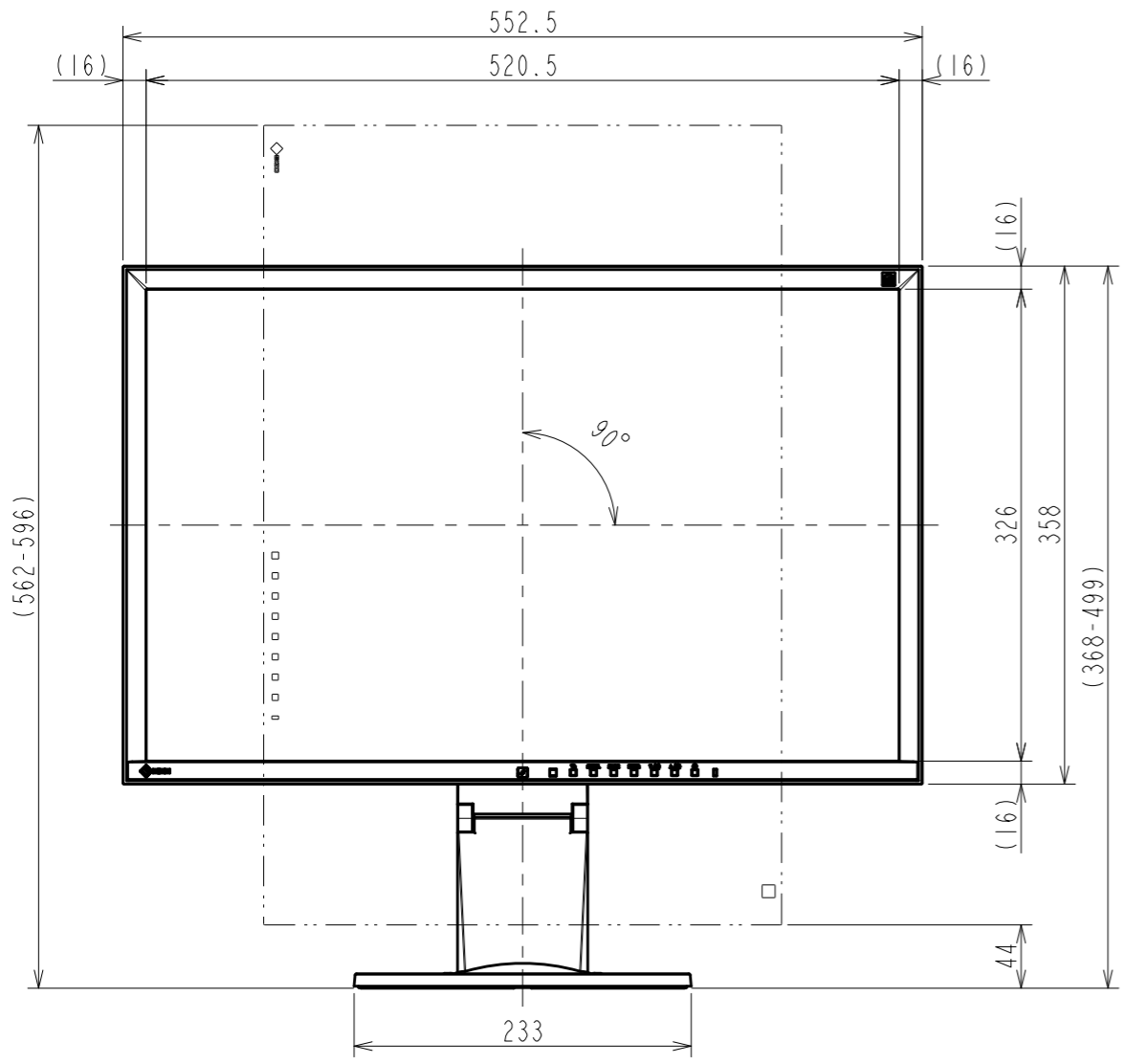
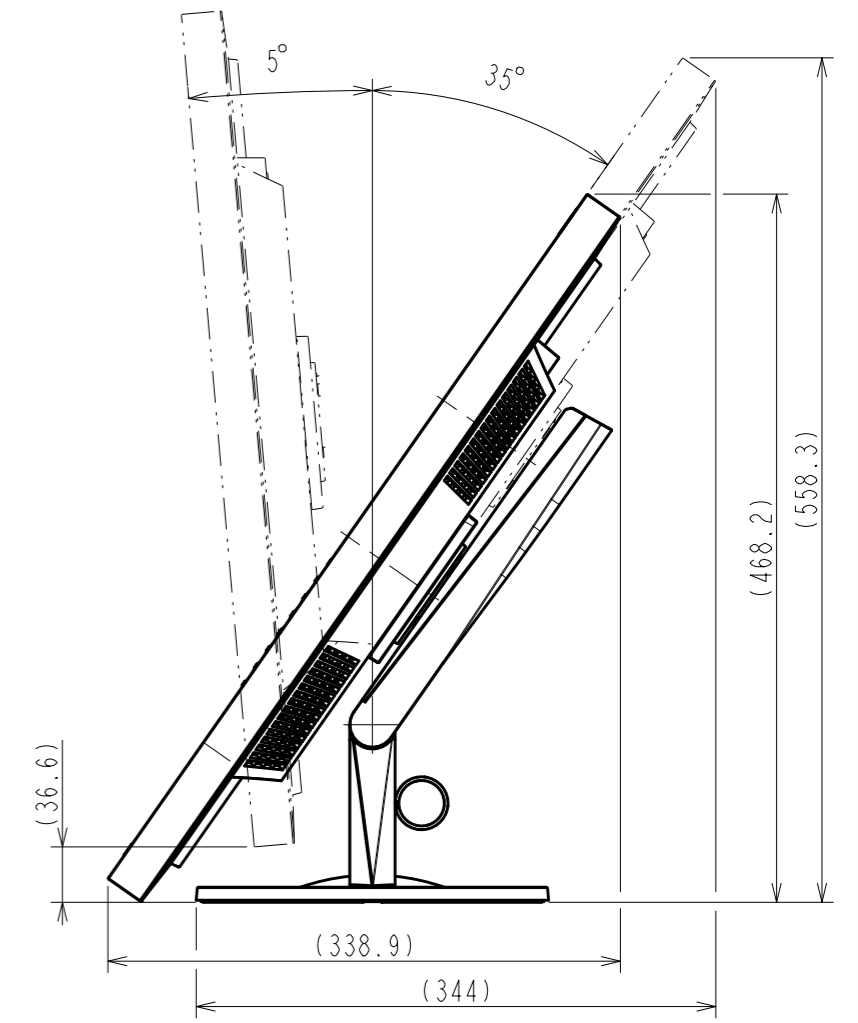
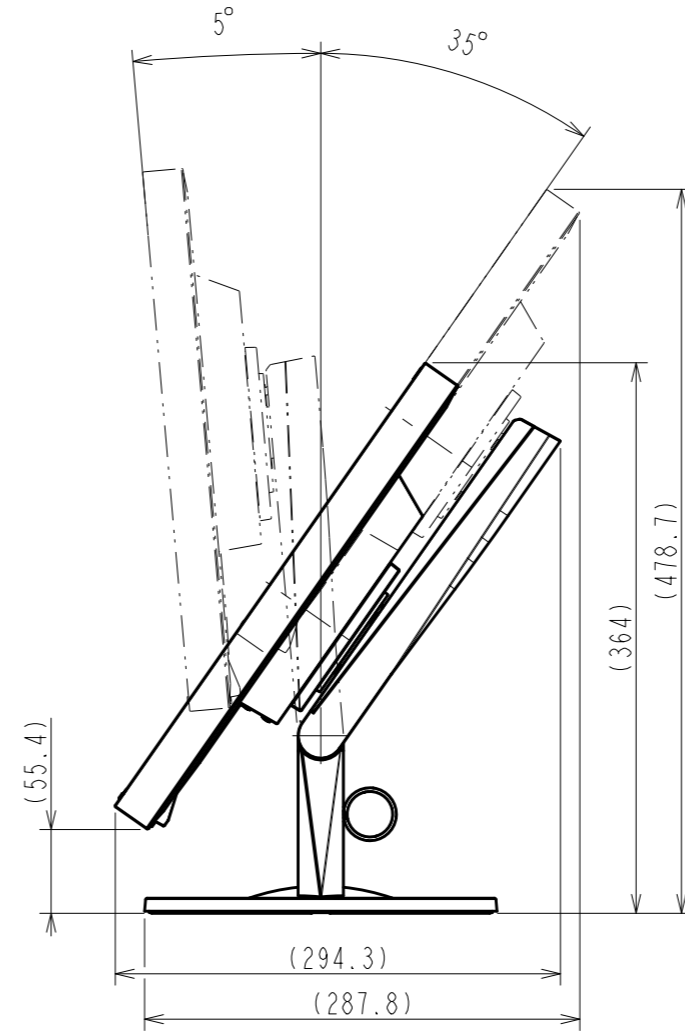
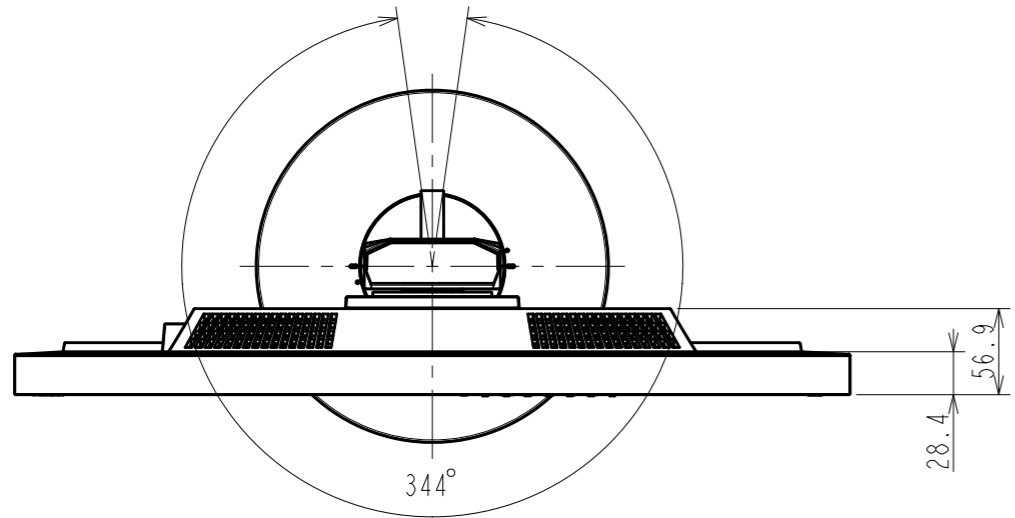

# OUTLINE DIMENSIONS

MODEL EV2430

UNIT mm

**EIZO Corporation**

