

# OUTLINE DIMENSIONS

MODEL EV3285

UNIT mm

**EIZO Corporation**

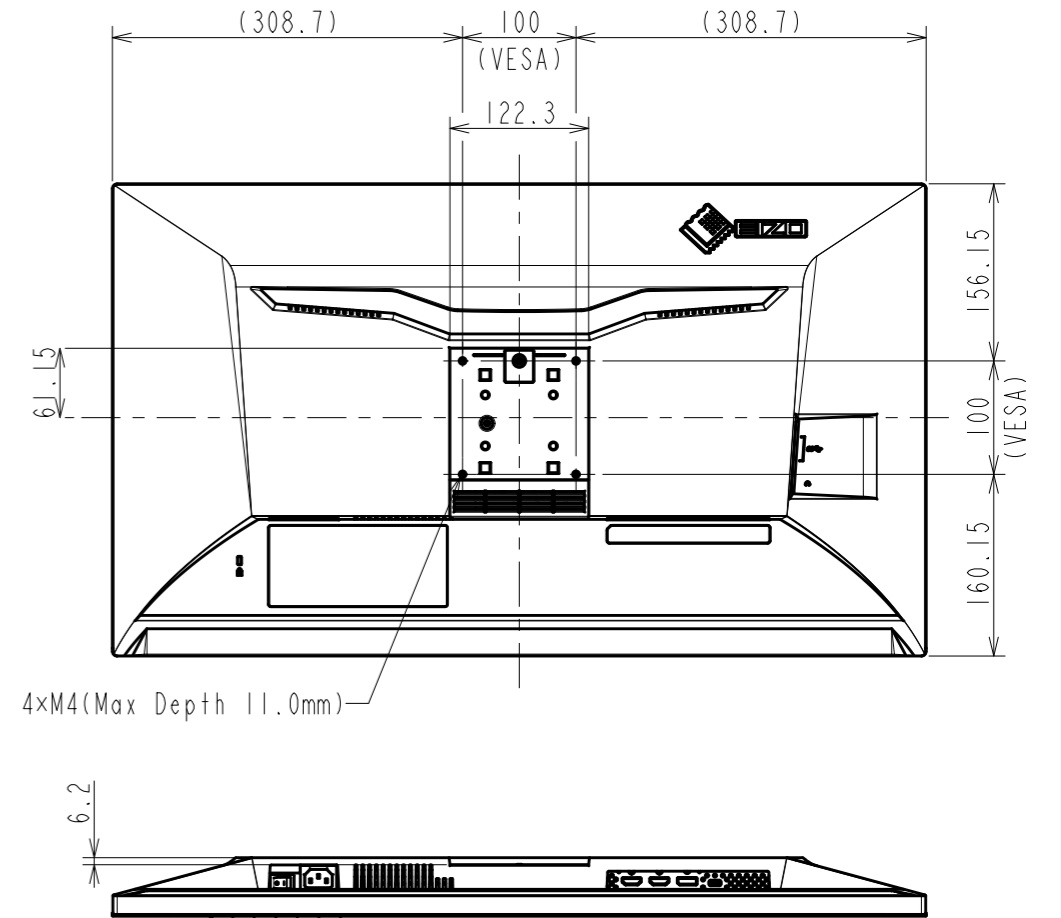
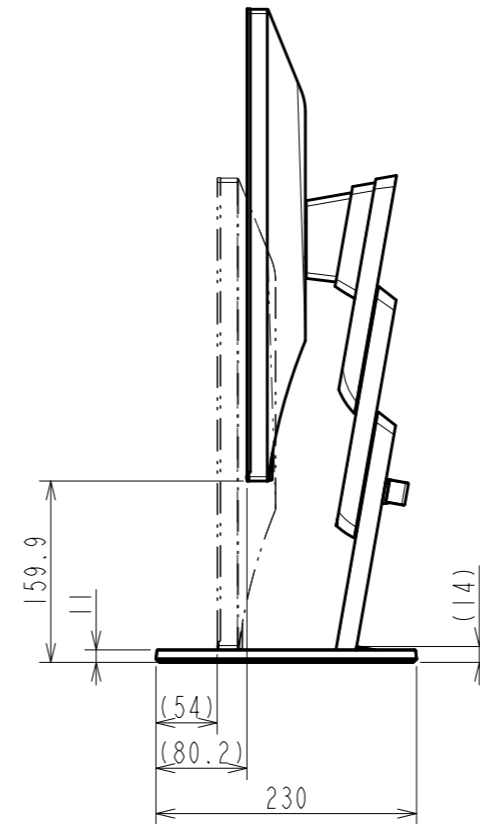
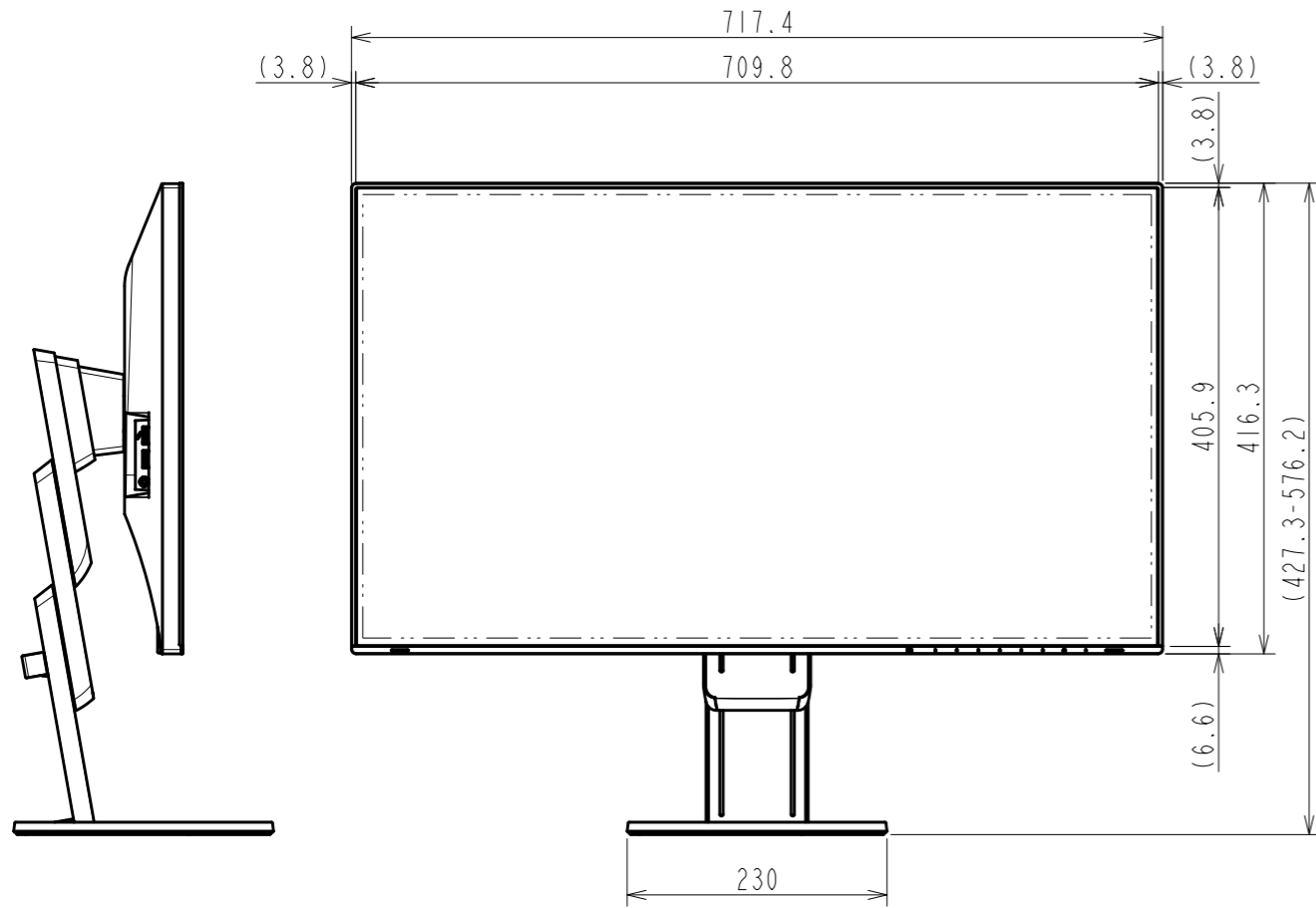
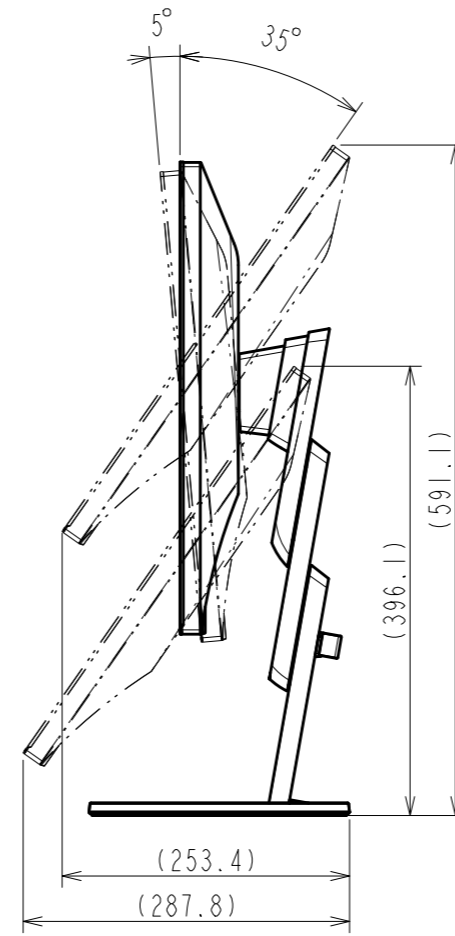
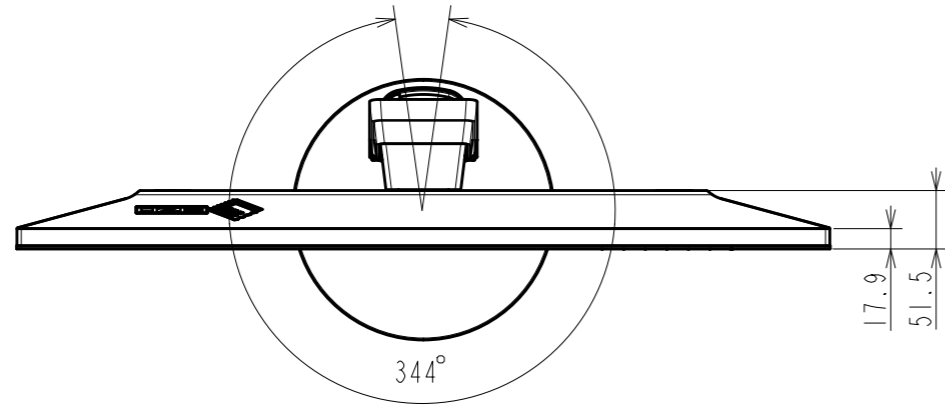

# OUTLINE DIMENSIONS

MODEL EV3285

UNIT mm

**EIZO Corporation**

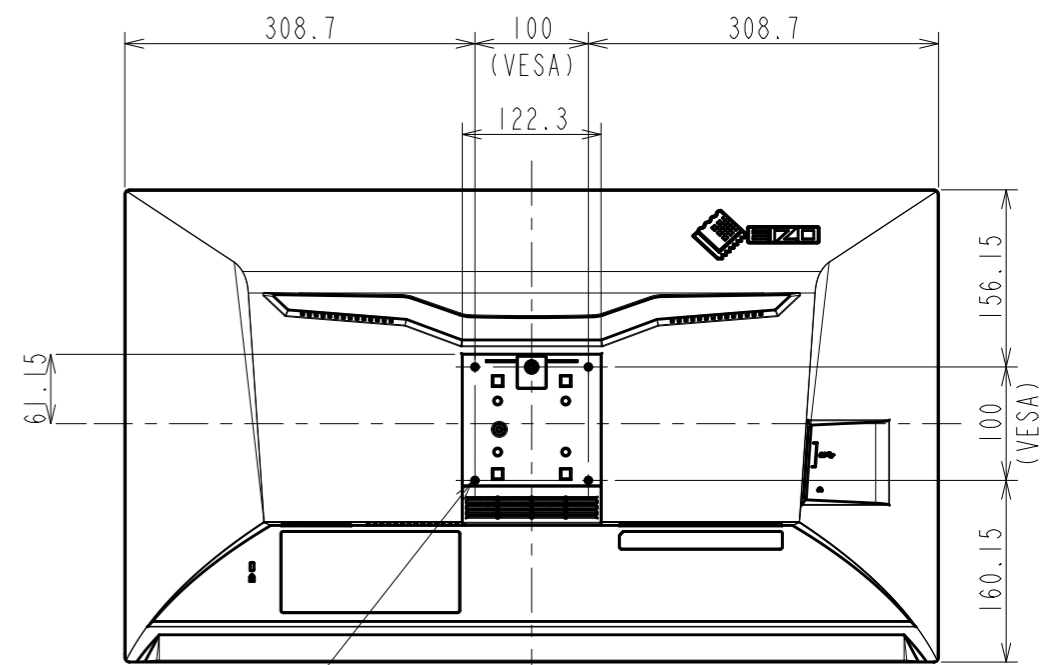
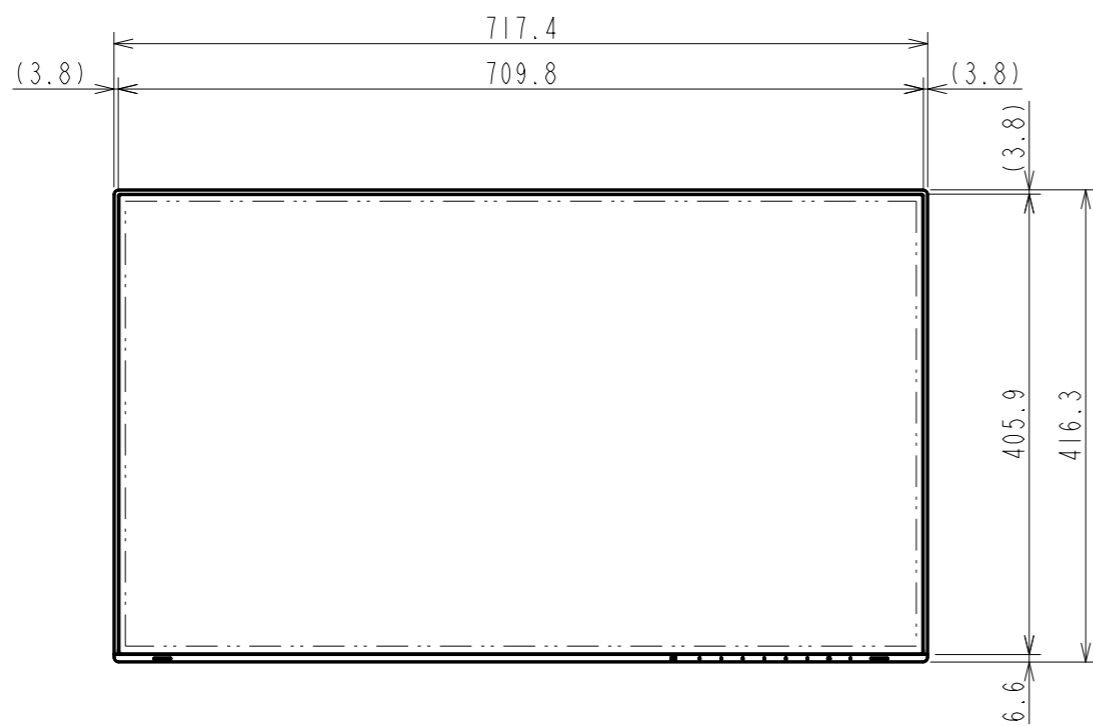
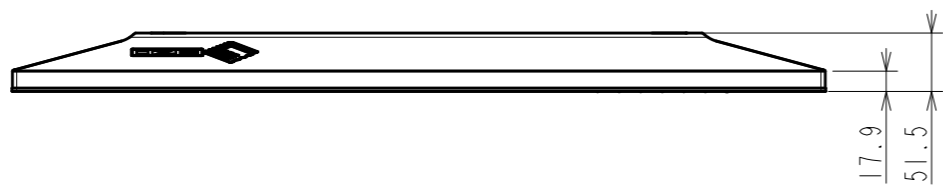

4xM4(Max Depth 11.0mm)

