

Instructions for Use

UX2 Sensor

Calibration Sensor



Important

Please read this “Instructions for Use” carefully to familiarize yourself with safe and effective usage.

Please retain this manual for future reference.

SAFETY SYMBOLS

This manual and this product use the safety symbols below. They denote critical information. Please read them carefully.

	WARNING Failure to abide by the information in a WARNING may result in serious injury and can be life threatening.
	Indicates a prohibited action.
	Indicates a mandatory action.

Symbols on the unit

	Direct current
---	----------------

No part of this manual may be reproduced, stored in a retrieval system, or transmitted, in any form or by any means, electronic, mechanical, or otherwise, without the prior written permission of EIZO Corporation.

EIZO Corporation is under no obligation to hold any submitted material or information confidential unless prior arrangements are made pursuant to EIZO Corporation's receipt of said information. Although every effort has been made to ensure that this manual provides up-to-date information, please note that EIZO monitor specifications are subject to change without notice.

EIZO, the EIZO Logo and RadiCS are registered trademarks of EIZO Corporation in Japan and other countries. All other company and product names are trademarks or registered trademarks of their respective owners.

PRECAUTIONS

WARNING

If an abnormal phenomenon, such as smoke, strange noise(s), or odor(s), is detected, immediately disconnect the product from the monitor or computer, and contact your EIZO representative.

Attempting to use a malfunctioning unit may result in fire, electric shock, or equipment damage.

Do not open the cabinet or modify the unit.

Opening the cabinet or modifying the unit may result in fire, electric shock, or burn.



Refer all servicing to qualified service personnel.

Do not attempt to service this product yourself as opening or removing covers may result in fire, electric shock, or equipment damage.

Do not use the product near equipment that is vulnerable to magnetic fields.

Magnets are used in this product. If the product is used near the equipment shown below, normal operations may be interrupted or records may be damaged due to magnetic fields.

- Precision equipment
 - Magnetic storage media such as magnetic cards, prepaid cards, and tickets
 - Electronic or communication equipment such as speakers, CD or DVD players, and mobile phones
-

Dispose of the products in accordance with the laws and regulations of your region.

Introduction

This product is a sensor that is used to perform calibration, Luminance checks, Grayscale checks, and other operations using RadiCS monitor quality control software. For information on how to use RadiCS, refer to the RadiCS User's Manual.

Package Contents

Check that all the following items are contained in the package. If any items are missing, contact your EIZO representative.

- UX2 Sensor
(Including a magnet with a band and adsorptive sheet)
- Protective cap*1
- Storage case
- Adsorptive sheet for the replacement
- Cleaning cloth
- Instructions for Use (this book)
- "RadiCS" quality control software*2

*1 This product is attached to the UX2 Sensor at the time of shipment.

*2 Only available when you purchase RadiCS UX2.

Compatible Monitors

This product is provided specifically for the EIZO RadiForce series monitor. Usage with a monitor that is not compatible may not be covered by the warranty.

For details on the compatible monitors, refer to our web site. <http://www.eizoglobal.com/>

Precautions for Use

- Measurement accuracy may be compromised if the product is subjected to excessive impact, such as by being dropped, etc.
If the product has been subjected to a strong impact, we recommend that you carry out calibration.
- Measurement accuracy may be compromised if the product is stored or used in the following environments.
 - Location subject to direct sunshine
 - Location containing dust
 - Location in which corrosive gases (dioxide gas, hydrogen sulfide gas, nitrogen dioxide gas, chlorine, ammonia, ozone, etc.) do or may exist
 - Location in which substances (sodium chloride, sulfur, etc.) that cause corrosion exist in dust or air
- If you place this product in a room while the product is cold, or if you raise the room temperature abruptly, dew may form on the surface or inside the product (condensation). Should dew form, please wait until it has disappeared before connecting the product. If you use the product while dew is still on it, a malfunction may occur.

Attaching the Product

Attention

- To use the UX2 Sensor, you need to install RadiCS in advance. For details, refer to the RadiCS User's Manual.
- Wipe any dust, water droplets, dirt, etc. off the monitor screen before attaching the UX2 Sensor.
- If the adsorptive sheet is dusty or dirty, wipe it before attaching the UX2 Sensor.
- Do not forcibly press the UX2 Sensor against the monitor. Doing so may cause a display error such as interference patterns appearing on the monitor.

Connect the USB cable to the USB downstream port of the PC and the USB upstream port of the monitor.

1. Connect the USB connector of the UX2 Sensor to the USB downstream port of the PC or monitor.

When the PC recognizes the UX2 Sensor, the LED indicator of the UX2 Sensor lights up blue.

2. Turn the protective cap and remove it from the UX2 Sensor.

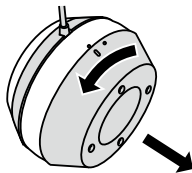

3. Attach the UX2 Sensor to the measurement position on the monitor screen. (Figure 1)
The adsorptive sheet has a cover film at the time of shipment. Before attaching the sheet, peel the film off. Align the four lines in front of the UX2 Sensor with the cross line displayed in the measurement area.
4. Carefully slide the magnet, and fix it to the stand attachment part of the monitor. (Figure 2)

Figure 1

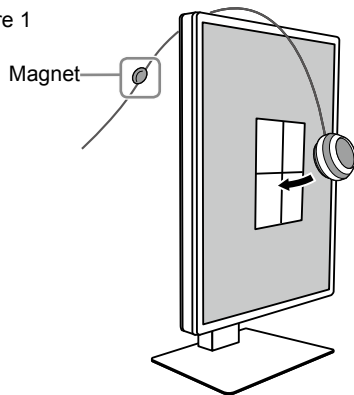
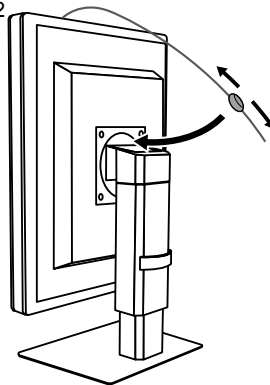

Figure 2



Note

- When you execute calibration or various tests of the monitor using the UX2 Sensor via RadiCS, the LED indicator is turned off.
-

Adsorptive Effect of Adsorptive Sheet

If the adsorptive effect of the adsorptive sheet becomes weak, slightly moisten the cleaning cloth contained in the package with water and wipe the adsorptive sheet.

If you continue to use the adsorptive sheet while the adsorptive effect is weak, the sensor section may fall off or measurement accuracy may be compromised.

Attention

- Make sure that the adsorptive sheet is dry before attaching it to the monitor screen.
 - Make sure that no water droplets splash onto the light receiving section. Otherwise, measurement results may be compromised.
-

Persistent Issue with Adsorptive Sheet

If the adsorptive effect of the adsorptive sheet remains weak, replace it with a spare one.

1. Peel off the adsorptive sheet attached to the UX2 Sensor.
2. Peel the seal off from the spare adsorptive sheet, and attach it to the UX2 Sensor.

Note

- The absorption pad can be purchased separately if necessary. Contact your EIZO representative.
-

Detaching the Product

1. Detach the UX2 Sensor from the monitor.
Carefully pull the UX2 Sensor off from the bottom.
2. Insert the protective cap into the dent of the UX2 Sensor, and turn the protective cap to fix it.

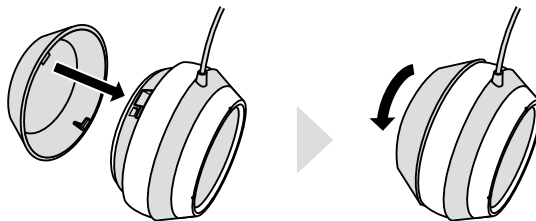

Attention

- To prevent the detector area from becoming dusty, store the product with the protective cap attached.
3. Disconnect the USB connector of the UX2 Sensor from the USB downstream port of the PC or monitor.
To store the product, we recommend that you bundle the cable using the band with the magnet and put it into the storage case. Exercise care not to bundle the cable too tightly.

Product Care

Cleaning

Attention

- Using chemicals such as alcohol or disinfectant may lead to defects such as discoloring or color fading.
- Never use thinner, benzene, wax, or polishing cleaner as these will damage the sensor section.

To wipe off dirt, use the cleaning cloth supplied with this product.

If you use the product while the detector area is dusty or dirty, measurement accuracy may be compromised. Wipe off dust or dirt thoroughly.

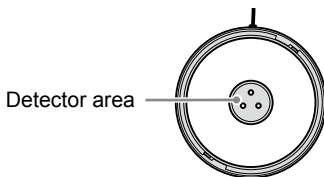

Maintenance

It is recommended that you calibrate the product annually in order to maintain measurement accuracy.

Specifications

Interface		USB
Voltage and current ratings		5.0 ± 0.25 V, 50 mA
Weight		Approx. 100 g (Including the protective cap and cable)
Dimensions		70.0 mm (Diameter) x 44.0 mm (Height) (Including protective cap)
Operating environment conditions	Temperature	16 °C - 30 °C
	Humidity	20 % - 70 % (R.H., no dew)
	Atmospheric pressure	700 hPa - 1060 hPa
Transportation and storage environment conditions	Temperature	-20 °C - 60 °C
	Humidity	10 % - 90 % (R.H., no dew)
	Atmospheric pressure	200 hPa - 1060 hPa

Attention

- To maintain measurement accuracy, we recommend that you store and use the product at a temperature of 30 °C or less and humidity of 70 % or less.

Outside Dimensions

Units: mm

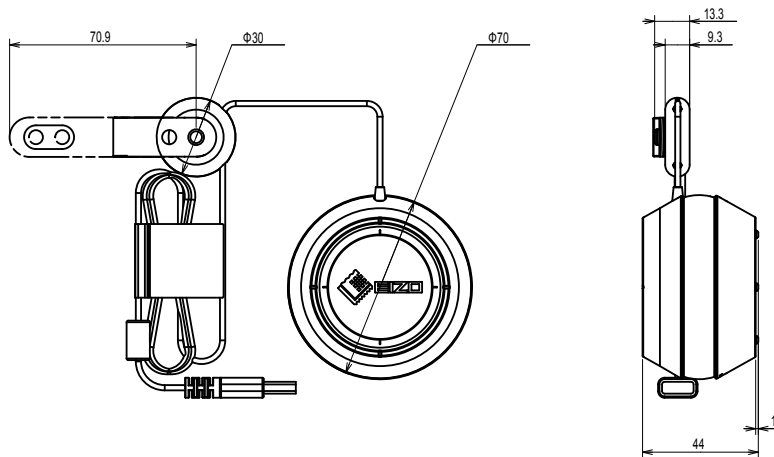

FCC Declaration of Conformity

We, the Responsible Party

EIZO Inc.

5710 Warland Drive, Cypress, CA 90630

Phone: (562) 431-5011

declare that the product

Trade name: EIZO

Model: UX2 Sensor

is in conformity with Part 15 of the FCC Rules. Operation of this product is subject to the following two conditions: (1) this device may not cause harmful interference, and (2) this device must accept any interference received, including interference that may cause undesired operation.

This equipment has been tested and found to comply with the limits for a Class B digital device, pursuant to Part 15 of the FCC Rules. These limits are designed to provide reasonable protection against harmful interference in a residential installation. This equipment generates, uses, and can radiate radio frequency energy and, if not installed and used in accordance with the instructions, may cause harmful interference to radio communications. However, there is no guarantee that interference will not occur in a particular installation. If this equipment does cause harmful interference to radio or television reception, which can be determined by turning the equipment off and on, the user is encouraged to try to correct the interference by one or more of the following measures.

- * Reorient or relocate the receiving antenna.
- * Increase the separation between the equipment and receiver.
- * Connect the equipment into an outlet on a circuit different from that to which the receiver is connected.
- * Consult the dealer or an experienced radio/TV technician for help.

Changes or modifications not expressly approved by the party responsible for compliance could void the user's authority to operate the equipment.

Canadian Notice

This Class B digital apparatus complies with Canadian ICES-003.

Cet appareil numérique de la classe B est conforme à la norme NMB-003 du Canada.

China RoHS

关于电器电子产品有害物质限制使用标识

本标识根据「电器电子产品有害物质限制使用管理办法」,适用于在中华人民共和国销售的电器电子产品。标识中央的数字为环保使用期限的年数。只要您遵守该产品相关的安全及使用注意事项,在自制造日起算的年限内,不会产生对环境污染或人体及财产的影响。上述标识粘贴在机器背面。

下表是依据SJ/T 11364-2014 的规定编制。



产品中有害物质的名称及含量

部件名称	有害物质					
	铅 (Pb)	汞 (Hg)	镉 (Cd)	六价铬 (Cr(VI))	多溴联苯 (PBB)	多溴二苯醚 (PBDE)
印刷电路板	×	○	○	○	○	○
机箱	○	○	○	○	○	○
其他	×	○	○	○	○	○

本表格依据SJ/T 11364 的规定编制。

- : 表示该有害物质在该部件所有均质材料中的含量均在GB/T 26572规定的限量要求以下。
- × : 表示该有害物质至少在该部件的某一均质材料中的含量超出GB/T 26572规定的限量要求。

Recycling Information

Recycling Information

This product, when disposed of, is supposed to be collected and recycled according to your country's legislation to reduce environmental burdens. When you dispose of this product, please contact a distributor or an affiliate in your country.

The contact addressees are listed on the EIZO website below.

<http://www.eizoglobal.com>

For recycling information for customers in Switzerland, please refer to the following website.

<http://www.swico.ch>

Informationen zum Thema Recycling

Dieses Produkt muss gemäß den Vorschriften Ihres Landes zur Entlastung der Umwelt recyclet werden. Wenden Sie sich bei der Entsorgung dieses Produkts an einen Verteiler oder eine Tochtergesellschaft in Ihrem Land.

Die Adressen zur Kontaktaufnahme sind auf der unten angegebenen Website von EIZO aufgeführt.

<http://www.eizoglobal.com>

Kunden in der Schweiz entnehmen Informationen zum Recycling der folgenden Website:

<http://www.swico.ch>

Informations sur le recyclage

Ce produit doit être jeté aux points de collecte prévus à cet effet et recyclé conformément à la législation de votre pays, afin de réduire l'impact sur l'environnement. Lorsque vous jetez ce produit, veuillez contacter un distributeur ou une société affiliée de votre pays.

Les adresses des distributeurs sont répertoriées sur le site Web EIZO ci-dessous.

<http://www.eizoglobal.com>

Pour les clients en Suisse, veuillez consulter le site Web suivant afin d'obtenir des informations sur le recyclage.

<http://www.swico.ch>

Información sobre reciclaje

Este producto debe desecharse y reciclarse según la legislación del país para reducir el impacto medioambiental. Cuando desee deshacerse de este producto, póngase en contacto con un distribuidor o una filial de su país. Encontrará las direcciones de contacto en el sitio web de EIZO que se indica a continuación.

<http://www.eizoglobal.com>

Informazioni sul riciclaggio

Per lo smaltimento e il riciclaggio del presente prodotto, attenersi alle normative vigenti nel proprio paese per ridurre l'impatto ambientale. Per lo smaltimento, rivolgersi ad un distributore o un affiliato presenti nel proprio paese. Gli indirizzi sono elencati nel sito Web EIZO riportato di seguito.

<http://www.eizoglobal.com>

Per informazioni sul riciclaggio per i clienti in Svizzera, consultare il sito Web riportato di seguito.

<http://www.swico.ch>

Återvinningsinformation

När denna produkt kasseras ska den hanteras och återvinnas enligt landets föreskrifter för att reducera miljöpåverkan. När du kasserar produkten ska du kontakta en distributör eller representant i ditt land. Kontaktadresserna listas på EIZO-webbplatsen nedan.

<http://www.eizoglobal.com>

Πληροφορίες ανακύκλωσης

Το προϊόν αυτό, όταν απορρίπτεται, πρέπει να συλλέγεται και να ανακυκλώνεται σύμφωνα με τη νομοθεσία της χώρας σας έτσι ώστε να μην επιβαρύνει το περιβάλλον. Για να απορρίψετε το προϊόν, επικοινωνήστε με έναν αντιπρόσωπο ή μια θυγατρική εταιρεία στη χώρα σας.

Οι διευθύνσεις επικοινωνίας αναγράφονται στην τοποθεσία web της EIZO παρακάτω.

<http://www.eizoglobal.com>

Сведения по утилизации

По истечении срока службы данного продукта его следует принести на сборный пункт и утилизировать в соответствии с действующими предписаниями в вашей стране, чтобы уменьшить вредное воздействие на окружающую среду. Прежде чем выбросить данный продукт, обратитесь к дистрибьютору или в местное представительство компании в вашей стране.

Контактные адреса можно найти на веб-узле EIZO.

<http://www.eizoglobal.com>

Informatie over recycling

Wanneer u dit product wilt weggooien, moet het uit milieu-overwegingen worden verzameld en gerecycled volgens de betreffende wetgeving van uw land. Wanneer u dit product wilt weggooien, moet u contact opnemen met een distributeur of een partner in uw land.

De contactadressen worden vermeld op de volgende EIZO-website.

<http://www.eizoglobal.com>

Informação sobre reciclagem

Este produto, quando o deitar fora, deve ser recolhido e reciclado de acordo com a legislação do seu país para reduzir a poluição. Quando deitar fora este produto, contacte um distribuidor ou uma filial no seu país.

Os endereços de contacto estão listados no website do EIZO, abaixo.

<http://www.eizoglobal.com>

Oplysninger om genbrug

Dette produkt forventes ved bortskaffelse at blive indsamlet og genbrugt i overensstemmelse med lovgivningen i dit land for at reducere belastningen af miljøet. Når du bortskaffer denne produkt, skal du kontakte en distributør eller et tilknyttet selskab i dit land.

Adresseerne på kontaktpersonerne er angivet på EIZO's websted nedenfor.

<http://www.eizoglobal.com>

Kierrätystä koskevia tietoja

Tuote tulee hävittää kierrättämällä maan lainsäädännön mukaisesti ympäristön kuormittumisen vähentämiseksi. Kun hävität tuotteen, ota yhteyttä jälleenmyyjään tai tytäryhtiöön maassasi.

Yhteystiedot löytyvät EIZOn Internet-sivustolta.

<http://www.eizoglobal.com>

Wykorzystanie surowców wtórnych

Ten produkt po zużyciu powinien być zbierany i przetwarzany zgodnie z krajowymi przepisami dotyczącymi ochrony środowiska. Wyrzucając ten produkt, należy skontaktować się z lokalnym dystrybutorem lub partnerem. Adresy kontaktowe można znaleźć we wskazanej poniżej witrynie internetowej firmy EIZO.

<http://www.eizoglobal.com>

Informace o recyklaci

Při likvidaci produktu musí být produkt vyzvednut a recyklován podle zákonů příslušné země, aby nedocházelo k zatěžování životního prostředí. Zbavujete-li se produktu, kontaktujte distributora nebo pobočku ve své zemi. Kontaktní adresy jsou uvedeny na následující webové stránce společnosti EIZO.

<http://www.eizoglobal.com>

Ringlussevõtu alane teave

Keskonnakoormuse vähendamiseks tuleks kasutatud tooted kokku koguda ja võtta ringlusse vastavalt teie riigi seadustele. Kui kõrvaldate käesoleva toote, võtke palun ühendust turustaja või filiaaliga oma riigis.

Kontaktisikud on toodud EIZO veebilehel järgmisel aadressil:

<http://www.eizoglobal.com>

Újrahasznosítási információ

Jelen terméket, amikor eldobjuk, az illető ország törvényei alapján kell összegyűjteni és újrahasznosítani, hogy csökkentésük a környezet terhelését. Amikor ezt a terméket eldobja, kérjük lépjen kapcsolatba egy országon belüli forgalmazóval vagy társvállalkozással.

A kapcsolat címei az EIZO alábbi weboldalán találhatóak felsorolva:

<http://www.eizoglobal.com>

Podatki o recikliranju

Ob koncu uporabe odslužen izdelek izročite na zbirno mesto za recikliranje v skladu z okoljevarstveno zakonodajo vaše države. Prosimo, da se pri odstranjevanju izdelka obrnete na lokalnega distributerja ali podružnico.

Kontaktne naslovi so objavljeni na spodaj navedenih spletnih straneh EIZO:

<http://www.eizoglobal.com>

Informácie o recyklácii

Pri likvidácii musí byť tento výrobok recyklovaný v súlade s legislatívou vašej krajiny, aby sa znížilo zaťaženie životného prostredia. Keď sa chcete zbaviť tohto výrobku, kontaktujte prosím distribútora alebo pobočku vo vašej krajine.

Zoznam kontaktných adries je uvedený na nasledovnej webovej stránke firmy EIZO:

<http://www.eizoglobal.com>

Pārstrādes informācija

Utilizējot šo produktu, tā savākšana un pārstrāde veicama atbilstoši jūsu valsts likumdošanas prasībām attiecībā uz slodzes uz vidi samazināšanu. Lai veiktu šī produkta utilizāciju, sazinieties ar izplatītāju vai pārstāvniecību jūsu valstī.

Kontaktadresses ir norādītas zemāk minētajā EIZO tīmekļa vietnē.

<http://www.eizoglobal.com>

Informacija apie gražinamąjį perdirbimą

Šalinant (išmetant) šiuos gaminius juos reikia surinkti ir perdirbti gražinamuoju būdu pagal jūsų šalies teisės aktus, siekiant sumažinti aplinkos teršimą. Kai reikia išmesti šį gaminį, kreipkitės į jūsų šalyje veikiančią gaminių pardavimo atstovybę arba jos filialą.

Kontaktiniai adresatai nurodyti EIZO interneto svetainėje.

<http://www.eizoglobal.com>

Информация относo рециклиране

При изхвърлянето на този продукт се предлага събирането и рециклирането му съобразно законите на вашата страна за да се намали замърсяването на околната среда. Когато искате да се освободите от този продукт, моля свържете се с търговския му представител или със съответните органи отговарящи за това във вашата страна.

Данните за връзка с нас са описани на следния Интернет сайт на EIZO:

<http://www.eizoglobal.com>

Informație referitoare la reciclare

Acest produs, când debarasat, trebuie colectat și reciclat conform legislației țării respective ca să reducem sarcina mediului. Când se debarasează de acest produs, vă rugăm să contactați un distribuitor sau un afiliat al țării respective. Adresele de contact le găsiți pe pagina de web al EIZO:
<http://www.eizoglobal.com>

معلومات عن إعادة التدوير

عند التخلص من هذا المنتج، من الضروري تجميعه وإعادة تدويره وفقاً للقوانين المتبعة في بلدك لتقليل العبء المسلط على البيئة. عندما تتخلص من هذا المنتج، يرجى الاتصال بموزع أو طرف منتسب إليه في بلدك. عناوين الاتصال مدرجة في موقع ايزو EIZO ادناه على شبكة الانترنت.
<http://www.eizoglobal.com>

Geri Dönüşüm Bilgisi

Bu ürünün, atılacağı zaman, ülkenizin çevre kirliliğinin azaltılması konusundaki mevzuatına göre toplanması ve yeniden değerlendirilmesi gerekmektedir. Ürünü atacağınız zaman lütfen ülkenizdeki bir distribütör veya ilgili kuruluşla temasa geçiniz. İrtibat adresleri aşağıdaki EIZO web sitesinde verilmiştir.
<http://www.eizoglobal.com>

Limited Warranty

EIZO Corporation (hereinafter referred to as "**EIZO**") and distributors authorized by EIZO (hereinafter referred to as the "**Distributors**") warrant, subject to and in accordance with the terms of this limited warranty (hereinafter referred to as the "**Warranty**"), to the original purchaser (hereinafter referred to as the "**Original Purchaser**") who purchased the product specified in this document (hereinafter referred to as the "**Product**") from EIZO or Distributors, that EIZO and Distributors shall, at their sole discretion, either repair or replace the Product at no charge if the Original Purchaser becomes aware within the Warranty Period (defined below) that the Product malfunctions or is damaged in the course of normal use of the Product in accordance with the description in the instruction manual attached to the Product (hereinafter referred to as the "**User's Manual**").

The period of this Warranty is three (3) years from the date of purchase of the Product (hereinafter referred to as the "**Warranty Period**"). EIZO and Distributors shall bear no liability or obligation with regard to the Product in relation to the Original Purchaser or any third parties other than as provided under this Warranty.

EIZO and Distributors will cease to hold or store any parts (excluding design parts) of the Product upon the expiration of five (5) years after the production of such parts is discontinued. In repairing the monitor, EIZO and Distributors will use renewal parts which comply with our QC standards. If the unit cannot be repaired due to its condition or the stockout of a relevant part, EIZO and Distributors may offer the replacement by a product with equivalent performance instead of repairing it.

The Warranty is valid only in the countries or territories where the Distributors are located. The Warranty does not restrict any legal rights of the Original Purchaser.

Notwithstanding any other provision of this Warranty, EIZO and Distributors shall have no obligation under this Warranty whatsoever in any of the cases as set forth below:

- (a) Any defect of the Product caused by freight damage, modification, alteration, abuse, misuse, accident, incorrect installation, disaster, faulty maintenance and/or improper repair by third party other than EIZO and Distributors;
- (b) Any incompatibility of the Product due to possible technical innovations and/or regulations;
- (c) Any deterioration of the sensor;
- (d) Any defect of the Product caused by external equipment;
- (e) Any defect of the Product on which the original serial number has been altered or removed;
- (f) Any normal deterioration of the product, particularly that of consumables, accessories, and/or attachments;
- (g) Any deformation, discoloration, and/or warp of the exterior of the product; and
- (h) Any defect of the Product caused by placement in a location where it may be affected by strong vibration or shocks.

To obtain service under the Warranty, the Original Purchaser must deliver the Product, freight prepaid, in its original package or other adequate package affording an equal degree of protection, assuming the risk of damage and/or loss in transit, to the local Distributor. The Original Purchaser must present proof of purchase of the Product and the date of such purchase when requesting services under the Warranty.

The Warranty Period for any replaced and/or repaired product under this Warranty shall expire at the end of the original Warranty Period.

EIZO OR DISTRIBUTORS ARE NOT RESPONSIBLE FOR ANY DAMAGE TO, OR LOSS OF, DATA OR OTHER INFORMATION STORED IN ANY MEDIA OR ANY PART OF ANY PRODUCT RETURNED TO EIZO OR DISTRIBUTORS FOR REPAIR.

EIZO AND DISTRIBUTORS MAKE NO FURTHER WARRANTIES, EXPRESSED OR IMPLIED, WITH RESPECT TO THE PRODUCT AND ITS QUALITY, PERFORMANCE, MERCHANTABILITY OR FITNESS FOR ANY PARTICULAR USE. IN NO EVENT SHALL EIZO OR DISTRIBUTORS BE LIABLE FOR ANY INCIDENTAL, INDIRECT, SPECIAL, CONSEQUENTIAL OR OTHER DAMAGE WHATSOEVER (INCLUDING, WITHOUT LIMITATION, DAMAGES FOR LOSS OF PROFIT, BUSINESS INTERRUPTION, LOSS OF BUSINESS INFORMATION, OR ANY OTHER PECUNIARY LOSS) ARISING OUT OF THE USE OR INABILITY TO USE THE PRODUCT OR IN ANY CONNECTION WITH THE PRODUCT, WHETHER BASED ON CONTRACT, TORT, NEGLIGENCE, STRICT LIABILITY OR OTHERWISE, EVEN IF EIZO OR DISTRIBUTORS HAVE BEEN ADVISED OF THE POSSIBILITY OF SUCH DAMAGES. THIS EXCLUSION ALSO INCLUDES ANY LIABILITY WHICH MAY ARISE OUT OF THIRD PARTY CLAIMS AGAINST THE ORIGINAL PURCHASER. THE ESSENCE OF THIS PROVISION IS TO LIMIT THE POTENTIAL LIABILITY OF EIZO AND DISTRIBUTORS ARISING OUT OF THIS LIMITED WARRANTY AND/OR SALES.



EIZO Corporation

153 Shimokashiwano, Hakusan, Ishikawa 924-8566 Japan

EIZO Europe GmbH

Belgrader Straße 2, 41069 Mönchengladbach, Germany



EIZO株式会社

〒 924-8566 石川県白山市下柏野町 153 番地

www.eizoglobal.com

www.eizo.co.jp

Copyright © 2017 - 2020 EIZO Corporation. All rights reserved.

00N0N008B1 
UM-UX2-AL 

2nd Edition - July, 2020 Printed in Japan.