



User's Manual

DuraVision® FDS1703-A Color LCD Monitor

Important







Please read this "User's Manual" carefully to familiarize yourself with safe and effective usage.

Please retain this manual for future reference.

-
- For the latest product information including the "User's Manual", refer to our web site :
www.eizoglobal.com
-

SAFETY SYMBOLS

This manual and this product use the safety symbols below. They denote critical information. Please read them carefully.

 <p>WARNING Failure to abide by the information in a WARNING may result in serious injury and can be life threatening.</p>	 <p>CAUTION Failure to abide by the information in a CAUTION may result in moderate injury and / or property or product damage.</p>
	<p>Indicates a warning or caution. For example,  indicates an “electrical shock” hazard.</p>
	<p>Indicates a prohibited action. For example,  means “Do not disassemble”.</p>

<For USA-California Only>
 CR Coin Lithium Battery contains Perchlorate Material - special handling may apply.
 See www.dtsc.ca.gov/hazardouswaste/perchlorate.

No part of this manual may be reproduced, stored in a retrieval system, or transmitted, in any form or by any means, electronic, mechanical, or otherwise, without the prior written permission of EIZO Corporation. EIZO Corporation is under no obligation to hold any submitted material or information confidential unless prior arrangements are made pursuant to EIZO Corporation’s receipt of said information. Although every effort has been made to ensure that this manual provides up-to-date information, please note that EIZO monitor specifications are subject to change without notice.

PRECAUTIONS



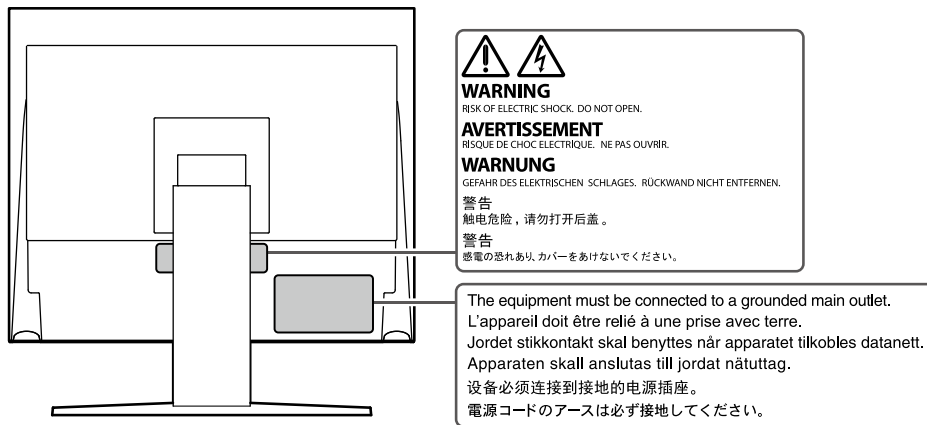

IMPORTANT

- This product has been adjusted specifically for use in the region to which it was originally shipped. If the product is used outside the region, it may not operate as specified in the specifications.
- To personal safety and proper maintenance, please read carefully this section and the caution statements on the monitor.

Location of the Caution Statements



Symbols on the unit

Symbol	This symbol indicates	
	Power button:	Press to turn the monitor's power on or off.
	Alternating current	
	Alerting electrical hazard	
	CAUTION:	Refer to "SAFETY SYMBOLS" (page 2).

WARNING

If the unit begins to emit smoke, smells like something is burning, or makes strange noises, disconnect all power connections immediately and contact your EIZO representative for advice. Attempting to use a malfunctioning unit may result in fire, electric shock, or equipment damage.

Do not disassemble or modify the unit.

Opening the cabinet or modifying the unit may result in fire, electric shock, or burn.



Refer all servicing to qualified service personnel.

Do not attempt to service this product yourself as opening or removing covers may result in fire, electric shock, or equipment damage.

Keep small objects or liquids away from the unit.

Small objects accidentally falling through the ventilation slots into the cabinet or spillage into the cabinet may result in fire, electric shock, or equipment damage. If an object or liquid falls/spills into the cabinet, unplug the unit immediately. Have the unit checked by a qualified service engineer before using it again.



Place the unit at a sturdy and stable place.

A unit placed on an inadequate surface may fall and result in injury or equipment damage. If the unit falls, disconnect the power immediately and ask your local EIZO representative for advice. Do not continue using a damaged unit. Using a damaged unit may result in fire or electric shock.

Use the unit in an appropriate location.

Otherwise, fire, electric shock, or equipment damage may result.

- Do not place outdoors.
- Do not place in any form of transportation (ships, aircraft, trains, automobiles, etc.).
- Do not place in dusty or humid environments.
- Do not place in locations where water may be splashed on the screen (bathrooms, kitchens, etc.)
- Do not place in locations where steam comes in direct contact with the screen.
- Do not place near heat generating devices or humidifiers.
- Do not place in locations where the product is subject to direct sunlight.
- Do not place in environments with inflammable gas.
- Do not place in environments with corrosive gases (such as sulfur dioxide, hydrogen sulfide, nitrogen dioxide, chlorine, ammonia, and ozone)
- Do not place in environments with dust, components that accelerate corrosion in the atmosphere (such as sodium chloride and sulfur), conductive metals, and so on



To avoid danger of suffocation, keep the plastic packing bags away from babies and children.

Use the enclosed power cord and connect to the standard power outlet in your country.

Be sure to use within the rated voltage of the power cord. Otherwise, fire or electric shock may result.

Power supply: 100-240Vac 50/60Hz

To disconnect the power cord, grasp the plug firmly and pull.

Tugging on the cord may damage and result in fire or electric shock.



The equipment must be connected to a grounded main outlet.

Failure to do so may result in fire or electric shock.



Use the correct voltage.

- The unit is designed for use with a specific voltage only. Connection to another voltage than specified in this "Instructions for Use" may cause fire, electric shock, or equipment damage.
Power supply: 100-240Vac 50/60Hz
 - Do not overload your power circuit, as this may result in fire or electric shock.
-

 **WARNING**

Handle the power cord with care.

- Do not place the cord underneath the unit or other heavy objects.
- Do not pull on or tie the cord.

If the power cord becomes damaged, stop using it. Using of a damaged cord may result in fire or electric shock.



Never touch the plug and power cord if it begins to thunder.

Touching them may result in electric shock.



When attaching an arm stand, please refer to the user's manual of the arm stand and install the unit securely.

Otherwise, the unit may become detached, resulting in injury and/or equipment damage. Before installation, make sure that desks, walls, or any other installation surface has adequate mechanical strength. If the unit falls, please ask your local EIZO representative for advice. Do not continue using a damaged unit. Using a damaged unit may result in fire or electric shock. When reattaching the tilt stand, please use the same screws and tighten them securely.

Do not touch a damaged LCD panel directly with bare hands.

Liquid crystal is poisonous. If any part of your skin comes in direct contact with the panel, wash thoroughly. If liquid crystal enters your eyes or mouth, immediately flush with large amounts of water and seek medical attention.





CAUTION

Handle with care when carrying the unit.

Disconnect the power cord and cables when moving the unit. Moving the unit with the power cord or cables attached is dangerous and may result in injury.

Carry or place the unit according to the correct specified methods.

- When carrying, grasp and firmly hold the unit as shown in the illustration below.
- Monitors of size 30 inches and above are heavy. When unpacking and/or carrying the monitor, ensure at least two people are utilized.

Dropping the unit may result in injury or equipment damage.

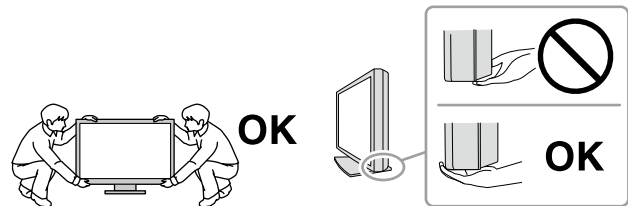

Do not block the ventilation slots on the cabinet.

- Do not place any objects on the ventilation slots.
- Do not install the unit in a place with poor ventilation or inadequate space.
- Do not use the unit laid down or upside down.

Blocking the ventilation slots prevents proper airflow and may result in fire, electric shock, or equipment damage.



Do not touch the plug with wet hands.

Doing so may result in electrical shock.



Use an easily accessible power outlet.

This is to facilitate disconnecting the power in case of a problem.

Periodically clean the area around the power plug and the ventilation slot of the monitor.

Dust, water, or oil on the plug may result in fire.

Unplug the unit before cleaning it.

Cleaning the unit while it is plugged into a power outlet may result in electric shock.

If you plan to leave the unit unused for an extended period of time, disconnect the power cord from the wall socket after turning off the power switch for the safety and the power conservation.

Notice for this monitor

This product is suited for displaying surveillance camera images.

This product has been adjusted specifically for use in the region to which it was originally shipped. If the product is used outside the region, it may not operate as specified in the specifications.

This product may not be covered by warranty for uses other than those described in this manual.

The specifications noted in this manual are only applicable when the following are used:

- Power cords provided with the product
 - Signal cables specified by us
-

Only use optional products manufactured or specified by us with this product.

If you place this product on a lacquer-coated desk, the color may adhere to the bottom of the stand due to the composition of the rubber. Check the desk surface before use.

It takes about 30 minutes (under our measurement conditions) for the monitor display to stabilize. Please wait 30 minutes or more after the monitor power has been turned on, and then adjust the monitor.

Monitors should be set to a lower brightness to prevent a loss in the screen quality caused by long-term use and to maintain stable use.

When the screen image is changed after displaying the same image for extended periods of time, an afterimage may appear. Use the screen saver or power save function to avoid displaying the same image for extended periods of time. Depending on the image, an afterimage may appear even if it was displayed for a short period of time. To remove such a phenomenon, change the image or keep the power turned off for several hours.

If the monitor displays continuously over a long period of time, dark smudges or burn-in may appear. To maximize the life of the monitor, we recommend the monitor be turned off periodically.

Periodic cleaning is recommended to keep the monitor looking new and to prolong its operation lifetime (refer to "Cleaning" (page 8)).

The LCD panel is manufactured using high-precision technology. Although, missing pixels or lit pixels may appear on the LCD panel, this is not a malfunction. Percentage of effective dots: 99.9994 % or higher.

The backlight of the LCD panel has a fixed lifetime. Depending on the usage pattern, such as usage for long continuous periods, the lifespan of the backlight may run out sooner, requiring replacement. When the screen becomes dark or begins to flicker, please contact your local EIZO representative.

Do not press on the LCD panel or edge of the frame strongly, as this may result in display malfunctions, such as interference patterns, etc. If pressure is continuously applied to the LCD panel surface, the liquid crystal may deteriorate or the LCD panel may be damaged. (If the pressure marks remain on the panel, leave the monitor with a black or white screen. The symptom may disappear.)

Do not scratch or press on the LCD panel with any sharp objects, at this may result in damage to the LCD panel. Do not attempt to brush with tissues as this may scratch the panel.

When the monitor is cold and brought into a room or the room temperature goes up quickly, dew condensation may occur on the interior and exterior surfaces of the monitor. In that case, do not turn the monitor on. Instead wait until the dew condensation disappears, otherwise it may cause some damage to the monitor.

Cleaning

The stains on the cabinet and LCD panel surface can be removed by moistening part of a soft cloth with water or by using ScreenCleaner (available as an option).

Attention

- Chemicals such as alcohol and antiseptic solution may cause gloss variation, tarnishing, and fading of the cabinet or LCD panel, and also quality deterioration of the image.
 - Never use thinner, benzene, wax, or abrasive cleaner as they may damage the cabinet or LCD panel surface.
-

To use the monitor comfortably

- An excessively dark or bright screen may affect your eyes. Adjust the brightness of the monitor according to the environmental conditions.
- Staring at the monitor for a long time tires your eyes. Take a 10-minute rest every hour.

CONTENTS

PRECAUTIONS	3	Appendix	31
IMPORTANT	3	Trademark	31
Notice for this monitor	7	License	31
Cleaning	8	Copyright	31
To use the monitor comfortably	8	Warning for Radio interference	32
CONTENTS	9	LIMITED WARRANTY	33
Chapter 1 Introduction	10	Recycling Information / Informations sur le	
1-1. Features	10	recyclage	i
1-2. Package Contents	10		
1-3. Controls and Functions	11		
Chapter 2 Connecting Cables	12		
2-1. Connecting	12		
2-2. Turning On the Power	14		
2-3. Adjusting the Screen Height and Angle	14		
Chapter 3 Basic Adjustment/Setting	15		
3-1. How to Operate the Buttons	15		
3-2. Switching Input Signals	15		
3-3. Adjusting the Brightness	16		
3-4. Adjusting Volume	16		
Chapter 4 Advanced Adjustment/Setting	17		
4-1. Basic Operation of the Setting Menu	17		
4-2. Setting Menu Functions	18		
● Color Adjustment	18		
● Signal Settings	20		
● Preferences	23		
● Language	23		
● Information	23		
Chapter 5 Administrator Settings	24		
5-1. Basic Operation of the "Administrator			
Settings" Menu	24		
5-2. "Administrator Settings" Menu Functions	25		
Chapter 6 Troubleshooting	26		
6-1. No Picture	26		
6-2. Imaging Problems	26		
6-3. Other Problems	26		
Chapter 7 Reference	27		
7-1. Attaching an Optional Arm	27		
7-2. Connecting Multiple External Devices	28		
7-3. Specifications	29		

Chapter 1 Introduction

Thank you very much for choosing an EIZO color LCD monitor.

1-1. Features

- 17.0-inch screen
- SXGA (1280 × 1024) display compliant
- Equipped with two types of input terminals
 - HDMI connector
PCs and audio-visual devices are supported
Displays HDCP (High-bandwidth Digital Content Protection) protected contents.
 - BNC connector
Supported formats: NTSC, PAL, SECAM
- A 2-year long-term warranty for 24-hour continuous use

1-2. Package Contents

Check that all the following items are included in the packaging box. If any items are missing, contact your local EIZO representative.

Note

- Please retain the packing materials for future transport of the monitor.
-

- LCD Monitor
- Power cord
- User's Manual (Limited Warranty included)
- Contact Addresses
- Connector clamp (for HDMI cable)

1-3. Controls and Functions

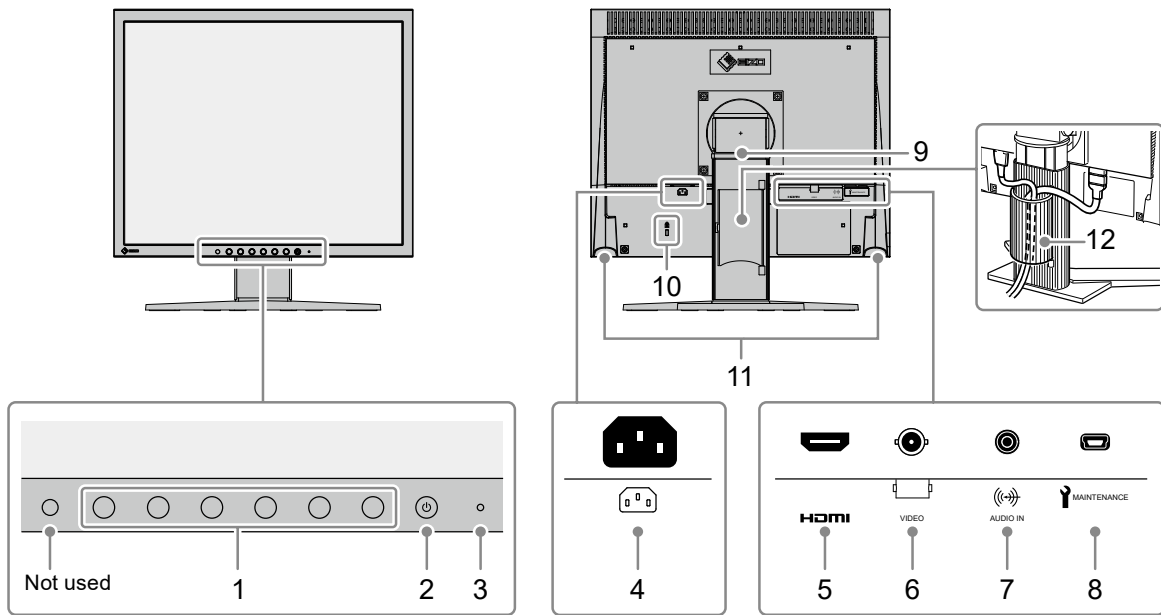

1	Operation button	Displays menus. Operate the switches according to the operation guide.
2	⏻ button	Turns the power on or off.
3	Power indicator	Indicates the monitor's operation status. Blue: Normal operation status Orange: Power saving mode
4	Power connector	Connects the power cord.
5	Input signal connector (HDMI)	HDMI connector
6	Input signal connector (VIDEO)	BNC connector
7	Stereo mini jack	If you connect to an external device using a stereo mini jack cable, you can output external audio from the monitor. Used when "VIDEO" is selected for the input signal.
8	mini USB	For maintenance use. Not for normal use.
9	Stand*1	Used to adjust the height and angle (tilt, swivel, rotation) of the monitor screen.
10	Security lock slot	Complies with Kensington's MicroSaver security system.
11	Speakers	Outputs audio.
12	Cable holder	Covers the monitor cables.

*1 An optional arm (or an optional stand) can be attached by removing the stand (see "7-1. Attaching an Optional Arm" (page 27)).

Chapter 2 Connecting Cables

2-1. Connecting

1. Connects to external equipment compatible with the monitor.

- When connecting to a PC or digital video equipment: see page 12
- When connecting to analog video equipment: see page 13

● When connecting to a PC or digital video equipment

Attention

- When replacing the current monitor with this monitor, be sure to change the PC or digital video equipment settings for the resolution and vertical scan frequency to those appropriate for this monitor.

Compatible Resolutions/Frequencies

The monitor supports the following resolutions.

Resolution	Vertical scan frequency (Hz)	Interlace	Progressive
640 × 480	59.94 / 60	-	√
720 × 400	70	-	√
720 × 480	59.94 / 60	√	√
720 × 576	50	√	√
800 × 600	60	-	√
1024 × 768	60	-	√
1280 × 720	50 / 59.94 / 60	-	√
1280 × 960	60	-	√
1280 × 1024 ^{*1}	60	-	√
1920 × 1080 ^{*2}	50 / 59.94 / 60	-	√

*1 Recommended resolution (Set this resolution.)

*2 The screen image is reduced in size when displayed.

1. Connect the monitor to a PC or digital video equipment with a signal cable that matches the connectors.

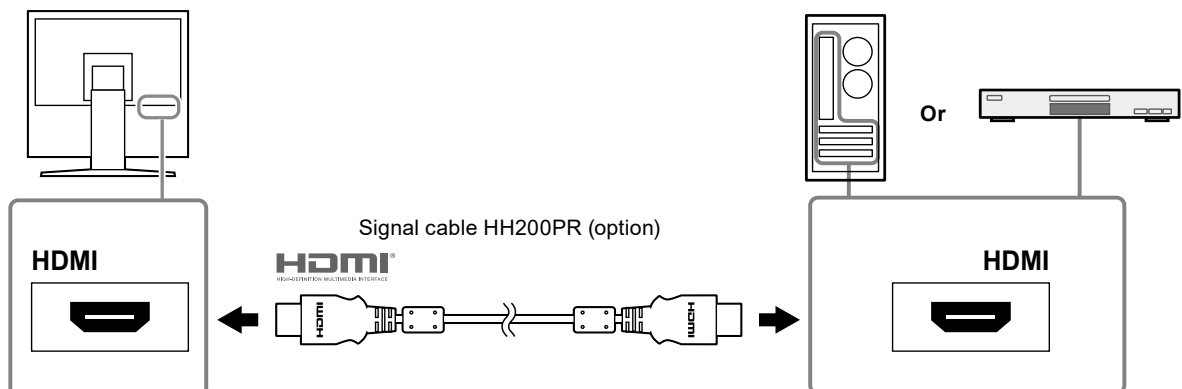

- You can use the connector clamp included in the packaging to fix the signal cable to the monitor.

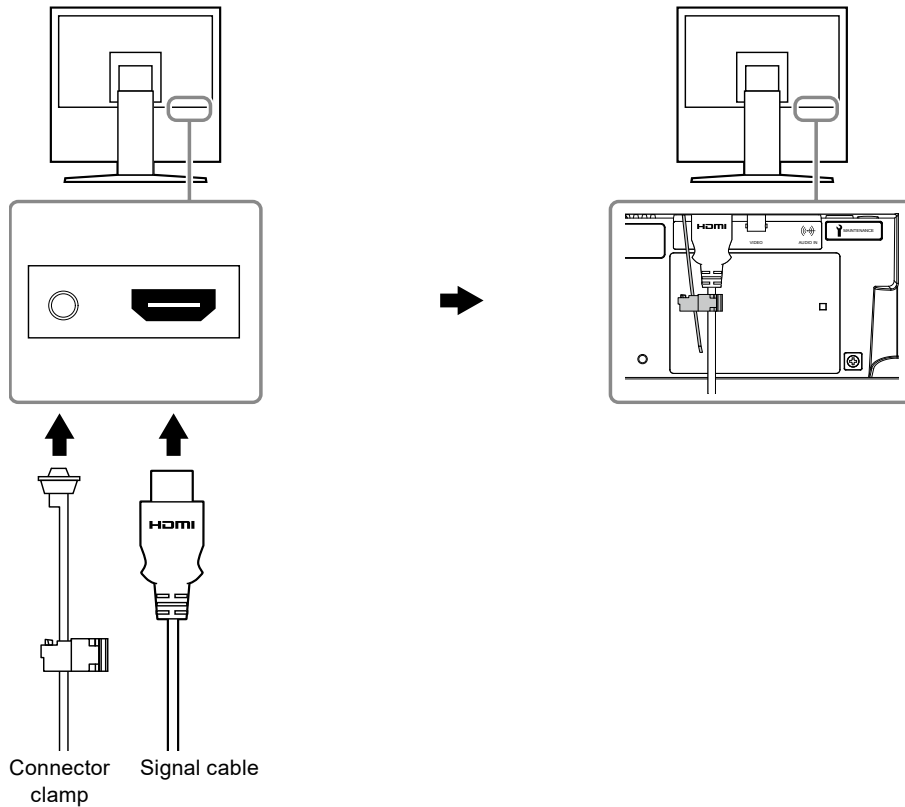

Attention

- When connecting with an HDMI cable, it is not required to connect an audio cable.

● When connecting to analog video equipment

- Connect the monitor to the analog video equipment with a signal cable that matches the connectors.

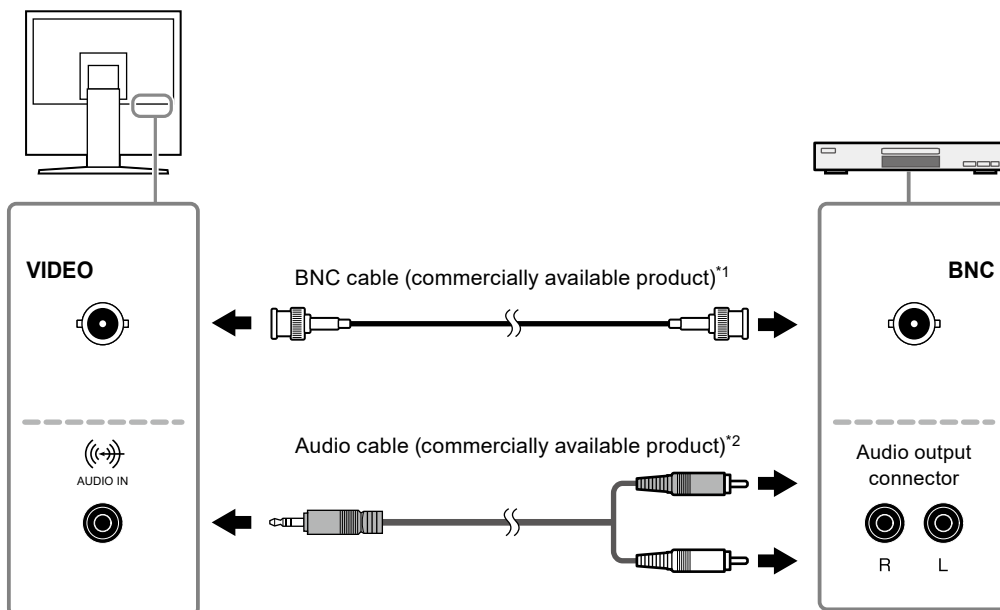

*1 If the video output connector for the analog video equipment has an RCA plug, use a commercially available BNC-RCA conversion adapter to make the connection.

*2 The audio cable to use varies depending on the device that is connected.

2. Plug the power cord of the monitor into a power outlet.

Plug the power cord into a power outlet and the Power connector on the monitor.

Attention

- Turn off the power after you are finished. Unplugging the power cord completely shuts off power supply to the monitor.
-

2-2. Turning On the Power

Press .

2-3. Adjusting the Screen Height and Angle

Hold left and right edge of the monitor with both hands, and adjust the screen height, tilt and swivel the screen to the best condition for working.

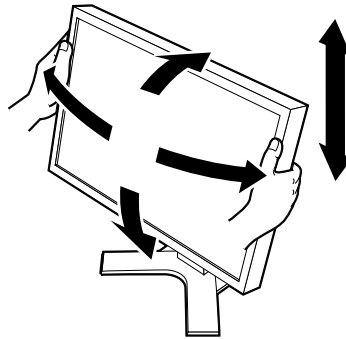

Attention

- Be sure that the cables are correctly connected.
-

Chapter 3 Basic Adjustment/Setting

This chapter describes the basic functions that can be adjusted and set using the operation buttons on the front of the monitor.

For advanced adjustment and setting procedures using the Setting menu, see “Chapter 4 Advanced Adjustment/Setting” (page 17).

3-1. How to Operate the Buttons

1. Displaying the operation guide

1. Press any of the buttons (excluding ).
- The operation guide appears on the screen.

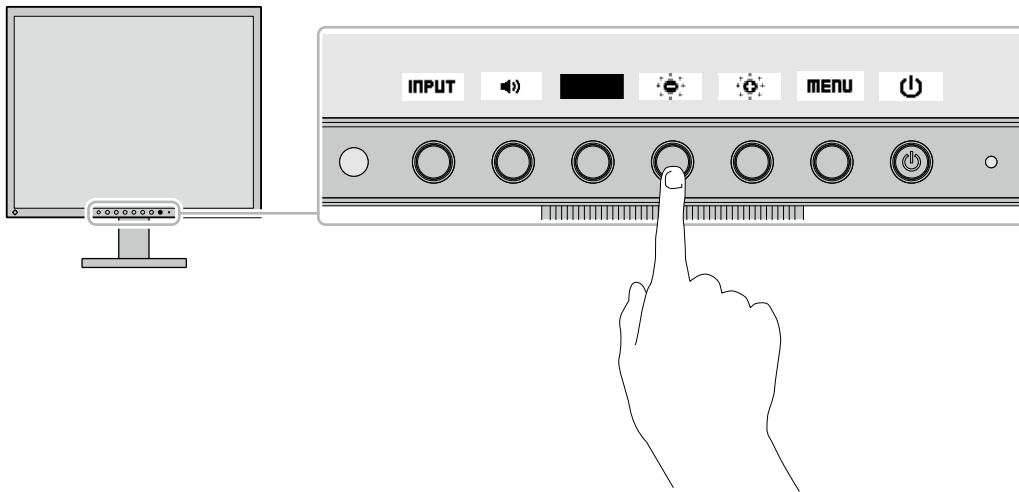

2. Adjusting/setting

1. Press the button of an item to adjust/set.
The Adjustment/Setting menu appears.
2. Perform adjustment/setting with the buttons and select **OK** to accept the changes.

3-2. Switching Input Signals

When a monitor has multiple signal inputs, the signal to display on-screen can be changed.

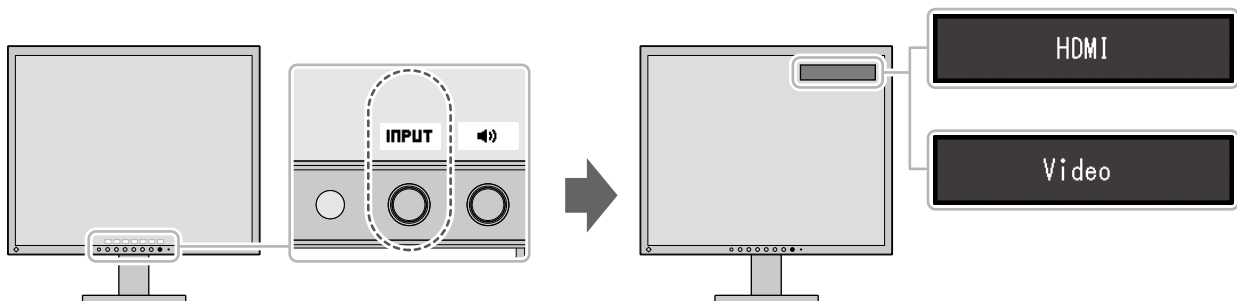

3-3. Adjusting the Brightness

The brightness of the screen can be adjusted to suit the installation environment or personal preference.

Settings

0 to 100

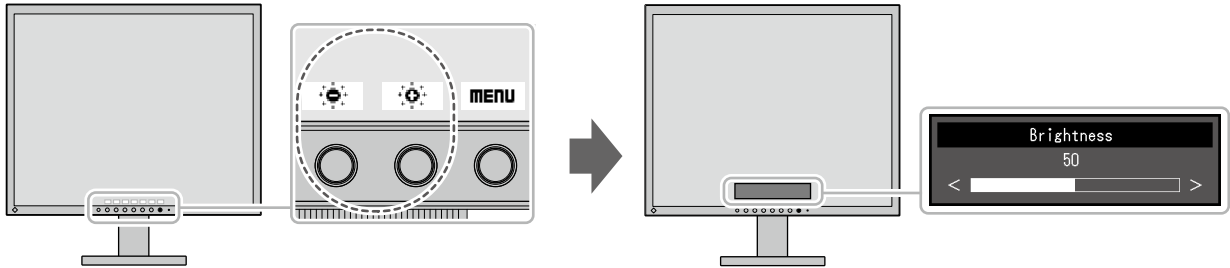

3-4. Adjusting Volume

The volume can be adjusted.

Settings

0 to 30

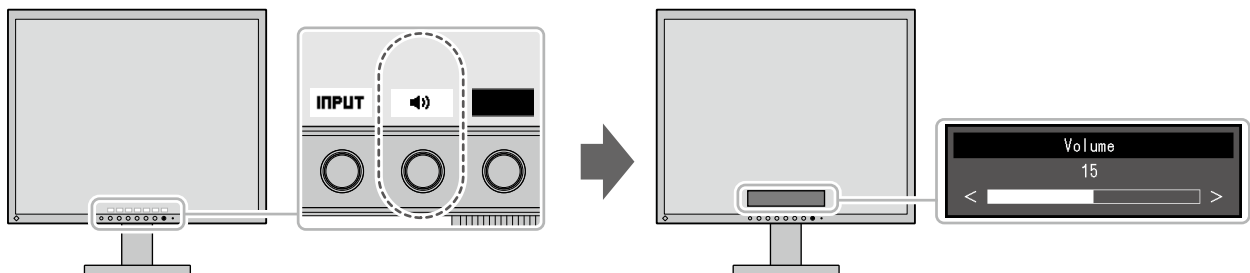

Chapter 4 Advanced Adjustment/Setting

This chapter describes the advanced monitor adjustment and setting procedures using the Setting menu. For basic functions, see “Chapter 3 Basic Adjustment/Setting” (page 15).

4-1. Basic Operation of the Setting Menu

1. Displaying the menu

1. Press any button (except ⏻).
The operation guide appears.
2. Select **MENU** .
The Setting menu appears.

2. Adjusting/setting

1. Select a menu to adjust/set with \blacktriangle \blacktriangledown and select **ENTER** .
The Sub menu appears.
2. Select an item to adjust/set with \blacktriangle \blacktriangledown and select **ENTER** .
The Adjustment/Setting menu appears.
3. Perform adjustment/setting with \blacktriangle \blacktriangledown or \blacktriangleleft \blacktriangleright and select **OK** to accept the changes.
The Sub menu appears.
Selecting **CANCEL** during adjustment/setting will cancel the adjustment/setting and restore the state prior to making changes.

3. Exiting

1. Select **CANCEL** or **RETURN** several times to terminate the Setting menu.

4-2. Setting Menu Functions

● Color Adjustment

The color setting status can be adjusted according to personal preference.

Attention

- It takes about 30 minutes for the monitor display to stabilize. Please wait 30 minutes or more after power to the monitor has been turned on before adjusting the monitor.
- The same image may be seen in different colors on multiple monitors due to differences between individual monitors. Make fine color adjustment visually when matching colors on multiple monitors.

Functions	Description
Brightness	<p>The screen brightness is adjusted by changing the brightness of the backlight (light source from the LCD back panel).</p> <p>Settings: 0 to 100</p> <p>Note</p> <ul style="list-style-type: none">• When you feel the image is bright even if the brightness is set to 0, adjust the contrast.
Contrast	<p>The brightness of the screen is adjusted by varying the video signal level.</p> <p>Settings: 0 % to 100 %</p> <p>Note</p> <ul style="list-style-type: none">• 100 % displays every color gradation.• When adjusting the monitor, it is recommended to perform brightness adjustment, which does not lose gradation characteristics, prior to contrast adjustment.• Perform contrast adjustment in the following cases.<ul style="list-style-type: none">- When you feel the image is bright even if the brightness is set to 0. (Set the contrast to lower than 100 %).
Temperature	<p>The color temperature can be adjusted.</p> <p>The color temperature is normally used to express the color of "White" and/or "Black" by a numerical value. The value is expressed in degrees "K" (Kelvin). The screen becomes reddish at a low color temperature, and bluish at a high color temperature, like the temperature of a flame. The gain preset values are set for each color temperature setting value.</p> <p>Settings: Native, 4000K to 10000K (in units of 100K), User</p> <p>Note</p> <ul style="list-style-type: none">• The value shown in "K" is available only as a reference.• "Gain" allows you to perform more advanced adjustment.• If set to "Native", the image is displayed in the preset color of the LCD panel (Gain: 100 for each RGB channel).• When gain is changed, the color temperature is changed to "User".
Gamma	<p>Adjust the gamma.</p> <p>The brightness of the monitor varies depending on the input signal, however, the variation rate is not simply proportional to the input signal. The control performed to keep the balance between the input signal and the brightness of the monitor is called "Gamma correction".</p> <p>Settings: 1.8, 2.0, 2.2, 2.4, Dynamic</p> <p>Note</p> <ul style="list-style-type: none">• If "Dynamic" is selected, the display is adjusted to emphasize low gradation contrast.

Functions		Description
Advanced Settings	Hue	<p>Adjust the hue.</p> <p>Settings: -100 to 100</p> <p>Note</p> <ul style="list-style-type: none"> Using this function may make some color gradations unavailable for display.
	Saturation	<p>Adjust the color saturation.</p> <p>Settings: -100 to 100</p> <p>Note</p> <ul style="list-style-type: none"> Using this function may make some color gradations unavailable for display. The minimum value (-100) changes the screen to monochrome.
	Gain	<p>The brightness of each color component red, green, and blue is called Gain. The hue of "white" can be changed by adjusting the gain.</p> <p>Settings: 0 % to 100 %</p> <p>Note</p> <ul style="list-style-type: none"> Using this function may make some color gradations unavailable for display. The gain value changes according to the color temperature. When gain is changed, the color temperature is changed to "User".
Reset		Resets the currently selected color adjustments back to the default settings.

● Signal Settings

The signal settings are used to configure advanced settings for input signals, such as the screen display size and color format.

The settings of each function differs depending on the input signal.

√: Settable -: Not settable

Functions	Input Signal		Description
	HDMI	Video	
Screen Size	√	√	<p>The screen size of the monitor display can be changed.</p> <p>Settings(HDMI): Auto, Full, Enlarged, Normal</p> <ul style="list-style-type: none"> "Auto" The monitor automatically changes the screen size according to the resolution information and aspect ratio information from the input signal. "Full" Displays an image in full screen. Images are distorted in some cases because the vertical rate is not equal to the horizontal rate. "Enlarged" Displays an image in full screen. However, since aspect ratios are maintained, part of an image may not be visible for the horizontal or vertical edge of the image. "Normal" Displays the image at the set resolution or at the size specified by the input signal. <p>Attention</p> <ul style="list-style-type: none"> If the resolution of the image is 1920×1080, the displayed resolution will be reduced even when set to "Full", "Enlarged" or "Normal". <p>Note</p> <ul style="list-style-type: none"> Example settings <ul style="list-style-type: none"> - "Full" <div data-bbox="1027 1375 1206 1518" data-label="Image"> </div> - "Enlarged" <div data-bbox="1027 1576 1206 1720" data-label="Image"> </div> - "Normal" <div data-bbox="1027 1765 1206 1908" data-label="Image"> </div>

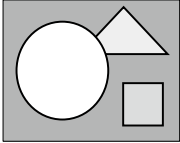
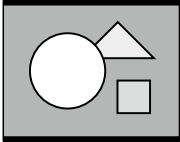
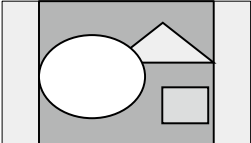
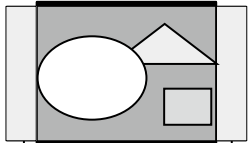
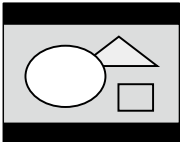
Functions	Input Signal		Description
	HDMI	Video	
Screen Size	√	√	<p>Settings (Video): Full, 4:3, 16:9a, 16:9b, 16:9c</p> <ul style="list-style-type: none"> "Full" Displays an image in full screen. Images are distorted in some cases because the vertical rate is not equal to the horizontal rate. "4:3" Displays the image in full screen while maintaining a 4:3 aspect ratio. "16:9a" Displays the full height of the image in full screen. Since the image is displayed while maintaining a 16:9 aspect ratio, the right and left sides of the image are cut off. "16:9b" Displays the image while maintaining a 16:9 aspect ratio. The right and left sides of the image are cut off. "16:9c" Displays the image in full screen while maintaining a 16:9 aspect ratio. <p>Note</p> <ul style="list-style-type: none"> Example settings <ul style="list-style-type: none"> - "Full"  - "4:3"  - "16:9a"  <p>└─ Portion that is cut off</p> - "16:9b"  <p>└─ Portion that is cut off</p> - "16:9c" 

√: Settable -: Not settable

Functions	Input Signal		Description
	HDMI	Video	
Input Color Format	√	-	<p>The color space of the input signal can be specified. Try changing this setting if colors are not displayed correctly.</p> <p>Settings: Auto*¹, YUV 4:2:2, YUV 4:4:4, RGB</p>
Input Range	√	-	<p>Depending on the video reproduction device, there may be a restriction on black and white video signal levels output to the monitor. This kind of signal is called "Limited range". On the other hand, unlimited signals are called "Full range".</p> <p>Settings: Auto*¹, Full, Limited</p> <ul style="list-style-type: none"> • "Auto" Input signal brightness range is automatically judged and is displayed appropriately (recommended setting). Depending on the video reproduction device, Limited range and Full range may not be able to be judged by the monitor. In such a case, selecting "Full" or "Limited" will allow it to be displayed appropriately. • "Full" To be selected in case of Full range signals. Appropriate display can be obtained when this is selected, in case both blacks and whites are corrupted. • "Limited" To be selected in case of Limited range signals. In case this is selected, the output signal range is expanded from 0 to 255 to obtain an appropriate display when black is pale and white is dull.
Noise Reduction	√	√	<p>Use this function to reduce noise and roughness in images.</p> <p>Settings: Off, Light, Middle, Heavy</p> <p>Note</p> <ul style="list-style-type: none"> • Using the Noise Reduction function may lead to deterioration of fine images.
Sharpness	√	√	<p>This function allows you to emphasize the outline of the image by emphasizing the color difference between the pixels composing the image and to improve a sense of quality and materiality.</p> <p>Settings: Off, Light, Middle, Heavy</p>
Overscan	-	√	<p>Switches the display range of the input image (overscan). If "Off" is selected, most input images will be displayed.</p> <p>Settings: Off, On</p> <p>Note</p> <ul style="list-style-type: none"> • Depending on the input signal, noise may be visible at the edges of the screen.

*1 Only enabled when input signal information for automatically determining the setting is detected

● Preferences

The monitor's settings can be configured to suit the usage environment or personal preference.

Functions	Description
Up View	Optimizes the display for viewing the screen from below, so that the display appears similar to when viewing the screen from the front. Settings: Off, -20°, -40°
Power Save	The monitor or digital video equipment can be set to enter power saving mode according to the state of the PC. The monitor changes to power saving mode about 15 seconds after signal input ceases to be detected. When the monitor has shifted to power saving mode, images are not displayed on the screen. <ul style="list-style-type: none"> Exiting power saving mode <ul style="list-style-type: none"> If the monitor receives input, it automatically exits power saving mode and returns to the normal display mode. Settings: On, Off Note <ul style="list-style-type: none"> At the time of shifting to power saving mode, a message that indicates the transition is displayed 5 seconds in advance. When you are not using the monitor, disconnect the power plug to cut off power consumption completely. Power consumption varies even when the stereo mini jack cable is connected.
Monitor Reset	Restore all settings to their default values except for the following settings. <ul style="list-style-type: none"> Settings in the "Administrator Settings" menu Note <ul style="list-style-type: none"> For details on the "Administrator Settings" menu, see "Chapter 5 Administrator Settings" (page 24).

● Language

The display language for menus and messages can be selected.

Settings

English, German, French, Spanish, Italian, Swedish, Japanese, Simplified Chinese, Traditional Chinese

● Information

Monitor information (product name, serial number, resolution or signal format, input signal) can be checked.

Chapter 5 Administrator Settings

This chapter describes how to configure monitor operation using the "Administrator Settings" menu. This menu is for administrators. Configuration on this menu is not required for normal monitor use.

5-1. Basic Operation of the "Administrator Settings" Menu

1. Displaying the menu

1. Press $\text{\textcircled{P}}$ to turn off the monitor.
2. While pressing the third button from the left, press $\text{\textcircled{P}}$ for more than 2 seconds to turn on the monitor.

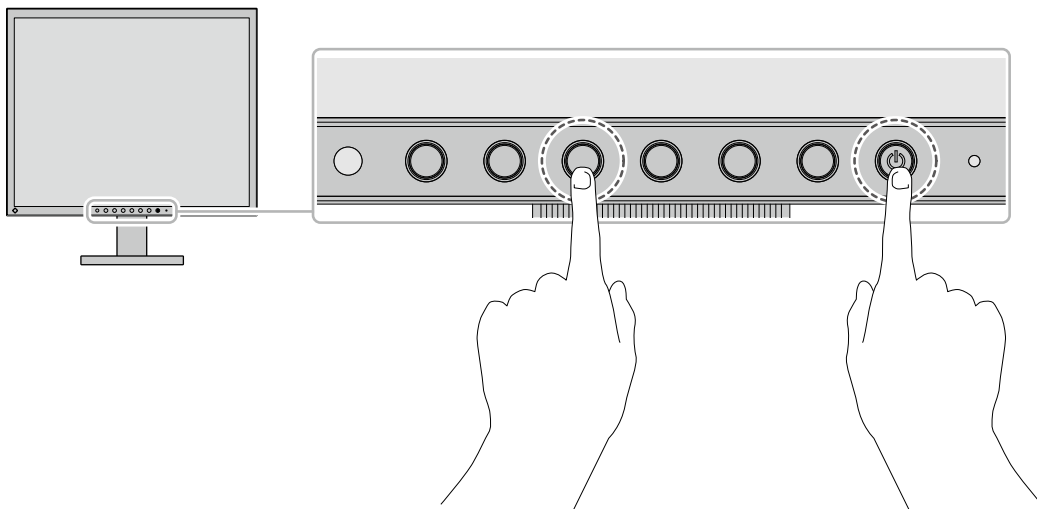

The "Administrator Settings" menu appears.

2. Setting

1. Choose an item to set with \blacktriangle \blacktriangledown , and then select **ENTER**.
The Adjustment/Setting menu appears.
2. Set with \blacktriangleleft \blacktriangleright and select **OK**.
The "Administrator Settings" menu appears.

3. Applying and exiting

1. Select "Apply", and then select **ENTER**.
The settings are confirmed and the "Administrator Settings" menu quits.

5-2. "Administrator Settings" Menu Functions

Function	Description
Auto Input Detection	<p>This product automatically recognizes the connector through which signals are input and displays images on the screen accordingly.</p> <p>Settings: Off, On</p> <ul style="list-style-type: none"> • "Off" <p>The input signal is selected manually. The input signal to display can be selected using the operation button (INPUT) on the front of the monitor. For more information, see "3-2. Switching Input Signals" (page 15).</p> • "On" <p>The input signal is selected automatically. When connecting to multiple PCs or pieces of digital video equipment, if the PCs or digital video equipment turn off or enter power saving mode, any other available signal is displayed automatically.</p> <p>Note</p> <ul style="list-style-type: none"> • When this function is set to "On", the monitor only enters power saving mode after all connected PCs or digital video equipment have been turned off or have entered power saving mode.
On-Screen Logo	<p>When the monitor is turned on, the EIZO logo appears on the screen. When this function is set to "Off", the EIZO logo does not appear.</p> <p>Settings: On, Off</p>
Key Lock	<p>In order to prevent changes to settings, the operation buttons on the front of the monitor can be locked.</p> <p>Settings: Off, Menu, All</p> <ul style="list-style-type: none"> • "Off" <p>Enables all buttons.</p> • "Menu" <p>Locks the MENU button.</p> • "All" <p>Locks all buttons except the power button.</p>

Chapter 6 Troubleshooting

6-1. No Picture

Problems	Possible cause and remedy
1. No picture <ul style="list-style-type: none">Power indicator does not light up.	<ul style="list-style-type: none">Check whether the power cord is connected properly.Press  on the monitor.Turn off the power, and then turn it on again a few minutes later.
<ul style="list-style-type: none">Power indicator is lighting orange.	<ul style="list-style-type: none">Move the mouse or press any key on the keyboard.Check whether the power of the external device is turned on.Check whether the signal cable is connected properly.Switch the input signal.
<ul style="list-style-type: none">Power indicator is lighting blue.	<ul style="list-style-type: none">Check whether the power of the external device is turned on.Switch the input signal.Adjust using "Brightness" and "Contrast" (see page 18).

6-2. Imaging Problems

Problems	Possible cause and remedy
1. The screen is too bright or too dark.	<ul style="list-style-type: none">Adjust using "Brightness" or "Contrast" (see page 18). (The LCD monitor backlight has a limited life span. If the screen becomes dark or begins to flicker, contact your local representative.)The symptom may appear depending on the angle of the monitor. Try adjusting the settings for viewing the screen from below ("Up View" (page 23)) and the tilt angle of the monitor.
2. Green/red/blue/white/dark dots remain on the screen.	<ul style="list-style-type: none">This is due to LCD panel characteristics and not a malfunction.
3. Interference patterns or pressure marks remain on the LCD panel.	<ul style="list-style-type: none">Display a white or black image over the entire screen. The symptom may disappear.
4. Afterimages appear.	<ul style="list-style-type: none">Afterimages are particular to LCD monitors. Avoid displaying the same image for a long time.Use the screen saver or power saving function to avoid displaying the same image for extended periods of time.

6-3. Other Problems

Problems	Possible cause and remedy
1. The Setting menu does not appear.	<ul style="list-style-type: none">Check whether the operation button lock function works (see "Key Lock" (page 25)).
2. No audio output.	<ul style="list-style-type: none">Check whether the stereo mini jack cable is connected properly.Check whether volume is set to 0.Check the PC or digital video equipment and the audio playback software to see whether they are configured correctly.When displaying images from a device connected to the input signal connector (HDMI), audio from the stereo mini jack cable is not output.When displaying images from a device connected to the input signal connector (VIDEO), audio from the HDMI cable is not output.
3. Items cannot be selected on the Setting menu.	<ul style="list-style-type: none">Items displayed in gray cannot be changed.

Chapter 7 Reference

7-1. Attaching an Optional Arm

An optional arm (or an optional stand) can be attached by removing the stand section. Please refer to our web site for the corresponding optional arm (or optional stand).

www.eizoglobal.com

Attention

- When attaching an arm or stand, follow the instructions of their User's Manual.
- When using another manufacturer's arm or stand, confirm the following in advance and select one conforming to the VESA standard. Use the screws securing the unit and the stand.
 - Clearance between screw holes: 100 mm × 100 mm
 - Plate thickness: 2.6 mm
 - Must be strong enough to support weight of the monitor unit (excluding the stand) and attachments such as cables.
- When using an arm or stand, attach it to meet the following tilt angles of the monitor.
 - Up 60 degrees, down 45 degrees (horizontal display)
 - Up 45 degrees, down 45 degrees (vertical display, 90 degrees clockwise)
- Connect the cables after attaching an arm or stand.
- The monitor, arm, and stand are heavy. Dropping them may result in injury or equipment damage.
- Check periodically that the screws are tight enough. If the screws are not tight enough, the monitor may come unattached. This may be the cause of injury or damage.

● Attachment procedure

1. To prevent damaging the panel surface, lay the monitor on a soft cloth spread on a stable surface with the LCD panel surface facing down.

2. Remove the stand.

Prepare a screwdriver. Using a screwdriver, remove the screws (four) securing the unit and the stand.

3. Attach the arm or stand to the monitor.

Fastening torque: 1.0 N·m to 1.4 N·m

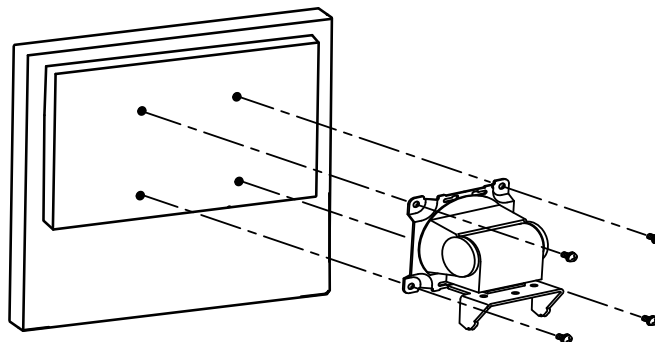

7-2. Connecting Multiple External Devices

The product allows you to connect multiple external devices and switch between them for display.

Connection examples

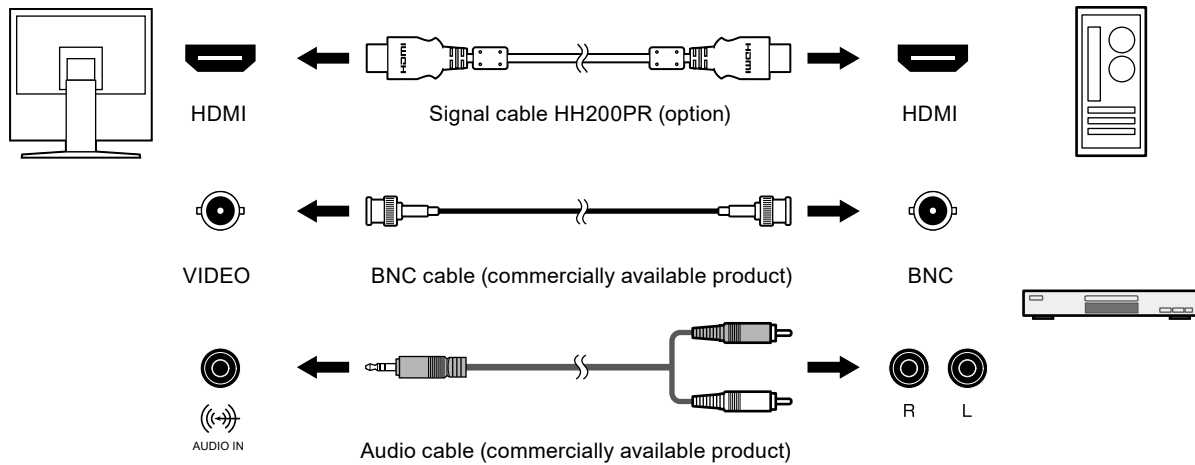

Note

- The input signal changes each time the operation button (**INPUT**) on the front of the monitor is selected. When the signal is switched, the active input port name appears at the top right corner of the screen.
- This product can automatically recognize the connector through which signals are input and display images on the screen accordingly. For more information, see "Auto Input Detection" (page 25).
- When the input signal is switched, the audio also switches.

7-3. Specifications

LCD Panel	Size	43.3 cm (17.0 inch)
	Type	TN Backlight: White LED
	Surface Treatment	Anti-Glare
	Surface Hardness	3H
	Viewing Angle	Horizontal 160°, Vertical 140° (CR: 10 or more)
	Dot Pitch	0.264 mm × 0.264 mm
	Response Time	Black-white-black: Approx. 20 ms
Resolution		1280 dots × 1024 lines
Display Area (Horizontal × Vertical)		337.9 mm × 270.3 mm
Max. Display Color		Approx. 16.77 million colors
PC Input	Horizontal Scan Frequency	15 kHz to 68 kHz
	Vertical Scan Frequency	49 Hz to 61 Hz
	Max. Dot Clock	148.5 MHz
	Input Signal Connector	HDMI (HDCP compatible)×1*1
Video Input	Supported Format	NTSC, PAL, SECAM
	Input Signal Connector	BNC × 1
	Signal Level	1.0 Vp-p/75 Ω
Audio	Speaker Output	0.5 W + 0.5 W
	Input Signal Connector	Stereo mini jack×1
	Audio Input Format	HDMI: 2 ch linear PCM (32 kHz / 44.1 kHz / 48 kHz)
Power Supply		100-240 VAC ±10 %, 50/60 Hz, 0.50-0.25 A
Power Consumption	Screen Display On	26 W or less
	Power Saving Mode	2.5 W or less (for single signal input, when audio cable is not connected)
	Power Off	0.4 W or less
Dimensions	Main Unit	367.0 mm (W) × 391.5 mm - 491.5 mm (H) × 205.0 mm (D)
	Main Unit (without stand)	367.0 mm (W) × 304.0 mm (H) × 59.0 mm (D)
Net. Weight	Main Unit	Approx. 5.2 kg
	Main Unit (without stand)	Approx. 3.4 kg
Movement Range	Tilt	Up 30°, Down 0°
	Swivel	Right 35°, Left 35°
	Vertical Rotation	Right 90°
Environmental Conditions	Temperature	Operating: 0 °C - 40 °C Transportation / Storage: -20 °C - 60 °C
	Humidity	Operating: 20 % - 80 % R.H. (no condensation) Transportation / Storage: 10 % - 92 % R.H. (no condensation)
	Air Pressure	Operating: 540 hPa - 1060 hPa Transportation / Storage: 200 hPa - 1060 hPa

*1 HDMI CEC (or mutual control) is not supported.

Main Default Settings

Functions	HDMI	Video
Brightness	100	
Volume	7	
Gamma	2.2	
Contrast	100 %	
Temperature	6500 K	
Screen Size	Auto	Full
Input Color Format	Auto	-
Input Range	Auto	-
Overscan	-	Off
Up View	Off	

Dimensions

Unit: mm

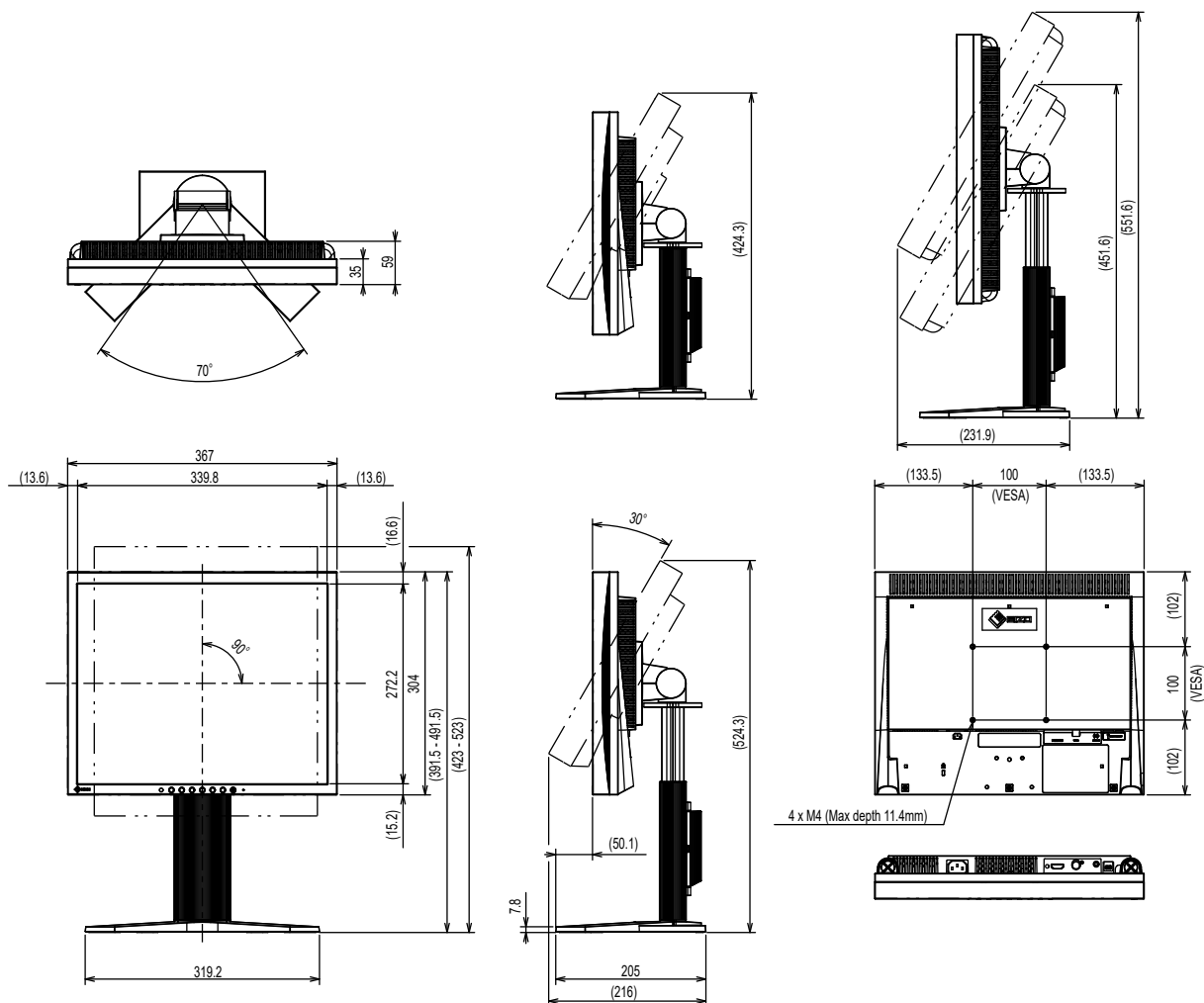

Appendix

Trademark

The terms HDMI and HDMI High-Definition Multimedia Interface, and the HDMI Logo are trademarks or registered trademarks of HDMI Licensing, LLC in the United States and other countries.

The DisplayPort Compliance Logo and VESA are registered trademarks of the Video Electronics Standards Association.

The SuperSpeed USB Trident Logo is a registered trademark of USB Implementers Forum, Inc.



The USB Power Delivery Trident Logos are trademarks of USB Implementers Forum, Inc.



DICOM is the registered trademark of the National Electrical Manufacturers Association for its standards publications relating to digital communications of medical information.

Kensington and Microsaver are registered trademarks of ACCO Brands Corporation.

Thunderbolt is a trademark of Intel Corporation in the United States and/or other countries.

Microsoft and Windows are registered trademarks of Microsoft Corporation in the United States and other countries.

Adobe is a registered trademark of Adobe Systems Incorporated in the United States and other countries.

Apple, macOS, Mac OS, OS X, Macintosh and ColorSync are registered trademarks of Apple Inc.

ENERGY STAR is a registered trademark of the United States Environmental Protection Agency in the United States and other countries.

EIZO, the EIZO Logo, ColorEdge, CuratOR, DuraVision, FlexScan, FORIS, RadiCS, RadiForce, RadiNET, Raptor and ScreenManager are registered trademarks of EIZO Corporation in Japan and other countries.

ColorEdge Tablet Controller, ColorNavigator, EcoView NET, EIZO EasyPIX, EIZO Monitor Configurator, EIZO ScreenSlicer, G-Ignition, i•Sound, Quick Color Match, RadiLight, Re/Vue, SafeGuard, Screen Administrator, Screen InStyle, ScreenCleaner and UniColor Pro are trademarks of EIZO Corporation.

All other company names, product names, and logos are trademarks or registered trademarks of their respective companies.

License

The bitmap font used for this product is designed by Ricoh Industrial Solutions Inc.

Copyright

Using the special functions, such as screen size change (ex. changing the horizontal and vertical ratio of images input) for commercial purposes or for the purpose of showing in public may violate copyright laws.

Warning for Radio interference

For U.S.A., Canada Only

FCC Supplier's Declaration of Conformity

We, the Responsible Party

EIZO Inc.

5710 Warland Drive, Cypress, CA 90630

Phone: (562) 431-5011

declare that the product

Trade name: EIZO

Model: DuraVision FDS1703-A

is in conformity with Part 15 of the FCC Rules. Operation of this product is subject to the following two conditions: (1) this device may not cause harmful interference, and (2) this device must accept any interference received, including interference that may cause undesired operation.

WARNING!

This equipment has been tested and found to comply with the limits for a Class A digital device, pursuant to Part 15 of the FCC Rules. These limits are designed to provide reasonable protection against harmful interference when the equipment is operated in a commercial environment. This equipment generates, uses, and can radiate radio frequency energy and if not installed and used in accordance with the instruction manual, may cause harmful interference to radio communications. Operation of this equipment in a residential area is likely to cause harmful interference in which case the user will be required to correct the interference at his own expense.

Changes or modifications not expressly approved by the party responsible for compliance could void the user's authority to operate the equipment.

Note

Use the attached specified cable below or EIZO signal cable with this monitor so as to keep interference within the limits of a Class A digital device.

- AC Cord
- Shielded Signal Cable (enclosed)

Canadian Notice

This Class A information technology equipment complies with Canadian ICES-003.

Cet équipement informatique de classe A est conforme à la norme NMB-003 du Canada.

For Europe, Australia, New Zealand, etc Only

Warning

Operation of this equipment in a residential environment could cause radio interference.

Warnung

Der Betrieb dieses Geräts in einer Wohnumgebung könnte Funkstörungen verursachen.

Avertissement

L'utilisation de cet équipement dans une zone résidentielle pourrait provoquer des interférences radio.

LIMITED WARRANTY

EIZO Corporation (hereinafter referred to as “**EIZO**”) and distributors authorized by EIZO (hereinafter referred to as the “**Distributors**”) warrant, subject to and in accordance with the terms of this limited warranty (hereinafter referred to as the “**Warranty**”), to the original purchaser (hereinafter referred to as the “**Original Purchaser**”) who purchased the product specified in this document (hereinafter referred to as the “**Product**”) from EIZO or Distributors, that EIZO and Distributors shall, at their sole discretion, either repair or replace the Product at no charge if the Original Purchaser becomes aware within the Warranty Period (defined below) that the Product malfunctions or is damaged in the course of normal use of the Product in accordance with the description in the instruction manual of the Product (hereinafter referred to as the “**User’s Manual**”).

The period of this Warranty is two (2) years from the date of purchase of the Product (hereinafter referred to as the “**Warranty Period**”). EIZO and Distributors shall bear no liability or obligation with regard to the Product in relation to the Original Purchaser or any third parties other than as provided under this Warranty.

EIZO and Distributors will cease to hold or store any parts (excluding design parts) of the Product upon expiration of seven (7) years after the production of the Product is discontinued. In repairing the monitor, EIZO and Distributors will use renewal parts which comply with our QC standards. If the unit cannot be repaired due to its condition or the stockout of a relevant part, EIZO and Distributors may offer the replacement by a product with equivalent performance instead of repairing it.

The Warranty is valid only in the countries or territories where the Distributors are located. The Warranty does not restrict any legal rights of the Original Purchaser.

Notwithstanding any other provision of this Warranty, EIZO and Distributors shall have no obligation under this Warranty whatsoever in any of the cases as set forth below:

- (a) Any defect of the Product caused by freight damage, modification, alteration, abuse, misuse, accident, incorrect installation, disaster, adherent dust, faulty maintenance and/or improper repair by third party other than EIZO and Distributors;
- (b) Any incompatibility of the Product due to possible technical innovations and/or regulations;
- (c) Any deterioration of the sensor, including measurement value of the sensor;
- (d) Any defect of the Product caused by external equipments;
- (e) Any defect of the Product caused by the use under environmental conditions other than EIZO and Distributors’ estimation;
- (f) Any deterioration of the attachments of the Product (e.g. cables, User’s Manual, CD-ROM, etc.);
- (g) Any deterioration of the consumables, and/or accessories of the Product (e.g. batteries, remote controller, touch pen, etc.);
- (h) Any deformation, discoloration, and/or warp of the exterior of the Product including that of the surface of the LCD panel;
- (i) Any defect of the Product caused by placement in a location where it may be affected by strong vibration or shocks;
- (j) Any defect of the Product caused by liquid leaking from battery;
- (k) Any deterioration of display performance caused by the deterioration of expendable parts such as the LCD panel and/or backlight, etc. (e.g. changes in brightness, changes in brightness uniformity, changes in color, changes in color uniformity, defects in pixels including burnt pixels, etc.);
- (l) Any deterioration or malfunction of the cooling fan caused by adherent dust.

To obtain service under the Warranty, the Original Purchaser must deliver the Product, freight prepaid, in its original package or other adequate package affording an equal degree of protection, assuming the risk of damage and/or loss in transit, to the local Distributor. The Original Purchaser must present proof of purchase of the Product and the date of such purchase when requesting services under the Warranty.

The Warranty Period for any replaced and/or repaired product under this Warranty shall expire at the end of the original Warranty Period.

EIZO OR DISTRIBUTORS ARE NOT RESPONSIBLE FOR ANY DAMAGE TO, OR LOSS OF, DATA OR OTHER INFORMATION STORED IN ANY MEDIA OR ANY PART OF ANY PRODUCT RETURNED TO EIZO OR DISTRIBUTORS FOR REPAIR.

EIZO AND DISTRIBUTORS MAKE NO FURTHER WARRANTIES, EXPRESSED OR IMPLIED, WITH RESPECT TO THE PRODUCT AND ITS QUALITY, PERFORMANCE, MERCHANTABILITY OR FITNESS FOR ANY PARTICULAR USE. IN NO EVENT SHALL EIZO OR DISTRIBUTORS BE LIABLE FOR ANY INCIDENTAL, INDIRECT, SPECIAL, CONSEQUENTIAL OR OTHER DAMAGE WHATSOEVER (INCLUDING, WITHOUT LIMITATION, DAMAGES FOR LOSS OF PROFIT, BUSINESS INTERRUPTION, LOSS OF BUSINESS INFORMATION, OR ANY OTHER PECUNIARY LOSS) ARISING OUT OF THE USE OR INABILITY TO USE THE PRODUCT OR IN ANY CONNECTION WITH THE PRODUCT, WHETHER BASED ON CONTRACT, TORT, NEGLIGENCE, STRICT LIABILITY OR OTHERWISE, EVEN IF EIZO OR DISTRIBUTORS HAVE BEEN ADVISED OF THE POSSIBILITY OF SUCH DAMAGES. THIS EXCLUSION ALSO INCLUDES ANY LIABILITY WHICH MAY ARISE OUT OF THIRD PARTY CLAIMS AGAINST THE ORIGINAL PURCHASER. THE ESSENCE OF THIS PROVISION IS TO LIMIT THE POTENTIAL LIABILITY OF EIZO AND DISTRIBUTORS ARISING OUT OF THIS LIMITED WARRANTY AND/OR SALES.

Recycling Information / Informations sur le recyclage

English

Français

Recycling Information

This product, when disposed of, is supposed to be collected and recycled according to your country's legislation to reduce environmental burden. When you dispose of this product, please contact a distributor or an affiliate in your country.

The contact addressees are listed on the EIZO website below.

www.eizoglobal.com

For recycling information for customers in Switzerland, please refer to the following website.

www.swico.ch

Informationen zum Thema Recycling

Dieses Produkt muss gemäß den Vorschriften Ihres Landes zur Entlastung der Umwelt recyclet werden. Wenden Sie sich bei der Entsorgung dieses Produkts an einen Verteiler oder eine Tochtergesellschaft in Ihrem Land.

Die Adressen zur Kontaktaufnahme sind auf der unten angegebenen Website von EIZO aufgeführt.

www.eizoglobal.com

Kunden in der Schweiz entnehmen Informationen zum Recycling der folgenden Website:

www.swico.ch

Informations sur le recyclage

Ce produit doit être jeté aux points de collecte prévus à cet effet et recyclé conformément à la législation de votre pays, afin de réduire l'impact sur l'environnement. Lorsque vous jetez ce produit, veuillez contacter un distributeur ou une société affiliée de votre pays.

Les adresses des distributeurs sont répertoriées sur le site Web EIZO ci-dessous.

www.eizoglobal.com

Pour les clients en Suisse, veuillez consulter le site Web suivant afin d'obtenir des informations sur le recyclage.

www.swico.ch

Información sobre reciclaje

Este producto debe desecharse y reciclarse según la legislación del país para reducir el impacto medioambiental.

Cuando desee deshacerse de este producto, póngase en contacto con un distribuidor o una filial de su país.

Encontrará las direcciones de contacto en el sitio web de EIZO que se indica a continuación.

www.eizoglobal.com

Informazioni sul riciclaggio

Per lo smaltimento e il riciclaggio del presente prodotto, attenersi alle normative vigenti nel proprio paese per ridurre l'impatto ambientale. Per lo smaltimento, rivolgersi ad un distributore o un affiliato presenti nel proprio paese.

Gli indirizzi sono elencati nel sito Web EIZO riportato di seguito.

www.eizoglobal.com

Per informazioni sul riciclaggio per i clienti in Svizzera, consultare il sito Web riportato di seguito.

www.swico.ch

Återvinningsinformation

När denna produkt kasseras ska den hanteras och återvinnas enligt landets föreskrifter för att reducera miljöpåverkan.

När du kasserar produkten ska du kontakta en distributör eller representant i ditt land.

Kontaktadresserna listas på EIZO-webbplatsen nedan.

www.eizoglobal.com

Πληροφορίες ανακύκλωσης

Το προϊόν αυτό, όταν απορρίπτεται, πρέπει να συλλέγεται και να ανακυκλώνεται σύμφωνα με τη νομοθεσία της χώρας σας έτσι ώστε να μην επιβαρύνει το περιβάλλον. Για να απορρίψετε το προϊόν, επικοινωνήστε με έναν αντιπρόσωπο ή μια θυγατρική εταιρεία στη χώρα σας.

Οι διευθύνσεις επικοινωνίας αναγράφονται στην τοποθεσία web της EIZO παρακάτω.

www.eizoglobal.com

Сведения по утилизации

По истечении срока службы данного продукта его следует принести на сборный пункт и утилизировать в соответствии с действующими предписаниями в вашей стране, чтобы уменьшить вредное воздействие на окружающую среду. Прежде чем выбросить данный продукт, обратитесь к дистрибьютору или в местное представительство компании в вашей стране.

Контактные адреса можно найти на веб-узле EIZO.

www.eizoglobal.com

Informatie over recycling

Wanneer u dit product wilt weggooien, moet het uit milieu-overwegingen worden verzameld en gerecycled volgens de betreffende wetgeving van uw land. Wanneer u dit product wilt weggooien, moet u contact opnemen met een distributeur of een partner in uw land.

De contactadressen worden vermeld op de volgende EIZO-website.

www.eizoglobal.com

Informação sobre reciclagem

Este produto, quando o deitar fora, deve ser recolhido e reciclado de acordo com a legislação do seu país para reduzir a poluição. Quando deitar fora este produto, contacte um distribuidor ou uma filial no seu país.

Os endereços de contacto estão listados no website do EIZO, abaixo.

www.eizoglobal.com

Oplysninger om genbrug

Dette produkt forventes ved bortskaffelse at blive indsamlet og genbrugt i overensstemmelse med lovgivningen i dit land for at reducere belastningen af miljøet. Når du bortskaffer denne produkt, skal du kontakte en distributør eller et tilknyttet selskab i dit land.

Adresserne på kontaktpersonerne er angivet på EIZO's websted nedenfor.

www.eizoglobal.com

Kierrätystä koskevia tietoja

Tuote tulee hävittää kierrättämällä maan lainsäädännön mukaisesti ympäristön kuormittumisen vähentämiseksi. Kun hävität tuotteen, ota yhteyttä jälleenmyyjään tai tytäryhtiöön maassasi.

Yhteystiedot löytyvät EIZOn Internet-sivustolta.

www.eizoglobal.com

Wykorzystanie surowców wtórnych

Ten produkt po zużyciu powinien być zbierany i przetwarzany zgodnie z krajowymi przepisami dotyczącymi ochrony środowiska. Wyrzucając ten produkt, należy skontaktować się z lokalnym dystrybutorem lub partnerem. Adresy kontaktowe można znaleźć we wskazanej poniżej witrynie internetowej firmy EIZO.

www.eizoglobal.com

Informace o recyklaci

Při likvidaci produktu musí být produkt vyzvednut a recyklován podle zákonů příslušné země, aby nedocházelo k zatěžování životního prostředí. Zbavujete-li se produktu, kontaktujte distributora nebo pobočku ve své zemi. Kontaktní adresy jsou uvedeny na následující webové stránce společnosti EIZO.

www.eizoglobal.com

Ringlussevõtu alane teave

Keskkonnakoormuse vähendamiseks tuleks kasutatud tooted kokku koguda ja võtta ringlusse vastavalt teie riigi seadustele. Kui kõrvaldate käesoleva toote, võtke palun ühendust turustaja või filiaaliga oma riigis.

Kontaktisikud on toodud EIZO veebilehel järgmisel aadressil:

www.eizoglobal.com

Újrahasznosítási információ

Jelen terméket, amikor eldobjuk, az illető ország törvényei alapján kell összegyűjteni és újrahasznosítani, hogy csökkentjük a környezet terhelését. Amikor ezt a terméket eldobja, kérjük lépjen kapcsolatba egy országon belüli forgalmazóval vagy társvállalkozással.

A kapcsolat címei az EIZO alábbi weboldalán található felsorolva:

www.eizoglobal.com

Podatki o recikliranju

Ob koncu uporabe odslužen izdelek izročite na zbirno mesto za recikliranje v skladu z okoljevarstveno zakonodajo vaše države. Prosimo, da se pri odstranjevanju izdelka obrnete na lokalnega distributerja ali podružnico.

Kontaktni naslovi so objavljeni na spodaj navedenih spletnih straneh EIZO:

www.eizoglobal.com

Informácie o recyklácii

Pri likvidácii musí byť tento výrobok recyklovaný v súlade s legislatívou vašej krajiny, aby sa znížilo zaťaženie životného prostredia. Keď sa chcete zbaviť tohto výrobku, kontaktujte prosím distribútora alebo pobočku vo vašej krajine.

Zoznam kontaktných adries je uvedený na nasledovnej webovej stránke firmy EIZO:

www.eizoglobal.com

Pārstrādes informācija

Utilizējot šo produktu, tā savākšana un pārstrāde veicama atbilstoši jūsu valsts likumdošanas prasībām attiecībā uz slodzes uz vidi samazināšanu. Lai veiktu šī produkta utilizāciju, sazinieties ar izplatītāju vai pārstāvniecību jūsu valstī. Kontaktadresses ir norādītas zemāk minētajā EIZO tīmekļa vietnē.

www.eizoglobal.com

Informacija apie gražinamąjį perdirbimą

Šalinant (išmetant) šiuos gaminius juos reikia surinkti ir perdirbti gražinamuoju būdu pagal jūsų šalies teisės aktus, siekiant sumažinti aplinkos teršimą. Kai reikia išmesti šį gaminį, kreipkitės į jūsų šalyje veikiančią gaminių pardavimo atstovybę arba jos filialą.

Kontaktiniai adresatai nurodyti EIZO interneto svetainėje.

www.eizoglobal.com

Информация относительно рециклиране

При изхвърлянето на този продукт се предлага събирането и рециклирането му съобразно законите на вашата страна за да се намали замърсяването на околната среда. Когато искате да се освободите от този продукт, моля свържете се с търговския му представител или със съответните органи отговарящи за това във вашата страна.

Данните за връзка с нас са описани на следния Интернет сайт на EIZO:

www.eizoglobal.com

Informație referitoare la reciclare

Acest produs, când debarasat, trebuie colectat și reciclat conform legislației țării respective ca să reducem sarcina mediului. Când se debarasează de acest produs, vă rugăm să contactați un distribuitor sau un afiliat al țării respective.

Adresele de contact le găsiți pe pagina de web al EIZO:

www.eizoglobal.com

معلومات عن اعادة التدوير

عند التخلص من هذا المنتج، من الضروري تجميعه واعادة تدويره وفقاً للقوانين المتبعة في بلدك لتقليل العبء المسلط على البيئة. عندما تتخلص من هذا المنتج، يرجى الاتصال بموزع أو طرف منتسب إليه في بلدك. عناوين الاتصال مدرجة في موقع ايزو EIZO ادناه على شبكة الانترنت.

www.eizoglobal.com

Gerı Dönüşüm Bilgisi

Bu ürünün, atılacağı zaman, ülkenizin çevre kirliliğinin azaltılması konusundaki mevzuatına göre toplanması ve yeniden değerlendirilmesi gerekmektedir. Ürünü atacağınız zaman lütfen ülkenizdeki bir distribütör veya ilgili kuruluşla temasa geçiniz.

İrtibat adresleri aşağıdaki EIZO web sitesinde verilmiştir.

www.eizoglobal.com



EIZO Corporation



153 Shimokashiwano, Hakusan, Ishikawa 924-8566 Japan

EIZO Europe GmbH

Helmut-Grashoff-Strasse 18, 41179 Mönchengladbach, Germany

www.eizoglobal.com

Copyright © 2020 EIZO Corporation. All rights reserved.

00N0N109A1 
UM-FDS1703-A-2 

1st Edition-April, 2020 Printed in Japan.