



# Installation Manual

## RadiForce® MS236WT-A

**Color LCD Monitor with Touch Panel**

### **Important**

**To ensure that the product is used correctly, carefully read through this Installation Manual and the Instructions for Use before use.**

- See the Instructions for Use for monitor installation and connection.
- You can check the latest product information, including the Installation Manual, from our web site.  
[www.eizoglobal.com](http://www.eizoglobal.com)

This product has been adjusted specifically for use in the region to which it was originally shipped.  
If operated outside this region, the product may not perform as stated in the specifications.

---

No part of this manual may be reproduced, stored in a retrieval system, or transmitted, in any form or by any means, electronic, mechanical, or otherwise, without the prior written permission of EIZO Corporation.

EIZO Corporation is under no obligation to hold any submitted material or information confidential unless prior arrangements are made pursuant to EIZO Corporation's receipt of said information. Although every effort has been made to ensure that this manual provides up-to-date information, please note that EIZO product specifications are subject to change without notice.

---

# CONTENTS

<b>1 Basic Adjustment / Settings</b> .....	<b>4</b>
1.1 Enabling / Disabling the Touch Panel .....	4
1.2 Adjusting Touch Sensitivity .....	5
1.3 Switching Input Signals .....	5
1.4 Adjusting Brightness .....	6
1.5 Adjusting Volume .....	6
<b>2 Touch Panel Settings</b> .....	<b>7</b>
2.1 Setting Up the Touch Panel .....	7
2.2 Set Touch Panel Operations .....	8
<b>3 Advanced Adjustments/Settings</b> .....	<b>9</b>
3.1 Basic Operation of the Setting Menu .....	9
3.2 Setting Menu Functions .....	10
3.2.1 Color .....	10
3.2.2 Signal .....	13
3.2.3 Preferences.....	16
3.2.4 Languages .....	17
3.2.5 Information .....	17
<b>4 Administrator Settings</b> .....	<b>18</b>
4.1 Basic Operation of the "Administrator Settings" Menu .....	18
4.2 Functions of the "Administrator Settings" Menu .....	18
<b>5 Troubleshooting</b> .....	<b>20</b>
5.1 No Picture .....	20
5.2 Imaging Problems (Digital and Analog).....	21
5.3 Imaging Problems (Analog only).....	22
5.4 Touch Panel Problems .....	22
5.5 Other Problems .....	24
<b>6 Reference</b> .....	<b>26</b>
6.1 Arm Installation Procedure .....	26
6.2 Connecting Multiple PCs .....	28
6.3 Using the USB Hub Function .....	29
6.4 Default settings for Color Mode .....	30
<b>Appendix</b> .....	<b>31</b>
Trademark .....	31
License .....	31
LIMITED WARRANTY .....	31

# 1 Basic Adjustment / Settings

## 1.1 Enabling / Disabling the Touch Panel

You can switch between enabling and disabling the touch panel. You can use this when you want to temporarily disable the touch panel function.

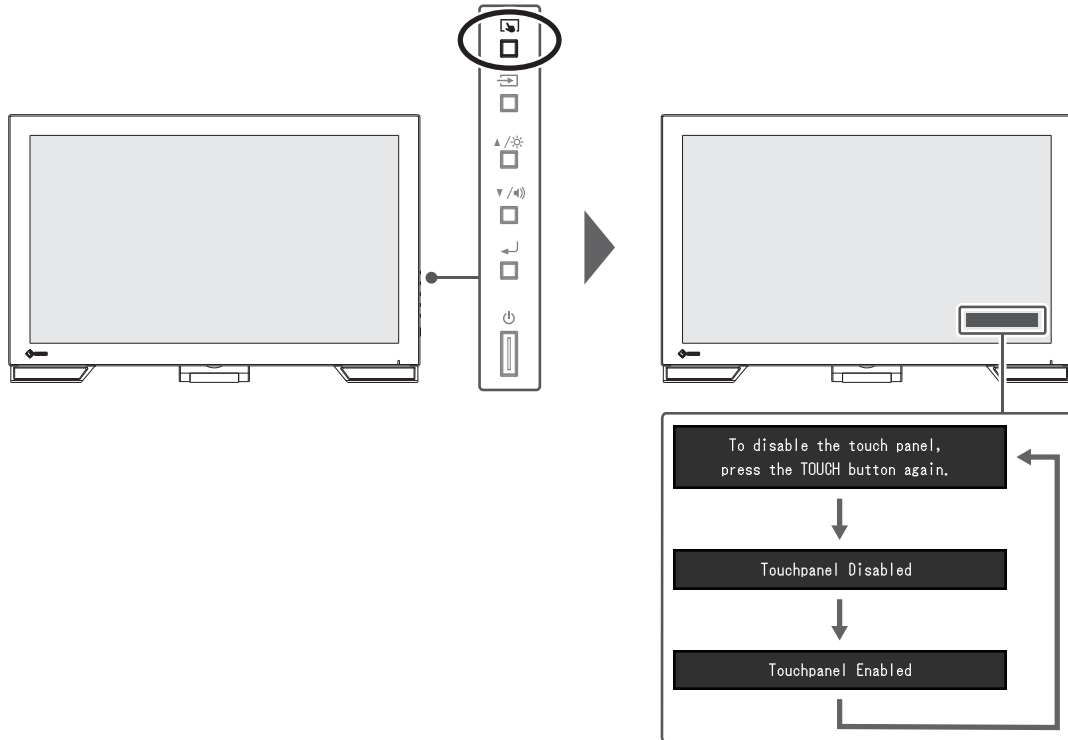

### 1.2 Adjusting Touch Sensitivity

Holding down  allows you to adjust (calibrate) the touch sensitivity. You make adjustments if you are having problems with touch operations.

<b>Note</b>
<ul style="list-style-type: none"><li>• Please make sure to run TPOffset after setting up the monitor.</li><li>• Execute TPOffset if the problem is not improved after adjusting touch sensitivity (see "Touch Panel Setup" in the Instructions for Use).</li></ul>

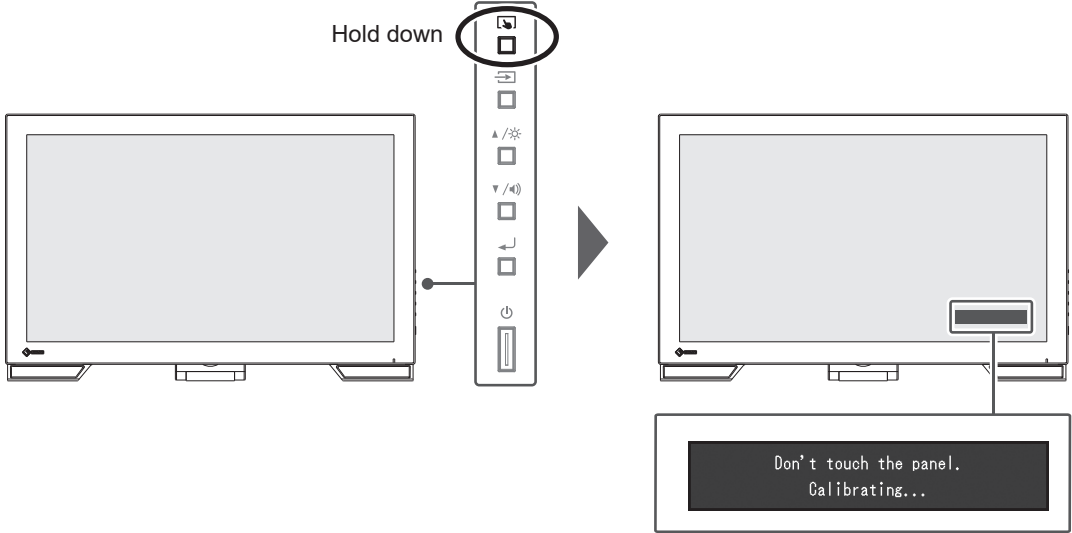

### 1.3 Switching Input Signals

When a monitor has multiple signal inputs, the signal to display on-screen can be changed. The selected input port name is displayed on the top right of the screen.

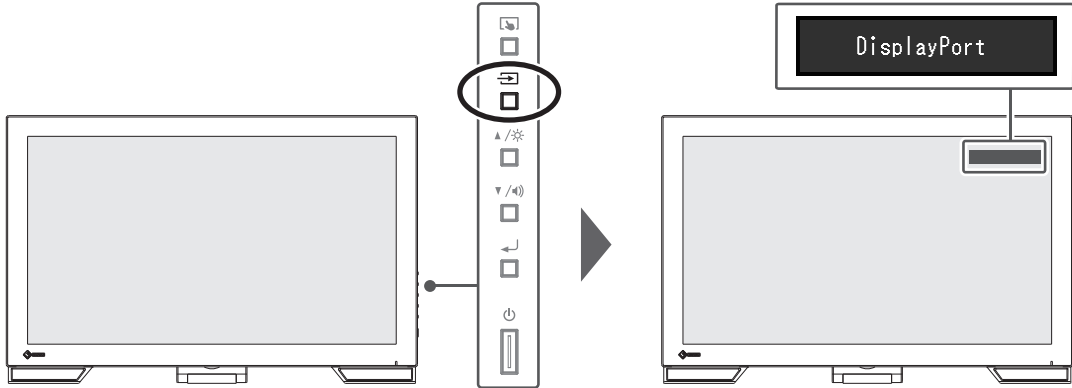

## 1.4 Adjusting Brightness

Settings: "0" – "100"

The brightness of the screen can be adjusted to suit the installation environment or personal preference.

The screen brightness is adjusted by changing the brightness of the backlight (light source from the LCD back panel).

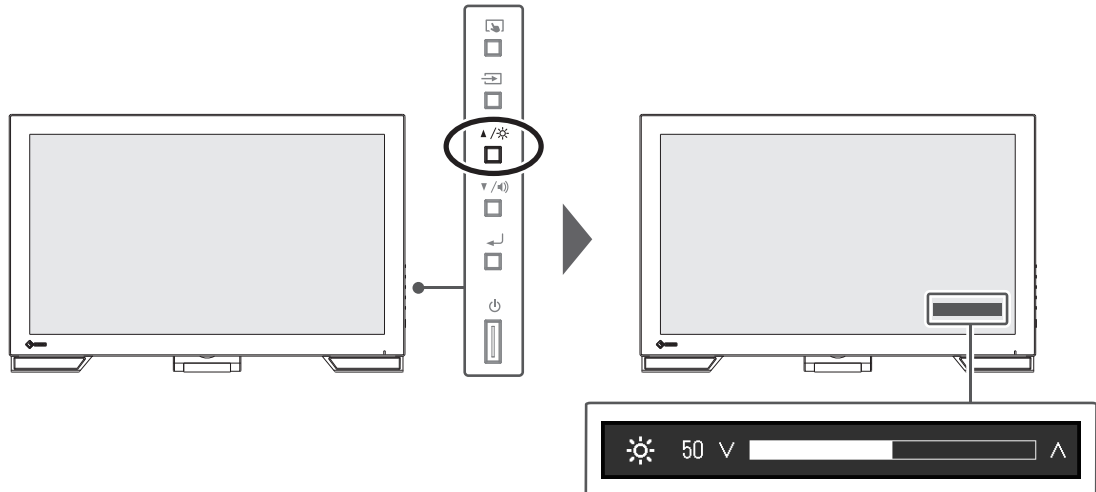

## 1.5 Adjusting Volume

Settings: "0" – "30"

The volume of the speakers can be set individually.

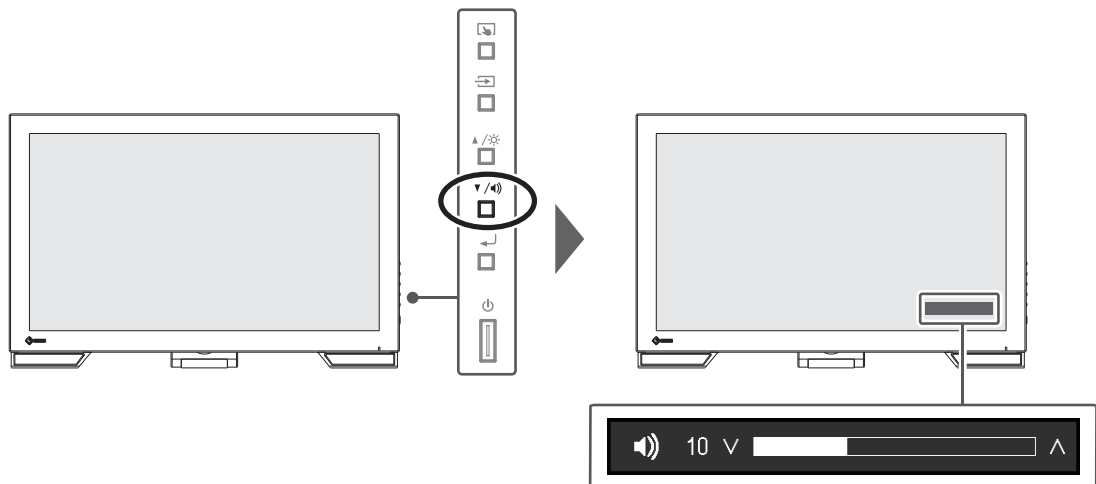

## 2 Touch Panel Settings

### 2.1 Setting Up the Touch Panel

The touch panel functions of this product differ according to the driver used and the driver setup. Set it according to your application.

Function	Windows standard driver	Dedicated touch panel driver (DMT-DD) <sup>*1</sup>	
Driver installation	Not required	Required	
Touch sound output	×	✓	
Multiple connections <sup>*2</sup>	✓ <sup>*3</sup>	✓	
Operation mode	Touch digitizer <sup>*4</sup>	Touch digitizer <sup>*4*5</sup>	Mouse emulation <sup>*5</sup>
Multi-Touch operation	✓	✓	×

\*1 Included in the EIZO LCD Utility Disk (CD-ROM).

\*2 Two or more of this monitor can be connected to a PC

\*3 Windows 11 / Windows 10 only

\*4 Touch operations may not be recognized in applications designed using mouse emulation.

\*5 For more information about the setup procedure, refer to the Touch Panel Driver User's Manual (on the CD-ROM).

#### Note

- When the settings are completed, run the TPOffset software included in the CD-ROM, and adjust the sensitivity of the touch panel.

If using a Windows standard driver, see the following for the settings.

## 2.2 Set Touch Panel Operations

1. Open the Windows control panel.  
How to open differs depending on the operating system.

### Windows 11

From the start menu, select "All apps" - "Windows Tools" - "Control Panel".

### Windows 10

From the start menu, select "All Apps" - "Windows System" - "Control Panel".

### Windows 8.1

Click  at the bottom of the "Start" screen. The "App" screen appears.

In "Windows System", click "Control Panel".

2. Click "Hardware and Sound" - "Pen and Touch".  
The "Pen and Touch" screen appears.

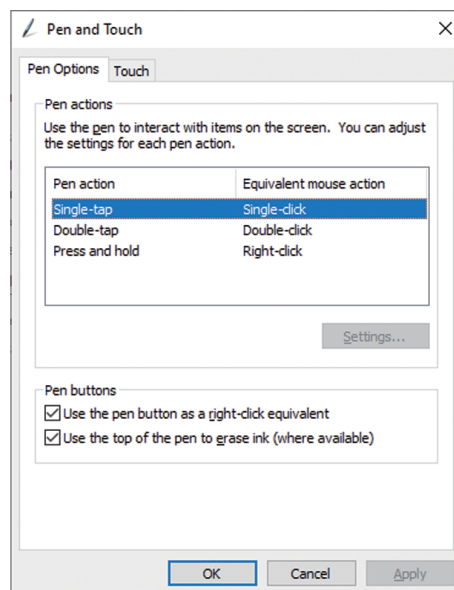

Configure the touch panel operation settings in the "Pen and Touch" screen. For more details about the settings, see each setting screen and Windows help.

3. When you have completed the settings, click "OK" to close the screen.

## 3 Advanced Adjustments/Settings

This chapter describes the advanced monitor adjustment and setting procedures using the Setting menu.

For basic functions, see [3 Advanced Adjustments/Settings \[▶ 9\]](#).

### 3.1 Basic Operation of the Setting Menu

1. Press  $\leftarrow$ .  
The Setting menu appears.

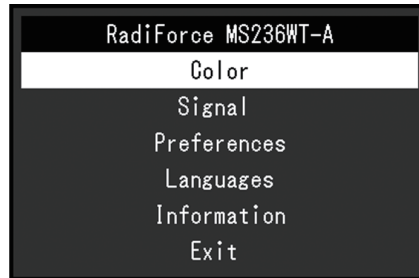

2. Select the menu to adjust/set with  $\blacktriangle$   $\blacktriangledown$ , then press  $\leftarrow$ .  
The Sub menu appears.

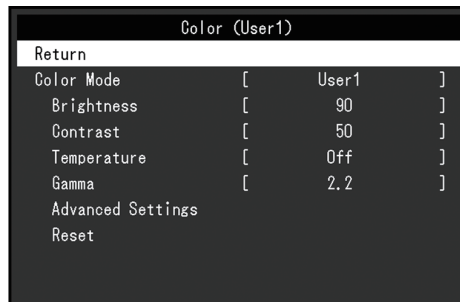

3. Select the menu to adjust/set with  $\blacktriangle$   $\blacktriangledown$ , then press  $\leftarrow$ .  
The Adjustment/Setting menu appears.



4. Perform adjustment/setting with  $\blacktriangle$   $\blacktriangledown$ , then press  $\leftarrow$ .  
The Sub menu appears.
5. Select "Return" in the Sub menu, then press  $\leftarrow$ .  
The Setting menu appears.
6. Select "Exit" in the Setting menu, then press  $\leftarrow$ .  
The Setting menu exits.

#### Note

- Quickly pressing  $\leftarrow$  twice in a row will also exit the Setting menu.

## 3.2 Setting Menu Functions

### 3.2.1 Color

The color mode settings can be adjusted according to personal preference. The adjusted settings are saved for each color mode.

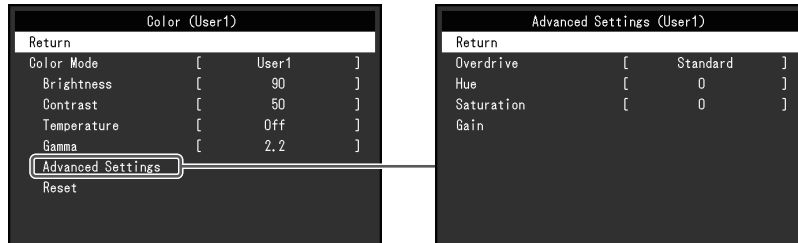

Functions that can be adjusted differ depending on the color mode.

√: Adjustable, -: Not adjustable

Function		Color Mode		
		User1 User2	sRGB	DICOM
Brightness		√	√	-
Contrast		√	-	-
Temperature		√	-	-
Gamma		√	-	-
Advanced Settings	Overdrive	√	-	-
	Hue	√	-	-
	Saturation	√	-	-
	Gain	√	-	-
Reset		√	√	-

#### Attention

- It takes about 30 minutes for the monitor display to stabilize. Please wait 30 minutes or more after power to the monitor has been turned on before adjusting the monitor.
- The same image may be observed in different colors on multiple monitors due to monitor-specific characteristics. Make fine color adjustments visually when matching colors across multiple monitors. Follow the procedure below to adjust and match colors across multiple monitors.
  1. Display a white screen on each monitor.
  2. Use one of the monitors as a visual reference point to make adjustments to "Brightness", "Temperature", and "Gain" of the other monitors.

#### Color Mode

Settings: "User1" / "User2" / "sRGB" / "DICOM"

Select the desired mode according to the monitor application.

The color mode settings can also be adjusted according to personal preference. Select the color mode for adjustment and perform adjustment using the relevant functions.

**Note**

- The adjustment status of each mode is as follows:
  - User 1, User 2: Select either of these modes to set a user-defined display mode.
  - sRGB: Suitable for color matching with sRGB compatible peripherals.
  - DICOM: Select this mode to simply display digital imaging for medical based on DICOM® Part 14 (Not intended for diagnostic purposes).

**Brightness**

Settings: "0" – "100"

The screen brightness is adjusted by changing the brightness of the backlight (light source from the LCD back panel).

**Note**

- If the image is too dark even when the brightness is set to 100, adjust the contrast.

**Contrast**

Settings: "0" – "100"

The brightness of the screen is adjusted by varying the video signal level.

**Note**

- A contrast of 50 displays every color gradation.
- When adjusting the monitor, it is recommended to perform brightness adjustment, which does not lose gradation characteristics, prior to contrast adjustment.
- Perform contrast adjustment in the following cases:
  - If the image is too dark even when the brightness is set to 100 (Set the contrast to higher than 50.)

**Temperature**

Settings: "Off" / "4000 K" – "10000 K (in increments of 500 K. 9300 K is included.)"

Adjusts the color temperature.

The color temperature is normally used to express the hue of "White" and/or "Black" with a numerical value. The value is expressed in degrees "K" (Kelvin).

The screen becomes reddish at low color temperatures and bluish at high color temperatures, similar to the temperatures of a flame. A gain preset value is set for each color temperature setting value.

**Note**

- The value shown in "K" is available only as a reference.
- "Gain" allows you to perform more advanced adjustment (see [Advanced Settings - Gain](#) [▶ 12]).
- If set to "Off", the image is displayed in the preset color of the LCD panel (Gain: 100 for each RGB channel).
- When the gain is changed, the color temperature setting changes to "Off".

**Gamma**

Settings: "1.8" / "2.0" / "2.2" / "2.4"

Adjusts the gamma.

While the brightness of the monitor varies depending on the video level of the input signal, the variation rate is not directly proportional to the input signal. Maintaining the balance between the input signal and brightness of the monitor is referred to as "Gamma correction".

**Note**

- If "sRGB" is selected for the color mode, "sRGB" is displayed for the gamma value.
- If "DICOM" is selected for the color mode, "DICOM" is displayed for the gamma value.

**Advanced Settings - Overdrive**

Settings: "Enhanced" / "Standard" / "Off"

This function allows you to set the overdrive intensity based on the use of the monitor. Image lag can be reduced by using the "Enhanced" setting when displaying moving images.

**Note**

- Depending on the display resolution and the setting of "[Picture Expansion \[▶ 13\]](#)", overdrive may be set to "Off".

**Advanced Settings - Hue**

Settings: "-50" – "50"

Adjusts the hue.

**Note**

- Using this function may prevent some color gradations from being able to be displayed.

**Advanced Settings - Saturation**

Settings: "-50" – "50"

Adjusts the color saturation.

**Note**

- Using this function may prevent some color gradations from being able to be displayed.
- The minimum value (-50) changes the screen to monochrome.

**Advanced Settings - Gain**

Settings: "0" – "100"

The brightness of each red, green, and blue color component is referred to as "Gain". The hue of "white" can be changed by adjusting the gain.

**Note**

- Using this function may prevent some color gradations from being able to be displayed.
- The gain value changes according to the color temperature.
- When the gain is changed, the color temperature setting changes to "Off".

**Reset**

Resets any color adjustments for the currently selected color mode back to the default settings.

### 3.2.2 Signal

Set the details regarding input signal, such as the screen size and color format.

- D-Sub input



- HDMI/DisplayPort™ input

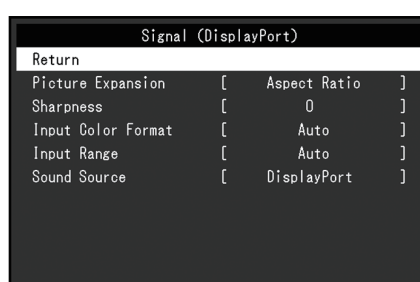

The functions that can be set differ depending on the input signal.

√: Can be set, -: Cannot be set.

Function	Input Signal		
	DisplayPort	HDMI	D-SUB
Picture Expansion	√	√	√
Sharpness	√	√	√
Input Color Format	√	√	-
Input Range	√	√	-
Source	√	√	-
Analog Adjustment	-	-	√

#### Picture Expansion

Settings: "Auto"<sup>\*1</sup> / "Full Screen" / "Aspect Ratio" / "Dot by Dot"

\*1 Only enabled during HDMI input

The screen size of the monitor display can be changed.

- "Auto"
 

The monitor automatically changes the screen size according to the aspect ratio and resolution information from the PC.
- "Full Screen"
 

Images are stretched to full screen. Since aspect ratios are not maintained, images may be distorted in some cases.
- "Aspect Ratio"
 

Images are enlarged to full screen without changing the aspect ratio. Since aspect ratios are maintained, blank horizontal or vertical borders may appear.
- "Dot by Dot"
 

Displays the image at the set resolution or size specified by the input signal.

**Note**

- Setting example

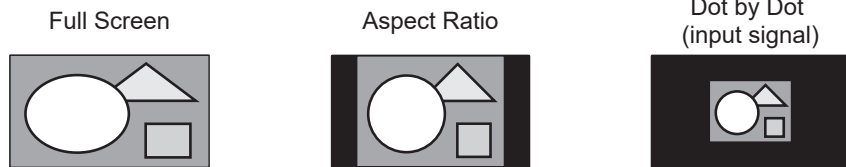
**Sharpness**

Settings: "-2" – "2"

When a low-resolution image is displayed using picture expansion mode ("Full Screen" or "Aspect Ratio"), the text and lines of the image may appear blurry. This blurriness can be reduced by configuring the settings for sharpness.

**Note**

- For some display resolutions, it is not necessary to configure the settings for sharpness. ("Sharpness" is not a value that can be selected.)

**Input Color Format**

Settings: "Auto" / "YUV 4:2:2<sup>\*1</sup>" / "YUV 4:4:4<sup>\*1</sup>" / "YUV<sup>\*2</sup>" / "RGB"

The color format of the input signal can be specified.

Try changing this setting if colors are not displayed correctly.

\*1 Only enabled during HDMI input

\*2 Only enabled during DisplayPort input

**Input Range**

Settings: "Auto" / "Full" / "Limited"

Depending on the video reproduction device, there may be a restriction on black and white video signal levels output to the monitor. This kind of signal is called "Limited range". On the other hand, unlimited signals are called "Full range".

- "Auto"  
Input signal brightness range is automatically judged and is displayed appropriately (recommended setting). Depending on the video reproduction device, Limited range and Full range may not be able to be judged by the monitor. In such a case, selecting "Full" or "Limited" will allow it to be displayed appropriately.
- "Full"  
To be selected in case of Full range signals. Appropriate display can be obtained when this is selected, in case both blacks and whites are corrupted.
- "Limited"  
To be selected in case of Limited range signals. In case this is selected, the output signal range is expanded from 0 to 255 to obtain an appropriate display when black is pale and white is dull.

**Note**

- When "YUV" is selected in "Input Color Format", the setting is automatically set to "Limited". Additionally, when "Auto" is selected and the monitor determines the input color format to be YUV, the setting is automatically set to "Limited".

### Sound Source

Settings: "Stereo Mini Jack" / "HDMI<sup>\*1</sup>" / "DisplayPort<sup>\*2</sup>"

You can switch the sound source for HDMI® signal input or DisplayPort signal input.

\*1 Only enabled during HDMI input

\*2 Only enabled during DisplayPort input

#### Note

- For HDMI signal input and D-Sub signal input that do not include audio signals, the setting is fixed as "Stereo Mini Jack".

### Analog Adjustment - Auto Screen Adjust

Screen flicker, display position and size and be automatically adjusted. When you select "Auto Screen Adjust", a message will appear. Select "Yes".

#### Note

- The automatic screen adjustment function will operate correctly if an image is displayed in the entire displayable area of the screen. It will not operate correctly in the following cases:
  - When an image is displayed in only part of a screen like the command prompt
  - When black is used in the background, such as a wallpaper
 Also, when the function may not work correctly in part of the graphics board
- When a signal is input to the monitor for the first time, or when the resolution or horizontal/vertical scan frequency is changed to one that had not been displayed before, it is automatically adjusted (signals with a resolution of 800 x 600 (SVGA) or above).

### Analog Adjustment - Auto Range Adjust

The signal output level can be automatically adjusted to enable display of all color gradations (0 to 255). When you select "Auto Range Adjust", a message will appear. Select "Yes".

### Analog Adjustment - Clock

Flickering of vertical lines or part of the screen can be minimized.

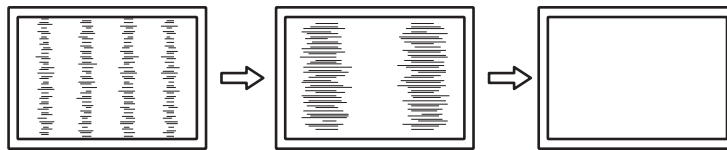

#### Note

- It is easy to overlook the point where the setting is suitable, so please finely adjust.

### Analog Adjustment - Phase

Flickering or bleeding of the screen as a whole can be minimized.

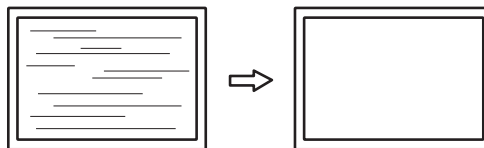

**Note**

- Flickering or bleeding may not fully disappear, depending on the PC and graphics board you are using.
- If vertical stripes appear on the screen after completing the setting, adjust "Clock" again.

**Analog Adjustment - Hor. Position / Ver. Position**

The display position (horizontal, vertical) of the screen can be adjusted.

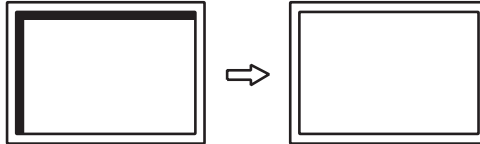
**Note**

- The number of pixels and the pixel positions of the LCD monitor are fixed, so there is one correct display position for images. Position adjustment is for adjusting an image to the correct position.

**3.2.3 Preferences**

The monitor's settings can be configured to suit the usage environment or personal preference.

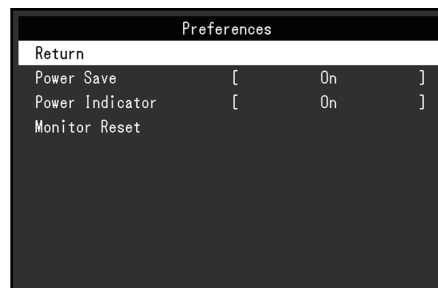

**Power Save**

Settings: "On" / "Off"

The monitor can be set to enter power saving mode according to the state of the PC.

The monitor changes to power saving mode about 15 seconds after signal input ceases to be detected.

When the monitor has shifted to power saving mode, images are not displayed on the screen and audio is not output.

- How to exit power saving mode
  - Press the  button or  button.
  - The monitor automatically exits power saving mode when the monitor receives input

**Note**

- At the time of shifting to power saving mode, a message that indicates the transition is displayed five seconds in advance.
- When not using the monitor, you can turn off the main power supply or disconnect the power plug so that the power is cut completely.
- When [Compatibility Mode \[▶ 19\]](#) is set to "On", even if the monitor shifts to power saving mode, devices connected to the USB downstream port are operational. Therefore, power consumption of the monitor varies with connected devices even in power saving mode.

**Power Indicator**

Settings: "On" / "Off"

The power indicator (blue) can be turned off in normal operation mode.

**Monitor Reset**

Restores all settings to their default settings except for the following settings:

- Settings on the "Administrator Settings" menu
- Enabling/disabling the touch panel

**3.2.4 Languages**

Settings: "English" / "German" / "French" / "Spanish" / "Italian" / "Swedish" / "Japanese" / "Simplified Chinese" / "Traditional Chinese"

The display language for menus and messages can be selected.

**Attention**

- The display language of the "Administrator Settings" menu (English) cannot be changed.

**3.2.5 Information**

You can check the monitor information (model name, serial number (S/N), firmware version, usage time) and the input signal information.

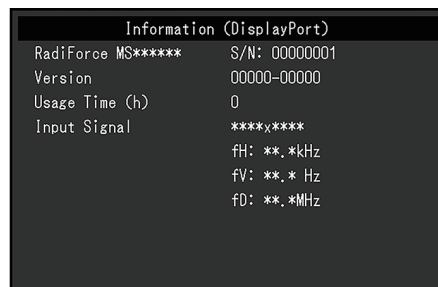

Example:







## 4 Administrator Settings

This chapter describes how to configure monitor operation using the "Administrator Settings" menu.

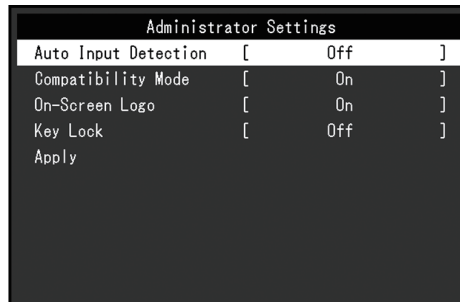



### 4.1 Basic Operation of the "Administrator Settings" Menu

1. Press  to turn the monitor off .
2. Holding down  and pressing  for more than 2 seconds will turn on the monitor.  
The "Administrator Settings" menu appears.

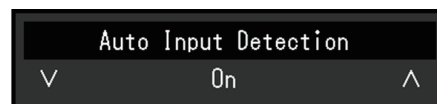

3. Select an item to set with   then press .
- The Adjustment/Setting menu appears.



4. Set with  , then press .
  5. Select "Apply" then press .
- The settings are applied and the "Administrator Settings" menu exits.

#### Attention

- The language (English) of the "Administrator Settings" menu cannot be changed.

### 4.2 Functions of the "Administrator Settings" Menu

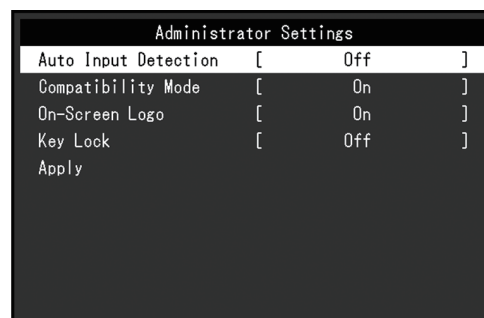

#### Auto Input Detection

Settings: "On" / "Off"

This function automatically recognizes the connector through which PC signals are input, and displays images on the screen accordingly.

- "On"  
When the monitor is connected to multiple PCs, if a specific PC enters power saving mode or no signals are input to the monitor, the connector is automatically changed to another one to which signals are input.
- "Off"  
To be set to this when manually selecting input signals. Select the input signal to display using the operation switch (  ) on the front of the monitor. For details, see [1.3 Switching Input Signals \[▶ 5\]](#).

**Note**

- This product automatically recognizes the connector through which PC signals are input, and displays images on the screen accordingly regardless of whether this function is set to On or Off just after the main power switch on the back of the monitor has been turned on.
- When this function is set to "On", the monitor only enters the power saving mode when signals are not input from any PC.

**Compatibility Mode**

Settings: "On" / "Off"

If you want to avoid the following phenomena, set this function to "On":

- The positions of windows and icons are shifted when the monitor is turned off/on or has returned from the power saving mode.
- Even when the mouse or keyboard are used, the PC does not return from sleep.
- When the power to the monitor is turned off, a device connected to the USB downstream port does not work, or power is not supplied to the connected device.

**On-Screen Logo**

Settings: "On" / "Off"

When the monitor is turned on, the logo appears on the screen.

When this function is set to "Off", the logo does not appear.

**Key Lock**

Settings: "Off" / "Menu" / "All"

In order to prevent changes to settings, the operation buttons on the rear of the monitor can be locked.

- "Off" (default setting)  
Enables all buttons.
- "Menu"  
Locks the  button.
- "All"  
Locks all buttons except the power button.

## 5 Troubleshooting

### 5.1 No Picture

#### Power switch indicator does not light up

- Check whether the power cord is connected properly.
- Turn the main power switch on.
- Press .
- Turn off the main power, and then turn it on again a few minutes later.

#### Power switch indicator lights up: Blue

- Increase "Brightness", "Contrast", or "Gain" in the Setting menu (see [Color \[▶ 10\]](#)).

#### Power switch indicator lights up: Orange

- Use  to switch the input signal.
- Turn the setting "On" for "Compatibility Mode" in the "Administrator Settings" menu (see [Compatibility Mode \[▶ 19\]](#)).
- Move the mouse or press any key on the keyboard.
- Touch the touch panel.
- Check whether the PC is turned on.
- Turn off the main power, and then turn it on again.

#### The message "No Signal" appears on the screen

Example:

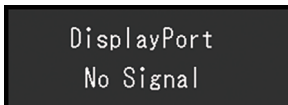

- The message shown above may appear as some PCs do not output the signal immediately after power-on.
- Check whether the PC is turned on.
- Check whether the signal cable is connected properly. Connect the signal cables to the connectors of the corresponding input signal.
- Use  to try switching the input signal.
- Turn off the main power, and then turn it on again.
- Try setting "Auto Input Detection" in the "Administrator Settings" menu to "Off" and switching the input signal manually (see [Auto Input Detection \[▶ 18\]](#)).

#### The message "Signal Error" appears on the screen

Example:

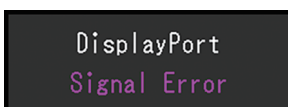

- Check whether the PC is configured to meet the resolution and vertical scan frequency requirements of the monitor (see "Compatible Resolutions" in the Instructions for Use).

- Reboot the PC.
- Select an appropriate setting using the graphics board's utility. Refer to the User's Manual of the graphics board for details.

## 5.2 Imaging Problems (Digital and Analog)

### The screen is too bright or too dark

- Use "Brightness" or "Contrast" in the Setting menu to adjust it (see [Color ▶ 10](#)). (The LCD monitor backlight has a limited life span. If the screen becomes dark or begins to flicker, contact your local EIZO representative.)

### Letters and images are blurred

- Check whether the PC is configured to meet the resolution and vertical scan frequency requirements of the monitor (see "Compatible Resolutions" in the Instructions for Use).
- Try setting the magnification of display on the OS to "100 %". When using multiple monitors, try setting the magnification of display to "100 %" on all monitors.

### Afterimage visible

- Afterimages are particular to LCD monitors. Avoid displaying the same image for a long time.
- Use the screen saver or power saving function to avoid displaying the same image for extended periods of time.
- Depending on the image, an afterimage may appear even if it was displayed for a short period of time. To remove such a phenomenon, change the image or keep the power turned off for several hours.

### Green / red / blue / white / dark dots remain on the screen

- This is due to LCD panel characteristics and not a malfunction.

### Interference patterns or pressure marks remain on the LCD panel

- Leave the monitor with a white or black screen. The symptom may disappear.

### Noise appears on the screen

- In the Setting menu, set "Overdrive" to "Off" (see [Advanced Settings - Overdrive ▶ 12](#)).
- When inputting HDCP system signals, normal images may not be displayed immediately.

### The positions of windows and icons are shifted when the monitor is turned off/on or when restored from power saving mode

- Turn the setting "On" for "Compatibility Mode" in the "Administrator Settings" menu (see [Compatibility Mode ▶ 19](#)).

### The color shown on the screen is not correct

- Try changing "Input Color Format" in the Setting menu (see [Input Color Format ▶ 14](#)).

### Images are not displayed over the entire area of the screen

- Try changing "Picture Expansion" in the Setting menu (see [Picture Expansion ▶ 13](#)).

- Check whether the setting for the resolution of the PC matches the resolution of the monitor.

### **Fog remains even after wiping the screen / Condensation inside the glass**

- If fog remains even after wiping the screen, there may be condensation on the inside of the protective glass on the LCD panel. Wait a while for the condensation to disappear. Even if condensation occurs on the inside of the glass in this manner, it does not cause malfunction or deterioration of the product.

## **5.3 Imaging Problems (Analog only)**

### **Screen is misaligned**

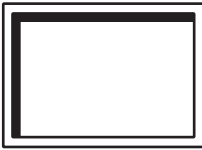

- Use "Hor. Position" or "Ver. Position" in the Setting menu to adjust the positioning of the screen (see [Analog Adjustment - Hor. Position / Ver. Position \[▶ 16\]](#)).
- If the graphics board's utility has a function to change the position of the image, use that function to adjust the position.

### **Vertical lines appear on the screen / Part of the screen is flickering**



- Try adjusting "Clock" in the Setting menu (see [Analog Adjustment - Clock \[▶ 15\]](#)).



### **The whole screen appears to flicker or bleed**



- Try adjusting "Phase" in the Setting menu (see [Analog Adjustment - Phase \[▶ 15\]](#)).

## **5.4 Touch Panel Problems**

### **Touch operations do not work**

- Check that the monitor and PC are connected with a USB cable.
- Press  (see [1.1 Enabling / Disabling the Touch Panel \[▶ 4\]](#)).
- Check that the power cords of the monitor and PC are connected to a grounded main outlet. Failure to ground the equipment may result in malfunction.
- Hold  (see [1.2 Adjusting Touch Sensitivity \[▶ 5\]](#)).
- Execute TPOffset to adjust the touch panel sensitivity.

### **The touch and cursor positions are misaligned / The cursor jumps**

- Connect the monitor and PC via the supplied cable. The touch panel may not work correctly if a conversion adapter is used.
- Turn off the monitor, and then turn it on again.
- If you are using a dedicated touch panel driver, see the User Manual of the touch panel driver and perform software calibration.
- Check that the power cords of the monitor and PC are connected to a grounded main outlet. Failure to ground the equipment may result in malfunction.
- Hold  (see [1.2 Adjusting Touch Sensitivity \[▶ 5\]](#)).
- Changing the position or angle of the monitor may cause the cursor to jump.
- Using metals near the touch panel screen may cause the cursor position to become misaligned.
- The monitor may malfunction if the touch panel is dirty. Clean the touch panel surface (see "How to Cleaning" in the Instructions for Use).
- Using a spray for preventing static electricity may influence the sensitivity of the touch panel, causing the cursor position to become misaligned.
- Do not touch the touch panel for 5 seconds after the PC starts up, after turning on the monitor, or after connecting the USB cable. Touching the touch panel too soon may cause incorrect cursor positioning or disable touch operation. If this occurs, turn the monitor off, and then turn it on again.
- Execute TPOffset to adjust the touch panel sensitivity.
- Set the "Picture Expansion" setting to "Full Screen."
- When displaying at a resolution other than the recommended resolution, the touch position and cursor position may become misaligned due to the scaling function of the graphics board. Check the settings of the graphics driver and change the display scaling from the graphics driver to the monitor.

### **The cursor is not displayed at the touch position, but is displayed in the center of the monitor**

- If you are using a dedicated touch panel driver, see the User Manual of the touch panel driver and perform software calibration.

### **Cursor shakes / Drawing lines are unstable**

- Check if grounding on the power cord for the monitor and PC is connected to ground. If not connected to ground, this may result in malfunction.
- Run TPOffset and try adjusting the sensitivity of the touch panel.
- A metal object may affect the stability of the cursor.
- If multiple monitors are positioned close to each other, position them further apart.

### **Touch panel correction does not function correctly**

- If you are using a dedicated touch panel driver, refer to the Touch Panel Driver User's Manual.

### **Touch sounds do not work**

- If you are using a Windows standard driver, touch sounds will not work. To use touch sounds, use a dedicated touch panel driver (see [2.1 Setting Up the Touch Panel \[▶ 7\]](#)).

### **Multi-touch does not work**

- Reboot the PC.
- If you are using a dedicated touch panel driver, refer to the Touch Panel Driver User's Manual.

## **5.5 Other Problems**

### **The Setting menu does not appear**

- Check whether the operation switch lock function is active (see [Key Lock \[▶ 19\]](#)).

### **Cannot select items in the Setting menu**

- Items that are displayed with gray text cannot be changed.
- "Color" items cannot be changed in some color modes. Setting the color mode to "User 1" or "User 2" will allow you to change all items (see [Color \[▶ 10\]](#)).

### **No audio output**

- Check whether the volume is set to "0".
- Check the PC and audio playback software to see whether they are configured correctly.
- When using DisplayPort input and HDMI input, check the "Sound Source" settings (see [Sound Source \[▶ 15\]](#)).
- When using D-Sub input, check if the stereo mini jack cable (commercially available product) is connected.

### **USB peripheral devices connected to the monitor do not work**

- Check whether the USB cable is correctly connected between the PC and the monitor.
- Check whether the USB cable is correctly connected between the peripheral and the monitor.
- Try using a different USB port on the monitor.
- Try using a different USB port on the PC.
- Update the USB drivers for peripheral devices.
- Reboot the PC.
- When "Compatibility Mode" is set to "Off" in the "Administrator Settings" menu and the power of the monitor is turned off, devices connected to the USB downstream port are not operational. Change the setting for "Compatibility Mode" to "On" (see [Compatibility Mode \[▶ 19\]](#)).
- If the peripheral devices work correctly when they are directly connected to the PC, contact your local EIZO representative.
- Check the PC's BIOS setting for USB when using Windows. (Refer to the User's Manual of the PC for details.)
- Update the PC OS.

### **Power indicator is flashing orange**

- This symptom may occur when the PC is connected to the DisplayPort connector. Use a signal cable recommended by us for the connection. Turn the monitor off and on.

- Check the connection and condition of the USB peripheral devices connected to the monitor.
- Turn off the main power switch on the back of the monitor, and then turn it on again.

**Even when the mouse or keyboard are used, the PC does not return from sleep**

- Turn the setting "On" for "Compatibility Mode" in the "Administrator Settings" menu (see [Compatibility Mode \[▶ 19\]](#)).

## 6 Reference

### 6.1 Arm Installation Procedure

An optional arm (or an optional stand) can be attached by removing the stand section. Please refer to our website for supported optional arms (or optional stands).

([www.eizoglobal.com](http://www.eizoglobal.com))

When attaching an arm or stand, the installable orientations and movement range (tilt angle) are as follows:

- Orientation

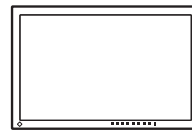
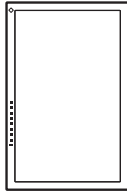

- Movement range (tilt angle)

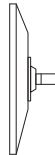

Up: 0°

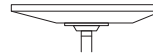

Up: 90°

#### Attention

- When attaching an arm or stand, follow the instructions of the respective User's Manual.
- When using another manufacturer's arm or stand, confirm the following in advance with the manufacturer and select one conforming to the VESA standard.
  - Clearance between screw holes: 100 mm x 100 mm
  - Plate thickness: 2.6 mm
  - Strong enough to support weight of the monitor unit (excluding the stand) and attachments such as cables
- When using another manufacturer's arm or stand, use the following screws to secure it.
  - Screws fixing the stand to the monitor
- Connect the cables after attaching an arm or stand.
- The monitor, arm, and stand are heavy. Dropping them may result in injury or equipment damage.
- Check periodically that the screws are tight enough. If the screws are not tight enough, the monitor may come unattached. This may be the cause of injury or damage.

1. Lay the LCD monitor on a soft cloth spread over a stable and flat surface with the LCD panel surface facing down.
2. Remove the stand.  
Using a screwdriver, remove the screws securing the unit and the stand.

3. Attach the arm or stand to the monitor.  
Use the screws specified in the arm or stand User's Manual for installation.

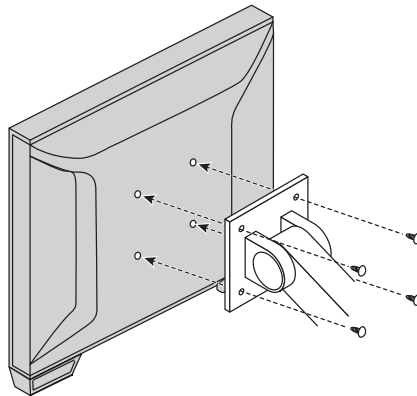
**Note**

- To install vertically, use the following procedure to remove the leg from underneath the monitor.

1. Remove the leg cover.

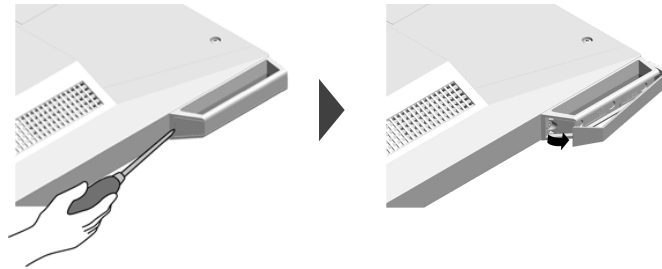

2. Remove the screws securing the unit and feet.

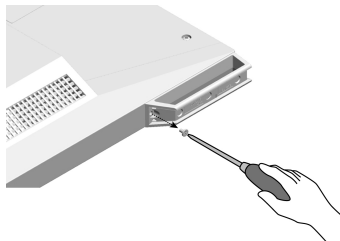

3. Slide the feet toward the outer side of the monitor to remove, as shown in the drawing below. You can cover the screw holes with screw cover sheets.



- Please store the removed parts carefully.

## 6.2 Connecting Multiple PCs

This product can be connected to multiple PCs and allows you to switch between the connections for display.

### Connection Examples

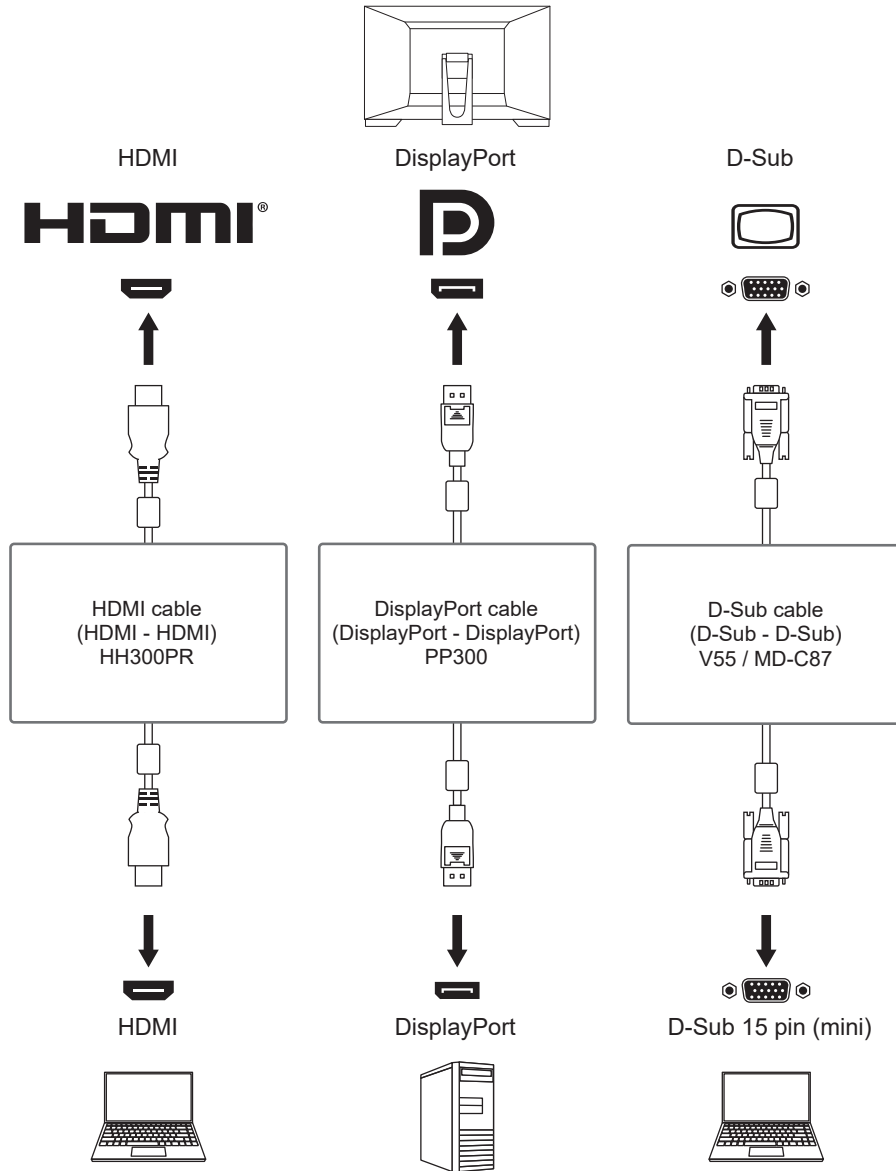

#### Attention

- The touch panel only operates for a USB-connected monitor.

**Note**

- You can select the input signal to display using the  operation button on the rear of the monitor. For details, see [1.3 Switching Input Signals](#) [▶ 5].
- This product provides a function that automatically recognizes the connector through which PC signals are input, and displays images on the screen accordingly. For details, see [Auto Input Detection](#) [▶ 18].

## 6.3 Using the USB Hub Function

This monitor is equipped with a USB hub. It functions as a USB hub when connected to a USB-compatible PC, allowing the connection of peripheral USB devices.

1. Connect the USB cable.
2. If necessary, connect a mouse, keyboard, or other device to the USB downstream port.

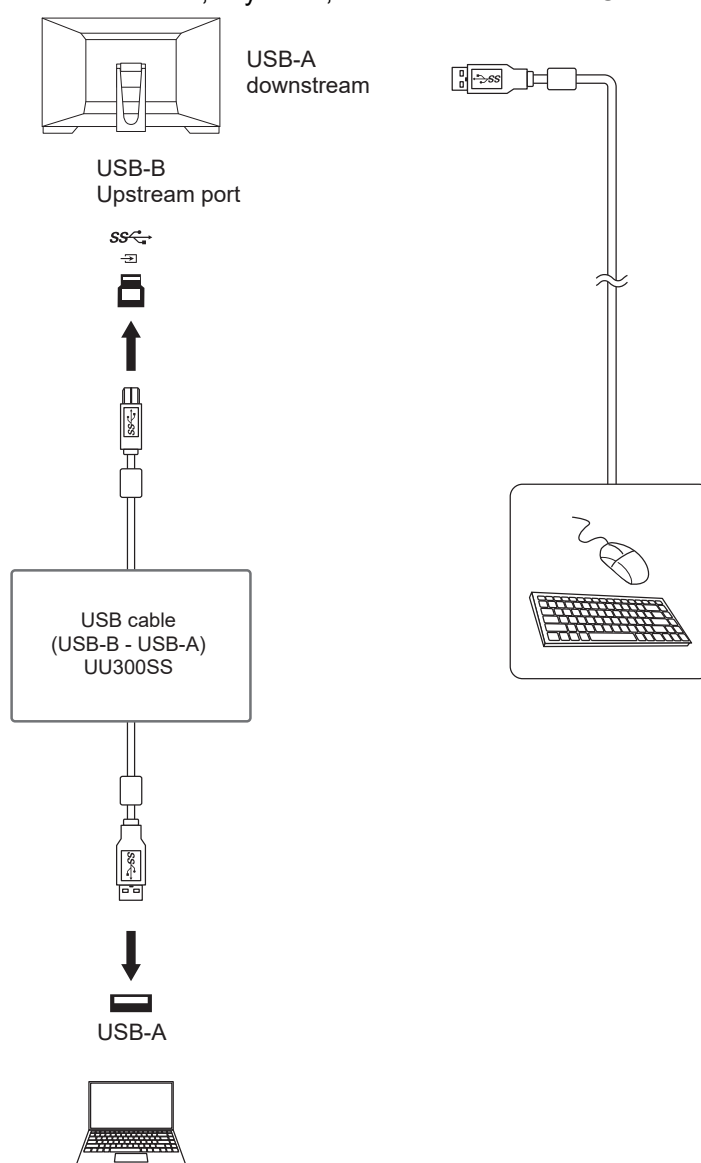

**Attention**

- This function may not work depending on the PC you are using, your OS, and your peripheral devices. Contact the manufacturer of each device for information about USB compatibility.
- Even when the monitor is in power saving mode, devices connected to the USB downstream port are operational. Due to this, the power consumption of the monitor varies depending on the connected devices, even in power saving mode.
- When the main power switch of the monitor is off, a device connected to the USB downstream port will not operate.
- When "[Compatibility Mode \[▶ 19\]](#)" is set to "Off" and the monitor is turned off, devices connected to the USB downstream port are not operational.

**Note**

- This product supports USB 5Gbps. When connecting to peripheral devices that support USB 5Gbps, high-speed data communication is possible.

## 6.4 Default settings for Color Mode

Mode	Brightness	Temperature	Gamma
User1	Approx. 265 cd/m <sup>2</sup>	Off	2.2
User2	Approx. 265 cd/m <sup>2</sup>	Off	2.2
sRGB	Approx. 265 cd/m <sup>2</sup>	6500 K	2.2
DICOM	180 cd/m <sup>2</sup>	7500 K	DICOM GSDF

## Appendix

### Trademark

The terms HDMI and HDMI High-Definition Multimedia Interface, and the HDMI Logo are trademarks or registered trademarks of HDMI Licensing, LLC in the United States and other countries.

The DisplayPort Compliance Logo and VESA are registered trademarks of the Video Electronics Standards Association.

The SuperSpeed USB Trident Logo is a registered trademark of USB Implementers Forum, Inc.



The SuperSpeed USB Power Delivery Trident Logos are trademarks of USB Implementers Forum, Inc.



USB Type-C and USB-C are registered trademarks of USB Implementers Forum, Inc.

DICOM is the registered trademark of the National Electrical Manufacturers Association for its standards publications relating to digital communications of medical information.

Kensington and Microsaver are registered trademarks of ACCO Brands Corporation.

Thunderbolt is a trademark of Intel Corporation in the United States and/or other countries.

Microsoft and Windows are registered trademarks of Microsoft Corporation in the United States and other countries.

Adobe is a registered trademark of Adobe in the United States and other countries.

Apple, macOS, Mac OS, OS X, macOS Sierra, Macintosh, and ColorSync are registered trademarks of Apple Inc.

ENERGY STAR is a registered trademark of the United States Environmental Protection Agency in the United States and other countries.

EIZO, the EIZO Logo, ColorEdge, CuratOR, DuraVision, FlexScan, FORIS, RadiCS, RadiForce, RadiNET, Raptor, and ScreenManager are registered trademarks of EIZO Corporation in Japan and other countries.

ColorEdge Tablet Controller, ColorNavigator, EcoView NET, EIZO EasyPIX, EIZO Monitor Configurator, EIZO ScreenSlicer, G-Ignition, i•Sound, Quick Color Match, RadiLight, Re/Vue, SafeGuard, Screen Administrator, Screen InStyle, ScreenCleaner, SwitchLink, and UniColor Pro are trademarks of EIZO Corporation.

All other company names, product names, and logos are trademarks or registered trademarks of their respective owners.

### License

The bitmap font used for this product is designed by Ricoh Industrial Solutions Inc.

### LIMITED WARRANTY

EIZO Corporation (hereinafter referred to as “EIZO”) and distributors authorized by EIZO (hereinafter referred to as the “Distributors”) warrant, subject to and in accordance with the terms of this limited warranty (hereinafter referred to as the “Warranty”), to the original purchaser (hereinafter referred to as the “Original Purchaser”) who purchased the product specified in this document (hereinafter referred to as the “Product”) from EIZO or Distributors, that EIZO and Distributors shall, at their sole discretion, either repair or replace

the Product at no charge if the Original Purchaser becomes aware within the Warranty Period (defined below) that the Product malfunctions or is damaged in the course of normal use of the Product in accordance with the description in the instruction manual of the Product (hereinafter referred to as the "User's Manual").

The period of this Warranty is three (3) years from the date of purchase of the Product (hereinafter referred to as the "Warranty Period").

EIZO and Distributors shall bear no liability or obligation with regard to the Product in relation to the Original Purchaser or any third parties other than as provided under this Warranty.

EIZO and Distributors will cease to hold or store any parts (excluding design parts) of the Product upon expiration of seven (7) years after the production of the Product is discontinued.

In repairing the Product, EIZO and Distributors will use renewal parts which comply with our QC standards. If the unit cannot be repaired due to its condition or the stockout of a relevant part, EIZO and Distributors may offer the replacement by a product with equivalent performance instead of repairing it.

The Warranty is valid only in the countries or territories where the Distributors are located. The Warranty does not restrict any legal rights of the Original Purchaser.

Notwithstanding any other provision of this Warranty, EIZO and Distributors shall have no obligation under this Warranty whatsoever in any of the cases as set forth below:

1. Any defect of the Product caused by freight damage, modification, alteration, abuse, misuse, accident, incorrect installation, disaster, adherent dust, faulty maintenance and/or improper repair by third party other than EIZO and Distributors;
2. Any incompatibility of the Product due to possible technical innovations and/or regulations;
3. Any deterioration of the sensor, including measurement value of the sensor;
4. Any defect of the Product caused by external equipments;
5. Any defect of the Product caused by the use under environmental conditions not anticipated by EIZO;
6. Any deterioration of the attachments of the Product (e.g. cables, User's Manual, CD-ROM, etc.);
7. Any deterioration of the consumables, and/or accessories of the Product (e.g. batteries, remote controller, touch pen, etc.);
8. Any exterior deterioration or discoloration of the Product, including that of the surface of the LCD panel, the touch panel and the protect panel;
9. Any defect of the Product caused by placement in a location where it may be affected by strong vibrations or shocks;
10. Any defect of the Product caused by leaking battery liquid;
11. Any deterioration of display performance caused by the deterioration of expendable parts such as the LCD panel and/or backlight, etc. (e.g. changes in brightness, changes in brightness uniformity, changes in color, changes in color uniformity, defects in pixels including burnt pixels, etc.);
12. Any deterioration or malfunction of the cooling fan caused by adherent dust.

To obtain service under the Warranty, the Original Purchaser must deliver the Product, freight prepaid, in its original package or other adequate package affording an equal degree of protection, assuming the risk of damage and/or loss in transit, to the local Distributor. The Original Purchaser must present proof of purchase of the Product and the date of such purchase when requesting services under the Warranty.

The Warranty Period for any replaced and/or repaired product under this Warranty shall expire at the end of the original Warranty Period.

EIZO OR DISTRIBUTORS ARE NOT RESPONSIBLE FOR ANY DAMAGE TO, OR LOSS OF, DATA OR OTHER INFORMATION STORED IN ANY MEDIA OR ANY PART OF ANY PRODUCT RETURNED TO EIZO OR DISTRIBUTORS FOR REPAIR.

EIZO AND DISTRIBUTORS MAKE NO FURTHER WARRANTIES, EXPRESSED OR IMPLIED, WITH RESPECT TO, INCLUDING, WITHOUT LIMITATION, THE PRODUCT AND ITS QUALITY, PERFORMANCE, MERCHANTABILITY OR FITNESS FOR ANY PARTICULAR USE.

IN NO EVENT SHALL EIZO OR DISTRIBUTORS BE LIABLE FOR ANY INCIDENTAL, INDIRECT, SPECIAL, CONSEQUENTIAL OR OTHER DAMAGE WHATSOEVER (INCLUDING, WITHOUT LIMITATION, DAMAGES FOR LOSS OF PROFIT, BUSINESS INTERRUPTION, LOSS OF BUSINESS INFORMATION, OR ANY OTHER PECUNIARY LOSS) ARISING OUT OF THE USE OR INABILITY TO USE THE PRODUCT OR IN ANY CONNECTION WITH THE PRODUCT, WHETHER BASED ON CONTRACT, TORT, NEGLIGENCE, STRICT LIABILITY OR OTHERWISE, EVEN IF EIZO OR DISTRIBUTORS HAVE BEEN ADVISED OF THE POSSIBILITY OF SUCH DAMAGES.

THIS EXCLUSION ALSO INCLUDES ANY LIABILITY WHICH MAY ARISE OUT OF THIRD PARTY CLAIMS AGAINST THE ORIGINAL PURCHASER. THE ESSENCE OF THIS PROVISION IS TO LIMIT THE POTENTIAL LIABILITY OF EIZO AND DISTRIBUTORS ARISING OUT OF THIS LIMITED WARRANTY AND/OR SALES.

