

User's Manual

ColorEdge[®] CS230 CX240

Calibration Color LCD Monitor

Important

Please read PRECAUTIONS, this User's Manual, and the Setup Guide (separate volume) carefully to familiarize yourself with safe and effective usage.

-
- Please refer to the Setup Guide for basic information ranging from connection of the monitor to a PC to using the monitor.
 - The latest User's Manual is available for download from our web site: <http://www.eizoglobal.com>
-



Location of Caution Statement

Ex. CS230

WARNING
RISK OF ELECTRIC SHOCK. DO NOT OPEN.
AVERTISSEMENT
RISQUE DE CHOC ELECTRIQUE. NE PAS OUVRIR.
WARNUNG
GEFAHR DES ELEKTRISCHEN SCHLAGES. RÜCKWAND NICHT ENTFERNEN.
警告
触电危険、請勿打开后盖。
警告
感電の恐れあり、カバーをあけないでください。
The equipment must be connected to a grounded main outlet.
L'appareil doit être relié à une prise avec terre.
Jordet stikkontakt skal benyttes når apparatet tilkobles datanett.
Apparaten skall anslutas till jordat nätuttag.
设备必须连接到接地的电源插座。
電源コードのアースは必ず接地してください。

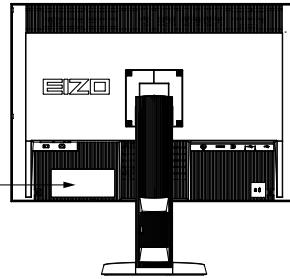

This product has been adjusted specifically for use in the region to which it was originally shipped. If operated outside this region, the product may not perform as stated in the specifications.

No part of this manual may be reproduced, stored in a retrieval system, or transmitted, in any form or by any means, electronic, mechanical, or otherwise, without the prior written permission of EIZO Corporation.

EIZO Corporation is under no obligation to hold any submitted material or information confidential unless prior arrangements are made pursuant to EIZO Corporation's receipt of said information. Although every effort has been made to ensure that this manual provides up-to-date information, please note that EIZO monitor specifications are subject to change without notice.

Notice for this monitor

Aside from general purposes like creating documents, viewing multimedia content, this product is also suited to applications such as creations of images and graphics, and digital photo processing, where accurate color reproduction is a priority.

This product has been adjusted specifically for use in the region to which it was originally shipped. If the product is used outside the region, it may not operate as specified in the specifications.

This product may not be covered by warranty for uses other than those described in this manual.

The specifications noted in this manual are only applicable when the following are used:

- Power cords provided with the product
 - Signal cables specified by us
-

Only use optional products manufactured or specified by us with this product.

If you place this product on a lacquer-coated desk, the color may adhere to the bottom of the stand due to the composition of the rubber. Check the desk surface before use.

As it takes about 30 minutes (CS230) / 7 minutes (CS240: under our measurement conditions) for the performance of electrical parts to stabilize. Please wait 30 minutes (CS230) / 7 minutes (CX240) or more after the monitor power has been turned on, and then adjust the monitor.

Monitors should be set to a lower brightness to reduce changes in luminosity caused by long-term use and maintain a stable display.

When the screen image is changed after displaying the same image for extended periods of time, an afterimage may appear. Use the screen saver or power save function to avoid displaying the same image for extended periods of time.

Periodic cleaning is recommended to keep the monitor looking new and to prolong its operation lifetime (refer to [“Cleaning” \(page 4\)](#)).

The LCD panel is manufactured using high-precision technology. Although, missing pixels or lit pixels may appear on the LCD panel, this is not a malfunction. Percentage of effective dots: 99.9994% or higher.

The backlight of the LCD panel has a fixed lifetime. When the screen becomes dark or begins to flicker, please contact your local EIZO representative.

Do not press on the panel or edge of the frame strongly, as this may result in display malfunctions, such as interference patterns, etc. If pressure is continually applied to the panel, it may deteriorate or damage your panel. (If the pressure marks remain on the panel, leave the monitor with a black or white screen. The symptom may disappear.)

Do not scratch or press on the panel with any sharp objects, as this may result in damage to the panel. Do not attempt to brush with tissues as this may scratch the panel.

When the monitor is cold and brought into a room or the room temperature goes up quickly, dew condensation may occur on the interior and exterior surfaces of the monitor. In that case, do not turn the monitor on. Instead wait until the dew condensation disappears, otherwise it may cause some damage to the monitor.

Cleaning

Attention

- Chemicals such as alcohol and antiseptic solution may cause gloss variation, tarnishing, and fading of the cabinet or panel, and also quality deterioration of the image.
- Never use any thinner, benzene, wax, and abrasive cleaner, which may damage the cabinet or panel.

Note

- The optional ScreenCleaner is recommended for cleaning the cabinet and panel surface.

If necessary, the stains on the cabinet and panel surface can be removed by moistening part of a soft cloth with water.

To use the monitor comfortably

- An excessively dark or bright screen may affect your eyes. Adjust the brightness of the monitor according to the environmental conditions.
- Staring at the monitor for a long time tires your eyes. Take a 10-minute rest every hour.

CONTENTS

Notice for this monitor	3		
Cleaning	4		
To use the monitor comfortably	4		
CONTENTS	5		
Chapter 1 Introduction	7		
1-1. Features	7		
1-2. Controls and Functions	9		
1-3. EIZO LCD Utility Disk	10		
● Disk contents and software overview	10		
● To use ColorNavigator / ColorNavigator Elements	10		
1-4. Basic Operations and Functions	11		
● Basic Adjustment menu operations	11		
● Showing Button Guide	12		
● Functions	13		
Chapter 2 Adjusting Screens	15		
2-1. Compatible Resolutions	15		
● Analog Input (DVI-I)	15		
● Digital Input (DVI / DisplayPort)	15		
● Digital Input (HDMI)	15		
2-2. Setting the Resolution	16		
● Windows 10	16		
● Windows 8.1 / Windows 7	16		
● Windows Vista	16		
● Windows XP	16		
● OS X Mountain Lion (10.8) and later	17		
● Mac OS X 10.7	17		
2-3. Adjusting Color	18		
● To select the display mode (color mode)	18		
● To perform advanced adjustments	19		
● Adjustable settings in each mode	19		
● Adjusting Brightness	20		
● Adjusting the temperature	20		
● Adjusting Gamma	21		
● Adjusting Hue	21		
● Adjusting Saturation	22		
● To enable/disable Contrast Enhancer	22		
● To enhance outline of image	22		
● To set clipping	23		
● Adjusting Gain	24		
● Adjusting 6 Colors	24		
2-4. Adjusting Screens	25		
● Digital Signal Input	25		
● Analog Signal Input	25		
2-5. Expanding Signal Output Range	28		
2-6. Selecting Screen Size	29		
● DVI, DisplayPort signal input	29		
● HDMI (HD signal) input	30		
● HDMI (SD signal) input	31		
2-7. Configuring Moving Image Performance ...	31		
2-8. Specifying Color Space	32		
2-9. Setting HDMI	32		
● Reducing Noise	32		
Chapter 3 Setting Monitor	33		
3-1. Enabling/Disabling Mode Selection	33		
3-2. Selecting the Language	33		
3-3. Setting Orientation	33		
3-4. Changing Adjustment Menu Display Position	34		
3-5. Showing and Hiding the EIZO Logo	34		
3-6. Locking Operation Button	34		
3-7. Setting Signal Bandwidth	35		
3-8. Switching USB Port Automatically	35		
3-9. Changing DUE (Digital Uniformity Equalizer) Setting	36		
3-10. Reset to default	36		
● To reset the color adjustments	36		
● To reset all adjustments to the default settings	37		
Chapter 4 SelfCorrection	38		
4-1. Executing SelfCorrection	38		
Chapter 5 Power Saving Functions	39		
5-1. Setting Power Save	39		
5-2. Enabling/Disabling Automatic Brightness Adjustment	40		
5-3. Checking the Power Saving Level	40		
5-4. Adjusting the Brightness of Indicator	40		
5-5. Setting USB Power Save	41		
5-6. Setting DisplayPort Power Save	41		
Chapter 6 Troubleshooting	42		
6-1. No picture	42		
6-2. Imaging problems	43		
6-3. Other problems	44		
6-4. Built-in correction sensor and SelfCorrection problems	45		
Chapter 7 Reference	46		
7-1. Attaching the Optional Arm	46		
7-2. Connecting Multiple External Devices	47		
● To switch among input signals	48		
● To set input signal selection "Input Selection"	48		

7-3. Making Use of USB (Universal Serial Bus)	49
● System Requirement.....	49
● Procedure.....	49
7-4. Showing Monitor Information	50
● Displaying signal information “Signal Info” ...	50
● Displaying Monitor Information “Monitor Info”	50
7-5. Specifications	51
● CS230	51
● CX240	52
7-6. Preset Timing	55
7-7. Glossary	56
Appendix	58
Trademark	58
License	58
FCC Declaration of Conformity	59
LIMITED WARRANTY	60
Recycling Information	69

Chapter 1 Introduction

1-1. Features

- 23.0" wide format LCD (CS230)
- 24.1" wide format LCD (CX240)
- Wide color gamut (Adobe RGB coverage: 97%, CX240 only)
- Supports a resolution of 1920 × 1080 (CS230).
- Supports a resolution of 1920 × 1200 (CX240).
- IPS panel with 178° horizontal and vertical viewing angles
- Frame synchronization mode supported (23.75 - 30.5Hz, 47.5 - 61.0Hz)
- 3 signal input terminals (DVI-I × 1, HDMI × 1, DisplayPort × 1)
 - DisplayPort connector (applicable to 8 bit and 10 bit)*1
 - HDMI connector (applicable to 8 bit, 10 bit, and 12 bit)*1
- *1 Not applicable to audio signals.
- Color Mode function
 - Reproduces a color gamut and gamma compliant with the following standard.
 - Adobe®RGB (CX240 only)
 - The Paper mode reproduces a printed paper effect on the monitor.
 - See "To select the display mode (color mode)" (page 18).
- Supports portrait and landscape format (rotate 90° clockwise)
- This product is equipped with a built-in correction sensor, and supports SelfCorrection in which the monitor executes display correction independently.
 - See "Chapter 4 SelfCorrection" (page 38).
- The "ColorNavigator" Color Management Software enables you to calibrate monitor characteristics and generate color profiles*2
 - *2 The Color Management Software "ColorNavigator" is on the CD-ROM for the ColorNavigator Licensed models.
 - See "1-3. EIZO LCD Utility Disk" (page 10).
- Supports Photo Color Matching Software "ColorNavigator Elements"*3
 - This software enables you to adjust the color of the monitor easily while comparing it with a printed picture.
 - *3 Stored on the CD-ROM for the ColorNavigator non-licensed models. See "1-3. EIZO LCD Utility Disk" (page 10).
- The software "ScreenManager Pro for LCD" to adjust the screen using the mouse and keyboard is included.
 - This software can be downloaded from our web site (<http://www.eizoglobal.com>).
- Supports Color Vision Deficiency Simulation Software "UniColor Pro"
 - This software can be downloaded from our web site (<http://www.eizoglobal.com>).
- Power saving function
 - Suppressing the power consumption reduces the carbon dioxide emissions. This product is equipped with power saving function.
 - 0 W power consumption when the main power is off
 - Equipped with main power switch.
 - When the monitor is not required, the power supply can be shut off using the main power switch.
 - Auto EcoView function
 - The ambient light sensor on the front side of the monitor detects the environmental brightness to adjust the screen brightness automatically and comfortably. Excessively high brightness may increase power consumption and cause unwanted environmental effects. It may also lead to fatigue of your eyes. Use the Auto EcoView to reduce the brightness.
 - See "5-2. Enabling/Disabling Automatic Brightness Adjustment" (page 40).
- Displays HDCP (High-bandwidth Digital Protection) protected contents.

Attention

Be careful of the following points when using the built-in correction sensor.



Do not touch the built-in correction sensor.

It may reduce the measurement accuracy of the built-in correction sensor, or result in injury or equipment damage.

Attention

- A high temperature or high humidity environment may affect the measurement accuracy of the built-in correction sensor. We suggest storing and using the monitor under the following conditions.
 - Temperature 30°C or less
 - Humidity 70% or lessAvoid storing or using the sensor where it may be exposed to direct sunlight.
-

Note

- This monitor supports both portrait and landscape format. You can change the orientation of the Setting menu when using the monitor screen in vertical display position. (see “[3-3. Setting Orientation](#)” (page 33))
 - When using the monitor screen in a portrait position, the graphics board supporting portrait display is required. When placing the monitor in a portrait position, the settings of your graphics board need to be changed. Refer to the User’s Manual of the graphics board for details.
-

1-2. Controls and Functions

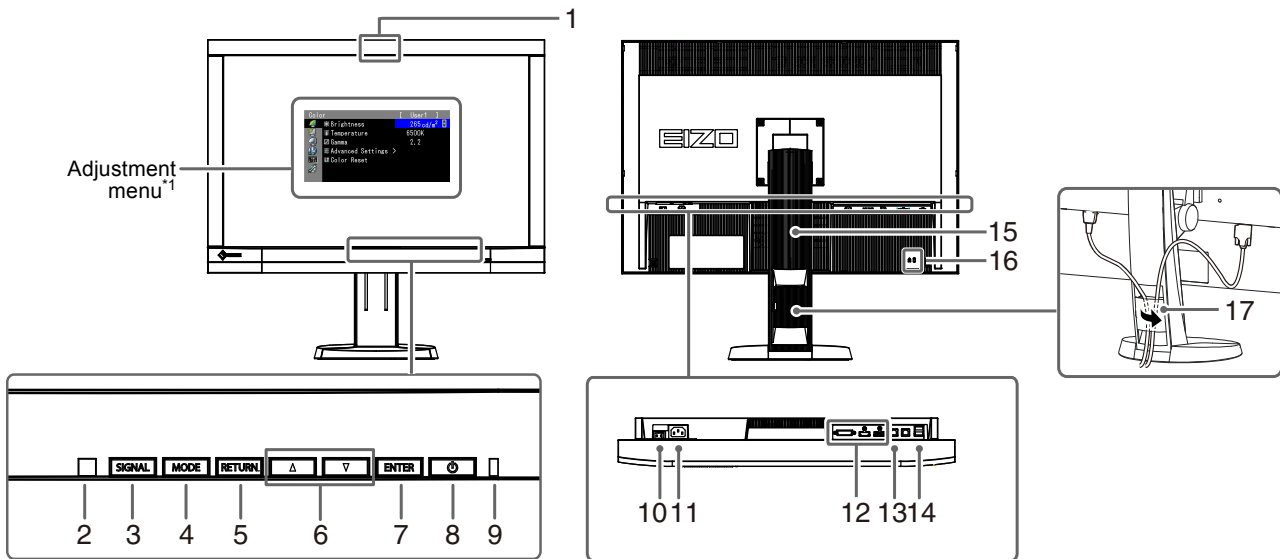

1. Built-in correction sensor	Executes display correction for an independent monitor. SelfCorrection function (page 38)
2. Ambient Light Sensor	Measures ambient light.
3. SIGNAL button	Switches input signals for display (page 48).
4. MODE button	Changes Color Mode (page 18).
5. RETURN button	Cancels the setting/adjustment and exits the Adjustment menu.
6. ▲▼ button	<ul style="list-style-type: none"> Provides the menu selection as well as the adjustment and setting of a function. Displays the Brightness menu (page 20).
7. ENTER button	Displays the Adjustment menu, determines an item on the menu screen, and saves values adjusted (page 11).
8. Power button	Turns the power on or off.
9. Power Indicator	<p>Indicates the monitor's operation status.</p> <p>Blue: Operating</p> <p>Flashing blue (2 times for each): In the following cases, this notifies that display re-correction is required.</p> <ul style="list-style-type: none"> When the timer is set in ColorNavigator (CAL mode) When the SelfCorrection schedule is set <p>Orange: Power saving mode</p> <p>OFF: Main power/Power off</p>
10. Main power switch	Turns the main power on or off.
11. Power connector	Connects the power cord.
12. Input signal connectors	Left: DVI-I connector / Center: HDMI connector / Right: DisplayPort connector
13. USB upstream port	<p>Connects the USB cable to use the software that needs USB connection, or to use USB hub function (page 49).</p> <p>Attention</p> <ul style="list-style-type: none"> By default, USB upstream port 1 is enabled. Connect the cable to USB upstream port 1 first.
14. USB downstream port	Connects a peripheral USB device.
15. Stand*2	Used to adjust the height and angle of the monitor screen.
16. Security lock slot	Complies with Kensington's MicroSaver security system.
17. Cable holder	Covers the monitor cables.

*1 For details, see "1-4. Basic Operations and Functions" (page 11).

*2 An optional arm (or an optional stand) can be attached by removing the stand section (see "7-1. Attaching the Optional Arm" (page 46)).

1-3. EIZO LCD Utility Disk

An “EIZO LCD Utility Disk” (CD-ROM) is supplied with this product. The following table shows the disk contents and the overview of the software programs.

● Disk contents and software overview

The disk includes application software programs for adjustment, and User’s Manual. Refer to “Readme.txt” or the “read me” file on the disk for software startup procedures or file access procedures.

Contents	Overview	Windows	Macintosh
A “Readme.txt” or “read me” file			
ColorNavigator* ¹	Software for calibrating monitor characteristics and generating ICC profiles (for Windows) and Apple ColorSync profiles (for Macintosh). (A PC must be connected to the monitor with the supplied USB cable.)	√	√
ColorNavigator Elements* ²	Software for adjusting the color and brightness of the monitor while comparing a picture displayed on the monitor with a printed picture. (A PC must be connected to the monitor with the supplied USB cable.)	√	√
Screen adjustment pattern files	Used when adjusting the image of the analog signal input manually.	√	-
User’s Manual of this monitor (PDF file)			

*1 Only ColorNavigator Licensed models

*2 Only ColorNavigator Non-Licensed models

● To use ColorNavigator / ColorNavigator Elements

The method of displaying the defined color gamut outside the normal gamut of the monitor can be set.

Attention

- If “ColorNavigator License” in the monitor information screen is “Not Registered”, the ColorNavigator license must be purchased and registered to the monitor. For the purchase of the license, contact your local EIZO representative.
- ColorNavigator Elements can be used without a license.

Refer to the corresponding User’s Manual on the CD-ROM disk in order to install and use the software. When using this software, you will need to connect a PC to the monitor with the supplied USB cable. For details of the USB cable connection, see “7-3. Making Use of USB (Universal Serial Bus)” (page 49).

1-4. Basic Operations and Functions

● Basic Adjustment menu operations

1. Displaying Adjustment Menu

1. Press ENTER. The Adjustment menu appears.

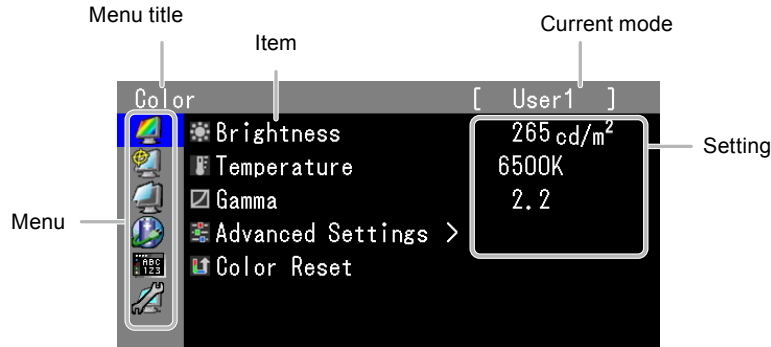

2. Adjusting/Setting

1. Choose a menu to adjust/set with ▲, ▼, and then press ENTER.



2. Choose an item to adjust/set with ▲, ▼, and then press ENTER.

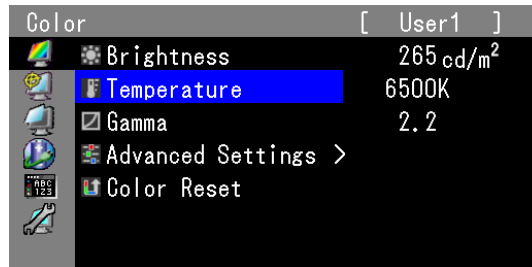

3. Adjust/set the selected item with ▲, ▼, and then press ENTER.

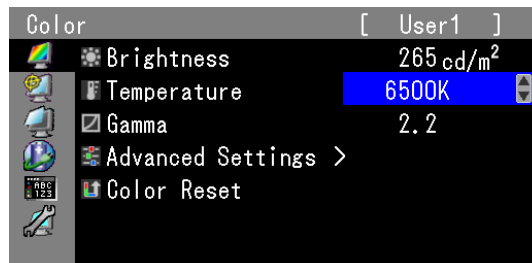

3. Exiting the software

1. Press RETURN a few times. The Adjustment menu finishes.

● Showing Button Guide

Press the front buttons (except  button), the button guide appears above the button. (When using the monitor with “Portrait” position, the button guide appears next to the button.)

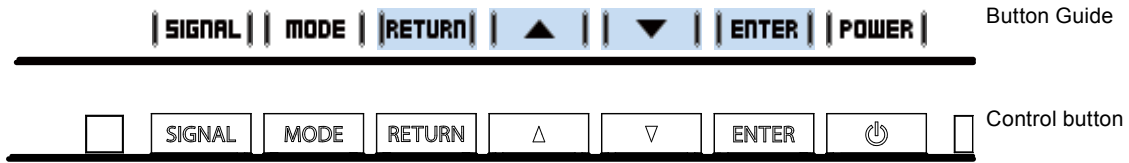













Note

- The button guide will continue to appear while the Adjustment menu or Mode menu is showing.
 - The button guide is displayed differently depending on the selected menu or status.
 - In CAL mode, although Button Guide are displayed above the ▲ and ▼ buttons, the brightness cannot be adjusted.
-

● Functions

The following table shows the menus for adjustment and setting items of each menu.

Main Menu	Item	Reference	
Color ^{*1} 	Brightness	"2-3. Adjusting Color" (page 18)	
	Temperature		
Gamma			
Advanced Settings	Hue		
	Saturation		
	Contrast Enhancer		
	Outline Enhancer		
	Clipping		
	Gain		
	6 Colors		
	Color Reset	"3-10. Reset to default" (page 36)	
SelfCorrection 	Execute	"4-1. Executing SelfCorrection" (page 38)	
Screen 	Screen Size	"2-6. Selecting Screen Size" (page 29)	
	Overdrive	"2-7. Configuring Moving Image Performance" (page 31)	
	Color Space	"2-8. Specifying Color Space" (page 32)	
	Range Extension	"2-5. Expanding Signal Output Range" (page 28)	
	HDMI Settings ^{*2}	Noise Reduction	"2-9. Setting HDMI" (page 32)
	Analog Adjustment ^{*3}	Auto Adjustment	"2-4. Adjusting Screens" (page 25)
		Range Adjustment	
		Clock	
		Phase	
		Hor. Position	
	Ver. Position		
Power Manager 	Power Save	"5-1. Setting Power Save" (page 39)	
	Auto EcoView	"5-2. Enabling/Disabling Automatic Brightness Adjustment" (page 40)	
	Indicator	"5-4. Adjusting the Brightness of Indicator" (page 40)	
	EcoView Index	"5-3. Checking the Power Saving Level" (page 40)	
Menu Settings 	Language	"3-2. Selecting the Language" (page 33)	
	Orientation	"3-3. Setting Orientation" (page 33)	
	Menu Position	"3-4. Changing Adjustment Menu Display Position" (page 34)	

Tools 	 Input Selection		“To switch among input signals” (page 48)
	 Mode Preset		“3-1. Enabling/Disabling Mode Selection” (page 33)
	 USB Selection	DVI	“3-8. Switching USB Port Automatically” (page 35)
		DisplayPort	
		HDMI	
	 Signal Info		“7-4. Showing Monitor Information” (page 50)
 Monitor Info			
 All Reset		“3-10. Reset to default” (page 36)	

*1 The adjustment/settings available on the “Color” menu depend on the selected mode. (See [“2-3. Adjusting Color” \(page 18\)](#))

*2 This setting can be adjusted with HDMI signal input.

*3 These functions can be adjusted with analog input.

Chapter 2 Adjusting Screens

2-1. Compatible Resolutions

The monitor supports the following resolutions.

● Analog Input (DVI-I)

Resolution	Applicable Signals	Vertical scan frequency	Dot clock (Max.)	CS230	CX240
640 × 480	VGA	60 Hz	149.0 MHz (CS230) 164.5 MHz (CX240)	√	√
720 × 400	VGA TEXT	70 Hz		√	√
800 × 600	VESA	60 Hz		√	√
1024 × 768	VESA	60 Hz		√	√
1280 × 960	VESA	60 Hz		√	√
1280 × 1024	VESA	60 Hz		√	√
1600 × 1200	VESA	60 Hz		-	√
1680 × 1050	VESA CVT, VESA CVT RB	60 Hz		√	√
1920 × 1080 ^{*1}	VESA CVT RB	60 Hz		√	√
1920 × 1080 ^{*1}	CEA-861	60 Hz		√	-
1920 × 1200 ^{*2}	VESA CVT RB	60 Hz		-	√

● Digital Input (DVI / DisplayPort)

Resolution	Applicable Signals	Vertical scan frequency	Dot clock (Max.)	CS230	CX240
640 × 480	VGA	60 Hz	149.0 MHz (CS230) 164.5 MHz (CX240)	√	√
720 × 400	VGA TEXT	70 Hz		√	√
800 × 600	VESA	60 Hz		√	√
1024 × 768	VESA	60 Hz		√	√
1280 × 960	VESA	60 Hz		√	√
1280 × 1024	VESA	60 Hz		√	√
1600 × 1200	VESA	60 Hz		-	√
1680 × 1050	VESA CVT, VESA CVT RB	60 Hz		√	√
1920 × 1080 ^{*1}	VESA CVT RB	60 Hz		√	√
1920 × 1200 ^{*2}	VESA CVT RB	60 Hz		-	√

● Digital Input (HDMI)

- Video signal
 - VGA / 480i,480p,1080i,720p,1080p: 60 Hz
 - 576i,576p,1080i,720p,1080p: 50 Hz
 - 1080p: 24 Hz, 25 Hz, 30 Hz

The graphics board should comply with the VESA standard and CEA-861 standard.

See “3-7. Setting Signal Bandwidth” (page 35).

*1 Recommended resolution (CS230)

*2 Recommended resolution (CX240)

2-2. Setting the Resolution

When you connect the monitor to the PC and find that the resolution is improper, or when you want to change the resolution, follow the procedure below.

● Windows 10

1. Right-click the mouse anywhere on the desktop except for icons.
2. From the displayed menu, click “Display Settings”.
3. On the “Customize your display” dialog box, click “Advanced display settings”.
4. Select a monitor, then choose a resolution from the “Resolution” pull-down menu.
5. Click the “Apply” button.
6. When a confirmation dialog box is displayed, click “Keep changes”.

● Windows 8.1 / Windows 7

1. For Windows 8.1, click the “Desktop” tile on the Start Screen to display the desktop.
2. Right-click the mouse anywhere on the desktop except for icons.
3. From the displayed menu, click “Screen resolution”.
4. On the “Screen Resolution” dialog box, select the monitor.
5. Click “Resolution” to select the desired resolution.
6. Click the “OK” button.
7. When a confirmation dialog box is displayed, click “Keep changes”.

● Windows Vista

1. Right-click the mouse anywhere on the desktop except for icons.
2. From the displayed menu, click “Personalize”.
3. On the “Personalization” window, click “Display Settings”.
4. On the “Display Settings” dialog box, select the “Monitor” tab and select desired resolution in the “Resolution” field.
5. Click the “OK” button.
6. When a confirmation dialog box is displayed, click “Yes”.

● Windows XP

1. Right-click the mouse anywhere on the desktop except for icons.
2. From the displayed menu, click “Properties”.
3. When the “Display Properties” dialog box is displayed, click the “Settings” tab and select desired resolution for “Screen resolution” under “Display”.
4. Click the “OK” button to close the dialog box.

● OS X Mountain Lion (10.8) and later

1. Select “System Preferences” from the Apple menu.
2. When the “System Preferences” dialog box is displayed, click “Displays”. (For Mac OS X Mountain Lion (10.8), click “Displays” for “Hardware”.)
3. On the displayed dialog box, select the “Display” tab, then choose “Change” for “Resolutions”.
4. The list of selectable resolutions is displayed. Select the desired resolution.
If the desired resolution is not displayed in the list, hold down the Option key and select “Change”.
5. Your selection will be reflected immediately.
6. When you are satisfied with the selected resolution, close the window.

● Mac OS X 10.7

1. Select “System Preferences” from the Apple menu.
2. When the “System Preferences” dialog box is displayed, click “Displays” for “Hardware”.
3. On the displayed dialog box, select the “Display” tab and select desired resolution in the “Resolutions” field.
4. Your selection will be reflected immediately. When you are satisfied with the selected resolution, close the window.

2-3. Adjusting Color

● To select the display mode (color mode)

This function allows easy selection of a desired mode according to monitor application.

Display Modes

Mode		Purpose
CS230	CX240	
1-User1	1-User1	Available for the color settings according to your preference.
2-User2	2-User2	
3-User3	3-User3	
4-Paper	4-Paper	Produces a printed paper effect. Suitable for displaying images from media such as books and documents.
-	5-Adobe®RGB	Suitable for color matching with Adobe®RGB compatible peripherals.
5-sRGB	6-sRGB	Suitable for color matching with sRGB compatible peripherals.
6-CAL	7-CAL	Displays the screen adjusted by “ColorNavigator” Color Management Software and “ColorNavigator Elements” Photo Color Matching Software.

Note

- In CAL mode, ColorNavigator and ColorNavigator Elements can be used for adjustment.
- Available CAL mode differs depending on each input signal.

Attention

- Avoid operating any function of the monitor while using ColorNavigator and/or ColorNavigator Elements. Regarding ColorNavigator and ColorNavigator Elements, see [“To use ColorNavigator / ColorNavigator Elements” \(page 10\)](#).

Example: At DVI input (CX240)

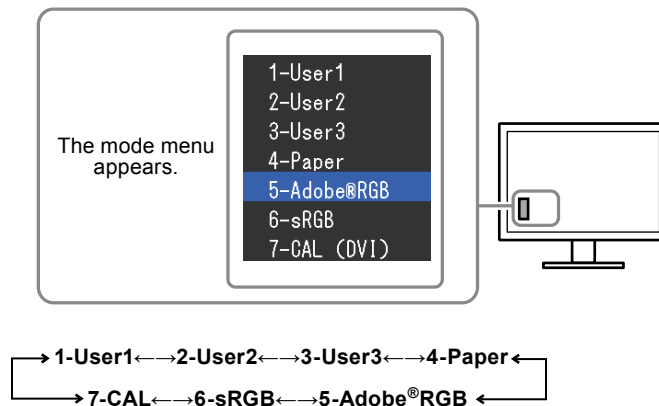

Procedure

1. Press MODE.
The mode menu appears at the bottom left of the screen.
2. The mode among the list is highlighted in turn each time MODE is pressed.
You can switch the mode with ▲ or ▼ while the mode menu is displayed.

Note

- The Adjustment menu and the Mode menu cannot be displayed at the same time.
- You can disable a specific mode to be selected. For more information, see [“3-1. Enabling/Disabling Mode Selection” \(page 33\)](#).
- “ScreenManager Pro for LCD” allows you to select the color mode automatically according to the application used (see “Chapter 3 Auto FineContrast” in the “ScreenManager Pro for LCD” User’s Manual).

● To perform advanced adjustments

“Color” of the Adjustment menu allows you to configure and save a separate set of color settings for each mode.

Attention

- As it takes about 30 minutes (CS230) / 7 minutes (CS240: under our measurement conditions) for the performance of electrical parts to stabilize. Please wait 30 minutes (CS230) / 7 minutes (CX240) or more after the monitor power has been turned on, and then adjust the monitor.
- Perform the range adjustment first when adjusting color for analog signals (see [“To adjust color gradation automatically” \(page 28\)](#)).
- The same image may be seen in different colors on multiple monitors due to their monitor-specific characteristics. Make fine color adjustment visually when matching colors on multiple monitors.

Note

- The values shown in “%” or “K” are available only as reference.
- Using the “ScreenManager Pro for LCD” allows you to perform the color adjustment by using the mouse and keyboard of your PC. The adjusted conditions can be stored as the color data to be read in later. (See “Chapter 4 Color Adjustment” in the User’s Manual for “ScreenManager Pro for LCD”.)
- Using ColorNavigator enables the monitor adjustment that prioritizes color matching of multiple monitors. For details, refer to the ColorNavigator User’s Manual.

● Adjustable settings in each mode

The adjustable settings depend on the mode. (You cannot select any non-adjustable or non-settable function.)
The adjustments or settings made for each mode are applied to all input signals.

√: Adjustable -: Not adjustable

Function	Color Mode							
	CS230	1-User1	2-User2	3-User3	4-Paper	-	5-sRGB	6-CAL
	CX240	1-User1	2-User2	3-User3	4-Paper	5-Adobe®RGB	6-sRGB	7-CAL
Brightness	√	√	√	√	√	√	√	-
Temperature	√	√	√	√	√	√	√	-
Gamma	√	√	√	-	-	√	√	-
Hue	√	√	√	-	-	-	-	-
Saturation	√	√	√	-	-	-	-	-
Contrast Enhancer	√	√	√	-	-	-	-	-
Outline Enhancer	√	√	√	√	√	√	√	-
Clipping	-	-	-	-	-	√	√	-
Gain	√	√	√	-	-	-	-	-
6 Colors	√	√	√	-	-	-	-	-

● Adjusting Brightness

The screen brightness is adjusted by changing the brightness of the backlight (light source from the LCD back panel).

Setting Range

50 cd/m² to 300 cd/m²

Procedure

1. Press ▲ or ▼.
The Brightness menu appears.
2. Use ▲ or ▼ for adjustment.
3. Press ENTER to exit.

Attention

- If the entered value cannot be set, the value will appear in magenta. In such a case, change the value.

Note

- Alternatively, you can use “Brightness” under “Color” in the Adjustment menu to adjust it.
 - The values shown in “cd/m²” are available only as reference.
-

● Adjusting the temperature

The color temperature can be adjusted.

The color temperature is normally used to express the hue of “White” and/or “Black” by a numerical value.

The value is expressed in degrees “K” (Kelvin).

The screen becomes reddish at a low color temperature, and bluish at a high color temperature, like the flame temperature. The gain preset values are set for each color temperature setting value.

Setting Range

Native, 4000K-10000K (specified every 100K), Standard

Procedure

1. Choose “Color” from the Adjustment menu, and press ENTER.
2. Choose “Temperature” from “Color”, and press ENTER.
3. Use ▲ or ▼ for adjustment.
4. Press ENTER to exit.

Note

- “Gain” allows you to perform more advanced adjustment (see [“Adjusting Gain” \(page 24\)](#)).
 - If you set “Native”, the image is displayed in the preset color of the monitor (Gain: 100% for each RGB).
 - When gain is changed, the color temperature is changed to “User”.
 - The default setting for each Adobe® RGB(CX240 only)/sRGB mode is set to “Standard”, which is the temperature in conformity with each standard.
-

● Adjusting Gamma

Gamma can be adjusted. The brightness of the monitor varies depending on the input signal, however, the variation rate is not proportional to the input signal. To keep the balance between the input signal and the brightness of the monitor is called as “Gamma correction”.

Setting Range

1.6-2.7, Standard

Procedure

1. Choose “Color” from the Adjustment menu, and press ENTER.
2. Choose “Gamma” from “Color”, and press ENTER.
3. Use ▲ or ▼ for adjustment.
4. Press ENTER to exit.

Note

- The default setting for each Adobe®RGB(CX240 only)/sRGB mode is set to “Standard”, which is the gamma in conformity with each standard.
 - The gamma curve can be adjusted to L* by using ColorNavigator. For details, refer to the ColorNavigator User’s Manual.
-

● Adjusting Hue

This function allows you to adjust the hue.

Setting Range

-100 to 100

Procedure

1. Choose “Color” from the Adjustment menu, and press ENTER.
2. Choose “Advanced Settings” from “Color”, and press ENTER.
3. Choose “Hue”, and press ENTER.
4. Use ▲ or ▼ for adjustment.
5. Press ENTER to exit.

Attention

- Using this function may make some color gradations unavailable for display.
-

● Adjusting Saturation

This function allows you to adjust color saturation.

Setting Range

-100 to 100

Procedure

1. Choose “Color” from the Adjustment menu, and press ENTER.
2. Choose “Advanced Settings” from “Color”, and press ENTER.
3. Choose “Saturation”, and press ENTER.
4. Use ▲ or ▼ for adjustment.
5. Press ENTER to exit.

Attention

- Using this function may make some color gradations unavailable for display.

Note

- The minimum value (-100) changes the screen to monochrome.
-

● To enable/disable Contrast Enhancer

This feature manages the brightness and gain levels of the backlight to match the image displayed while also improving the sense of contrast of images by correcting gamma values.

Procedure

1. Choose “Color” from the Adjustment menu, and press ENTER.
2. Choose “Advanced Settings” from “Color”, and press ENTER.
3. Choose “Contrast Enhancer”, and press ENTER.
4. Select “On” or “Off” with ▲ or ▼.
5. Press ENTER to exit.

● To enhance outline of image

OutlineEnhancer functions to emphasize outline of the images by emphasizing the color difference between pixels composing the images. This may improve the texture of the material and its feel of the images. On the contrary, it also functions to reproduce the images smoothly by gradating its outline.

Procedure

1. Choose “Color” from the Adjustment menu, and press ENTER.
2. Choose “Advanced Settings” from “Color”, and press ENTER.
3. Choose “Outline Enhancer”, and press ENTER.
4. Select the display status in the range from -3 to 3 (soft to sharp) with ▲ or ▼ as desired.
5. Press ENTER to exit.

● To set clipping

This function allows you to display the monitor with the colors based on the standard values of the defined color gamut (such as sRGB). The method of displaying the defined color gamut outside the normal gamut of the monitor can be set.

Procedure

1. Choose “Color” from the Adjustment menu, and press ENTER.
2. Choose “Advanced Settings” from “Color”, and press ENTER.
3. Choose “Clipping”, and press ENTER.
4. Select “On” or “Off” with ▲ or ▼.

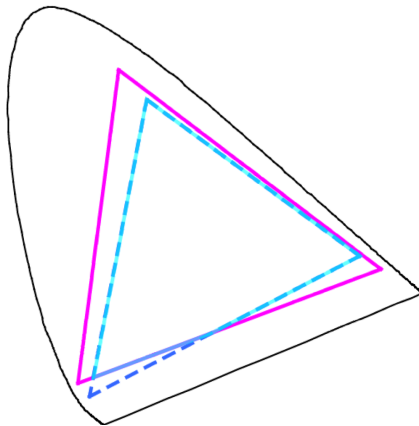

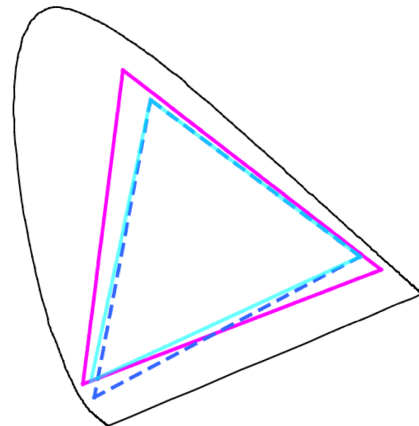

On:

Displays colors based on the standard values. The colors outside the gamut of the monitor are clipped.



Off:

Displays colors with priority on the color gradation rather than the color accuracy. The primary colors outside the gamut of the monitor (blue in the diagram) are adjusted to the colors most similar to those that can be displayed by the monitor.

	Color gamut of monitor
	Color gamut defined by standard
	Color gamut displayed on screen

Attention

- This is a conceptual diagram, and does not display the actual color gamut of the monitor.

5. Press ENTER to exit.

Attention

- This function can be set only in the color mode specified by the color gamut standard.

● Adjusting Gain

The brightness of each color component red, green, and blue is called Gain. You can change the hue of “white” by adjusting gain.

Setting Range

0% to 100%

Procedure

1. Choose “Color” from the Adjustment menu, and press ENTER.
2. Choose “Advanced Settings” from “Color”, and press ENTER.
3. Choose “Gain”, and press ENTER.
4. Choose the color for adjustment from “Red”, “Green”, and “Blue”, and press ENTER.
5. Use ▲ or ▼ for adjustment.
6. Press ENTER to exit.

Attention

- Using this function may make some color gradations unavailable for display.

Note

- The “Temperature” setting invalidates this setting.
 - The value of gain changes with that of color temperature.
 - When gain is changed, the color temperature is changed to “User”.
-

● Adjusting 6 Colors

The hue and saturation can be adjusted for each of six colors: Magenta, Red, Yellow, Green, Cyan, and Blue.

Adjustable Range

-100 to 100

Procedure

1. Choose “Color” from the Adjustment menu, and press ENTER.
2. Choose “Advanced Settings” from “Color”, and press ENTER.
3. Choose “6 Colors”, and press ENTER.
4. Choose the color for adjustment from “Magenta”, “Red”, “Yellow”, “Green”, “Cyan”, and “Blue”, and press ENTER.
5. Select “Hue” or “Saturation”, and press ENTER.
6. Use ▲ or ▼ for adjustment.
7. Press ENTER to exit.

2-4. Adjusting Screens

● Digital Signal Input

When digital signals are input, images are displayed correctly based on the preset data of the monitor, but if you perform more advanced adjustment, see “2-3. Adjusting Color” (page 18) and subsequent pages.

● Analog Signal Input

Attention

- As it takes about 30 minutes (CS230) / 7 minutes (CS240: under our measurement conditions) for the performance of electrical parts to stabilize. Please wait 30 minutes (CS230) / 7 minutes (CX240) or more after the monitor power has been turned on, and then adjust the monitor.
 - The Self Adjust (automatic screen adjustment) function does not work for the images under the resolution of 800 × 600 (SVGA).
 - The self adjustment and auto adjustment functions work correctly when an image is fully displayed over the Windows or Macintosh display area. They do not work properly in the cases below:
 - when an image is displayed only on a part of the screen (command prompt window, for example)
 - when a black background (wallpaper, etc.) is in useAlso, these functions cannot work properly in some graphic boards.
-

The monitor screen adjustment is used to suppress flickering of the screen or adjust screen position and screen size correctly according to the PC to be used.

Note

- The self adjustment function works when all of the following conditions are satisfied:
 - When a signal is input into the monitor for the first time or when a resolution or vertical/horizontal scan frequency not used before is set
-

If the screen is not displayed correctly even after performing the self adjustment operation, adjust the screen according to the procedures on the following pages to use the monitor comfortably.

How to Set

1. Perform the auto adjustment.

● To adjust flickering, screen position, and screen size automatically

Procedure

1. Choose “Screen” from the Adjustment menu, and press ENTER.
2. Choose “Analog Adjustment” from “Screen”, and press ENTER.
3. Choose “Auto Adjustment” from “Analog Adjustment”, and press ENTER.

Flickering, screen position, and screen size are corrected by the auto-adjustment function.

If the screen is not displayed correctly even after performing Auto Adjustment, perform the adjustments according to the procedures on the following pages. If the screen is displayed correctly, go to “[To enhance outline of image](#)” (page 22).

2. Prepare to use analog screen adjustment patterns.

Load the “EIZO LCD Utility Disk” to your PC, and then open the “Screen adjustment pattern files”.

Note

- For details and instructions on opening the “Screen adjustment pattern files”, refer to the Readme.txt file.

3. Perform the auto adjustment again with the analog screen adjustment pattern displayed.

● To adjust flickering, screen position, and screen size automatically

Procedure

1. Display Pattern 1 in full screen on the monitor using the “Screen adjustment pattern files”.

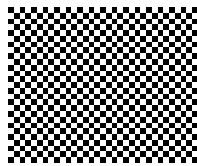

2. Choose “Screen” from the Adjustment menu, and press ENTER.
3. Choose “Analog Adjustment” from “Screen”, and press ENTER.
4. Choose “Auto Adjustment” from “Analog Adjustment”, and press ENTER.

Flickering, screen position, and screen size are corrected by the auto-adjustment function.

If the screen is not displayed correctly even after performing Auto Adjustment, perform the adjustments according to the procedures on the following pages. If the screen is displayed correctly, go to [“To enhance outline of image” \(page 22\)](#).

4. Choose “Screen” from the Adjustment menu to perform advanced adjustments.

Adjust the clock, phase and position, in this order.

● To eliminate vertical bars

Procedure

1. Choose “Analog Adjustment” from “Screen”, and press ENTER.
2. Choose “Clock” from “Analog Adjustment”, and press ENTER.
The “Clock” menu appears.
3. Adjust the clock with ▼ or ▲ to eliminate vertical bars.
Press ▼ or ▲ slowly so as not to miss the adjustment point.
4. Press ENTER to exit.

When blurring, flickering or bars appear on the screen after adjustment, proceed to “To remove flickering or blurring”.

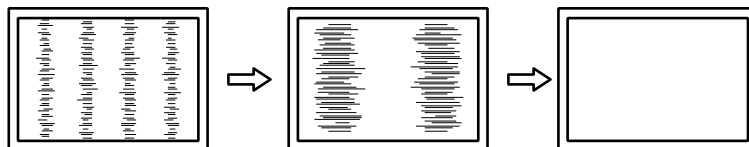

● To remove flickering or blurring

Procedure

1. Choose “Analog Adjustment” from “Screen”, and press ENTER.
2. Choose “Phase” from “Analog Adjustment”, and press ENTER.
The “Phase” menu appears.
3. Adjust the phase with ▼ or ▲ to minimize flickering or blurring.
4. Press ENTER to exit.

When vertical bars appear on the screen after adjustment, go back to “To eliminate vertical bars”.

(Clock → Phase → Position)

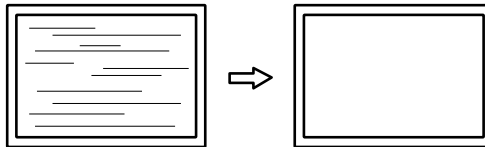

Attention

- Flickering or blurring may not be eliminated depending on your PC or graphics board.

● To correct the screen position

Note

- Since the number of pixels and the pixel positions are fixed on the LCD monitor, only one position is provided to display images correctly. The position adjustment is made to shift an image to the correct position.

Procedure

1. Choose “Analog Adjustment” from “Screen”, and press ENTER.
2. Choose “Hor. Position” or “Ver. Position” from “Analog Adjustment”, and press ENTER.
The “Hor.Position” or “Ver.Position” menu appears.
3. Adjust the position with ▼ or ▲.
4. Press ENTER to exit.

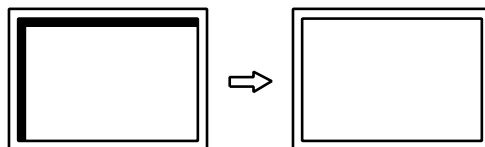

5. Close Pattern 1.

5. Adjusting color gradation.

● To adjust color gradation automatically

Every color gradation (0 to 255) can be displayed by adjusting the signal output level.

Procedure

1. Display Pattern 2 in full screen on the monitor using the “Screen adjustment pattern files”.

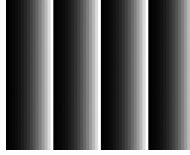

2. Choose “Screen” from the Adjustment menu, and press ENTER.
3. Choose “Analog Adjustment” from “Screen”, and press ENTER.
4. Choose “Range Adjustment” from “Analog Adjustment”, and press ENTER.
The output range is set automatically.
5. Close Pattern 2.

2-5. Expanding Signal Output Range

The output range of the signal is extended from 16 - 254 to 0 - 255 for display. When images are displayed in black and white within the restricted range for purposes such as image creation, use this setting to improve the contrast of the images.

Procedure

1. Choose “Screen” from the Adjustment menu, and press ENTER.
2. Choose “Range Extension” from “Screen”, and press ENTER.
3. Select “On”, “Off”, or “Auto” with ▲ or ▼.

Attention

- When the DVI signal is input, “Auto” cannot be selected.
-

4. Press ENTER to exit.

2-6. Selecting Screen Size

The image with the resolution other than the recommended resolution is displayed in full screen automatically. You can change the screen size by using the “Screen Size” function from “Screen”.

● DVI, DisplayPort signal input

Settings	Function
Full	Displays an image in full screen. Images are distorted in some cases because the vertical rate is not equal to the horizontal rate.
Enlarged	Displays an image in full screen. In some cases, a blank horizontal or vertical border appears to equalize the vertical rate and the horizontal rate.
Normal	Displays images with the specified resolution.

Example: Image size 1280×1024

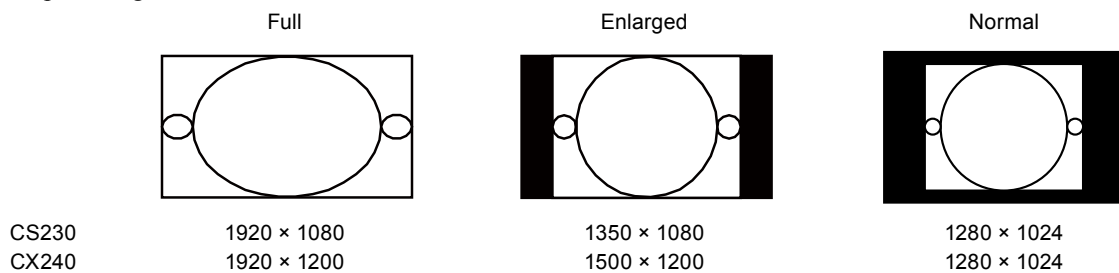

Procedure

1. Choose “Screen” from the Adjustment menu, and press ENTER.
2. Choose “Screen Size” from “Screen”, and press ENTER.
3. Select “Full”, “Enlarged”, or “Normal” with ▲ or ▼.
4. Press ENTER to exit.

Attention

- Selecting “Normal” may make some color gradations unavailable for display.

● HDMI (HD signal) input

Settings	Function
Enlarged	Displays an image in full screen. In some cases, a blank horizontal or vertical border appears to equalize the vertical rate and the horizontal rate.
Dot by Dot	Displays images with the specified resolution.

Example: 720p

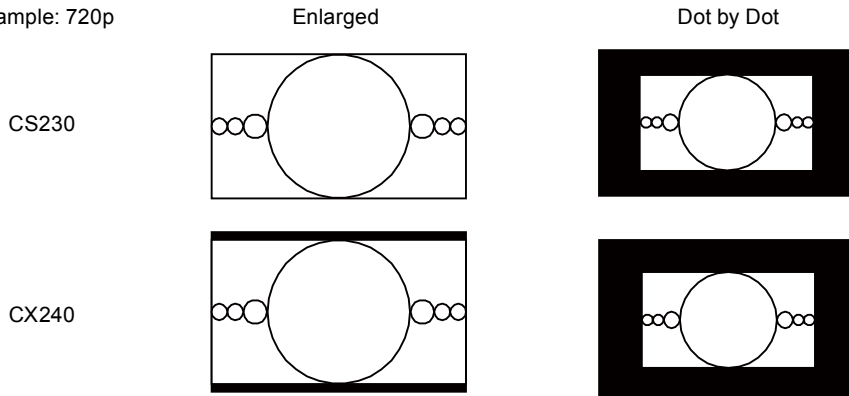

Procedure

1. Choose "Screen" from the Adjustment menu, and press ENTER.
2. Choose "Screen Size" from "Screen", and press ENTER.
3. Select "Enlarged", or "Dot by Dot" with ▲ or ▼.
4. Press ENTER to exit.

Attention

- For CX240, an image cannot be displayed using the entire screen when the HDMI signal is input.

● HDMI (SD signal) input

Settings	Function
Auto	The monitor automatically changes the screen size according to the aspect ratio sent from the auto input signal.
4:3	Displays images in a 4:3 format screen. Black bars appear on both sides of the screen. 16:9 images are horizontally compressed.
Letter Box	Displays 16:9 letterboxed images in full screen. Images other than the letterboxed ones are partly cut on top and bottom.
16:9	Displays the entire 16:9 image in full screen. Black bars appear on the top and bottom of the screen. 4:3 images are horizontally expanded.

Example: 480i/480p (16:9)

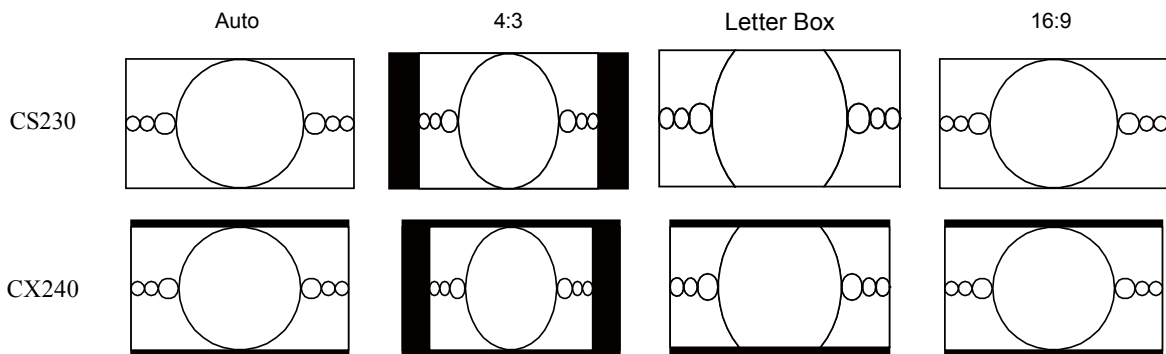

Procedure

1. Choose “Screen” from the Adjustment menu, and press ENTER.
2. Choose “Screen Size” from “Screen”, and press ENTER.
3. Select “Auto”, “4:3”, “Letter Box”, or “16:9” with ▲ or ▼.
4. Press ENTER to exit.

Attention

- For CX240, an image cannot be displayed using the entire screen when the HDMI signal is input.

2-7. Configuring Moving Image Performance

This function reduces visible afterimages that appear in fast moving images. If noise or afterimage is adversely noticeable, set the “Overdrive” setting to “Off”.

Default setting: On

Procedure

1. Choose “Screen” from the Adjustment menu, and press ENTER.
2. Choose “Overdrive” from “Screen”, and press ENTER.
3. Select “On” or “Off” with ▲ or ▼.
4. Press ENTER to exit.

2-8. Specifying Color Space

The color space of the input signal is specified. Set to other than “Auto” if this product cannot display correct color.

Settings	Function
Auto	Identifies the color space of the input signal automatically.
YUV 4:2:2	Converts the color space of the input signal to a YUV 4:2:2 format.
YUV 4:4:4	Converts the color space of the input signal to a YUV 4:4:4 format.
RGB	Converts the color space of the input signal to an RGB format.

Procedure

1. Choose “Screen” from the Adjustment menu, and press ENTER.
2. Choose “Color Space” from “Screen”, and press ENTER.
3. Select “Auto”, “YUV 4:2:2”, “YUV 4:4:4”, or “RGB” with ▲ or ▼.
4. Press ENTER to exit.

Attention

- The setting is required when a DVI device is connected to the monitor (at the HDMI connector port) using the DVI-HDMI conversion connector.
- Even if “Auto” is set, correct color might not be displayed.

Note

- The color space at the DVI input is converted to an RGB format.

2-9. Setting HDMI

● Reducing Noise

The small noises that occur in dark images are reduced. Use this function to reduce noise and roughness in images.

Procedure

1. Choose “Screen” from the Adjustment menu, and press ENTER.
2. Choose “HDMI Settings” from “Screen”, and press ENTER.
3. Choose “Noise Reduction”, and press ENTER.
4. Select “On” or “Off” with ▲ or ▼.
5. Press ENTER to exit.

Attention

- Using the Noise Reduction function may deteriorate fine images.

Chapter 3 Setting Monitor

3-1. Enabling/Disabling Mode Selection

Allows you to select the specified modes only.

Use this function when all the display modes are not available or when keeping the display mode unchanged.

Procedure

1. Choose “Tools” from the Adjustment menu, and press ENTER.
2. Choose “Mode Preset” from “Tools”, and press ENTER.
3. Use ▲ or ▼ to select the mode to change, and press ENTER.
4. Select “On” or “Off” with ▲ or ▼.
5. Press ENTER to exit.

Attention

- You cannot set all the modes disable. Set at least one mode to “On”.
-

3-2. Selecting the Language

This function allows you to select a language for the Adjustment menu and messages.

Selectable languages

English/German/French/Spanish/Italian/Swedish/Japanese/Simplified Chinese/Traditional Chinese

Procedure

1. Choose “Menu Settings” from the Adjustment menu, and press ENTER.
2. Choose “Language” from “Menu Settings”, and press ENTER.
3. Select a language with ▲ or ▼.
4. Press ENTER to exit.

3-3. Setting Orientation

This function allows you to change the orientation of the Adjustment menu.

Procedure

1. Choose “Menu Settings” from the Adjustment menu, and press ENTER.
2. Choose “Orientation” from “Menu Settings”, and press ENTER.
3. Select “Landscape” or “Portrait” with ▲ or ▼.
4. Press ENTER to exit.
5. When selecting “Portrait”, turn the monitor screen 90° in clockwise direction.

Attention

- Make sure that the cables are correctly connected.
 - Make sure to turn the monitor screen after pulling up the screen to the uppermost position of the stand and setting the screen tilted upward.
-

Note

- When using the monitor screen in a portrait position, a graphics board that supports portrait display is required. When placing the monitor in a portrait position, the settings of your graphics board need to be changed. Refer to the User’s Manual of the graphics board for details. Please refer to our web site (<http://www.eizoglobal.com>) as well.
-

3-4. Changing Adjustment Menu Display Position



You can change the display position of the Adjustment menu.

Procedure

1. Choose “Menu Settings” from the Adjustment menu, and press ENTER.
2. Choose “Menu Position” from “Menu Settings”, and press ENTER.
3. Choose the position with ▲ or ▼.
4. Press ENTER to exit.

3-5. Showing and Hiding the EIZO Logo



Procedure

1. Press  to turn off the monitor.
2. Holding MODE down, press  for at least two seconds to turn on the monitor.
The “Optional Settings” menu appears.
3. Choose “Logo” from “Optional Settings”, and press ENTER.
4. Select “On” or “Off” with ▲ or ▼, and press ENTER.
5. Select “Finish” with ▲ or ▼.
6. Press ENTER.

3-6. Locking Operation Button

This function allows you to lock the settings status to prevent changing them.

Procedure

1. Press  to turn off the monitor.
2. Holding MODE down, press  for at least two seconds to turn on the monitor.
The “Optional Settings” menu appears.
3. Choose “Key Lock” from “Optional Settings”, and press ENTER.
4. Choose “Off”, “Menu”, or “All” with ▲ or ▼, and press ENTER.

Settings	Buttons that can be locked
Off (Default setting)	None (All buttons are enabled)
Menu	ENTER button
All	All buttons excluding 

5. Select “Finish” with ▲ or ▼.
6. Press ENTER.

3-7. Setting Signal Bandwidth

The range of frequency and detection sensitivity of the change in signal can be switched.

Attention

- This function cannot be used with HDMI input.
-

Procedure

1. Press \odot to turn off the monitor.
2. Holding MODE down, press \odot for at least two seconds to turn on the monitor.
The “Optional Settings” menu appears.
3. Choose “Signal Bandwidth” from “Optional Settings”, and press ENTER.
4. Choose the input signal to set with \blacktriangle or \blacktriangledown , and press ENTER.
5. Select “Normal” or “Wide” with \blacktriangle or \blacktriangledown , and press ENTER.
6. Press RETURN twice.
7. Select “Finish” with \blacktriangle or \blacktriangledown .
8. Press ENTER.

3-8. Switching USB Port Automatically

This function allows the input signal to link the USB upstream port when one monitor is connected to two PCs. This can switch the USB port automatically according to the switch of the input signal. To calibrate one monitor using two PCs, the USB cables do not need to be connected again. USB devices such as the mouse and keyboard connected to one monitor can be used with two PCs.

Attention

- To switch the USB port to be used, two USB cables are required. Prepare cables.
 - If a storage device such as a USB memory is connected to the monitor, remove the device before changing the setting. Otherwise, data may be lost or damaged.
 - The key arrangement of the keyboard cannot be changed.
-

Note

- When the “Input Selection” function is set to “Auto”, the USB port automatically switches according to the switch of the input signal.
 - The USB downstream port can be operated using the currently monitored PC.
-

Procedure

1. Choose “Tools” from the Adjustment menu, and press ENTER.
2. Choose “USB Selection” from “Tools”, and press ENTER.
3. Choose the input signal to set with \blacktriangle or \blacktriangledown , and press ENTER.
4. Select “USB-1” or “USB-2” with \blacktriangle or \blacktriangledown .
5. Press ENTER to exit.

3-9. Changing DUE (Digital Uniformity Equalizer) Setting







The DUE setting can be changed.

Settings	Function
Brightness	Makes the brightness and color of the whole screen uniform without changing the maximum brightness and contrast ratio. The brightness of a high gradation area is not corrected. Select this setting to prioritize the levels of the brightness and contrast over the uniformity in the high gradation area.
Uniformity (Default setting)	Makes the brightness and color of the whole screen uniform. The brightness of a high gradation area is also corrected so it is uniform. Select this setting to prioritize the uniformity over the levels of the brightness and contrast in the high gradation area.

Attention

- To change the DUE setting, the adjusted monitor display must be readjusted. Perform the target adjustment again using ColorNavigator or ColorNavigator Elements. Regarding ColorNavigator and ColorNavigator Elements, see [“To use ColorNavigator / ColorNavigator Elements” \(page 10\)](#).

Procedure

1. Press  to turn off the monitor.
2. Holding MODE down, press  for at least two seconds to turn on the monitor.
The “Optional Settings” menu appears.
3. Choose “DUE Priority” from “Optional Settings”, and press ENTER.
4. Select “Uniformity” or “Brightness” with  or , and press ENTER.
5. Select “Finish” with  or .
6. Press ENTER.

3-10. Reset to default

The setting values are reset to the default settings.

Attention

- After resetting, you cannot undo the operation.



Note

- Regarding the default setting, see [“Main Default Settings \(CS230, CX240\)” \(page 53\)](#).

● To reset the color adjustments

This function only resets the color adjustment value for the currently selected mode to the default settings.

Procedure

1. Choose “Color” from the Adjustment menu, and press ENTER.
2. Choose “Color Reset” from “Color”, and press ENTER.
3. Select “Execute” with  or .
4. Press ENTER.

● To reset all adjustments to the default settings

This function resets all adjustments to the default settings (except the “Optional Settings” menu and “USB Selection”).

Procedure

1. Choose “Tools” from the Adjustment menu, and press ENTER.
2. Choose “All Reset” from “Tools”, and press ENTER.
3. Select “Execute” with ▲ or ▼.
4. Press ENTER.

Chapter 4 SelfCorrection

This product is equipped with a built-in correction sensor. The conditions that have been adjusted using ColorNavigator and the measurement device, or ColorNavigator Elements can be maintained.

As the adjustment targets or interval times for SelfCorrection are set in advance using ColorNavigator or ColorNavigator Elements, the built-in correction sensor automatically executes regular display correction.

Attention

- To execute SelfCorrection, it is necessary to set the correction details. Set the target value in advance using ColorNavigator or ColorNavigator Elements. Regarding ColorNavigator and ColorNavigator Elements, see [“To use ColorNavigator / ColorNavigator Elements” \(page 10\)](#).

Note

- SelfCorrection can also be executed when there are no computer signals being input.
-

4-1. Executing SelfCorrection

Procedure

1. Choose “SelfCorrection” from the Adjustment menu, and press ENTER.
2. Choose “Execute” from “SelfCorrection”, and press ENTER.

The built-in correction sensor is activated, and SelfCorrection is executed.

Attention

- After selecting “Execute”, aging may be executed before the built-in correction sensor is executed.
-

Chapter 5 Power Saving Functions

5-1. Setting Power Save

This function allows you to set the monitor into the power saving mode according to the PC status. When the monitor has shifted to the power saving mode, the images on the screen are not displayed.

Attention

- Turning off the main power switch or unplugging the power cord completely shuts off power supply to the monitor.
- Devices connected to the USB downstream port work when the monitor is in power saving mode or when the power button of the monitor is Off (except when “USB Power Save” is set to “On” in “5-5. Setting USB Power Save” (page 41)). Therefore, power consumption of the monitor varies with connected devices even in the power saving mode.
- Five seconds before the monitor enters the power saving mode, it displays a preliminary message.

Procedure

1. Choose “PowerManager” from the Adjustment menu, and press ENTER.
2. Choose “Power Save” from “PowerManager”, and press ENTER.
3. Select “On” or “Off” with ▲ or ▼.
4. Press ENTER to exit.

Power Saving System

Analog Signal Input

This monitor complies with the VESA DPM standard.

PC		Monitor	Power Indicator
On		Operating mode	Blue
Power saving mode	STAND-BY SUSPENDED Off	Power saving mode	Orange

Digital Signal Input

- DVI signal input

This monitor complies with the “DVI DMPM” standard.

- DisplayPort signal input

This monitor complies with the “DisplayPort Standard V1.1a”.

PC		Monitor	Power Indicator
On		Operating mode	Blue
Power saving mode		Power saving mode	Orange

HDMI Signal Input

The monitor enters the power saving mode after five seconds in connection with the PC setting.

PC		Monitor	Power Indicator
On		Operating mode	Blue
Power saving mode		Power saving mode	Orange

Exiting the power saving mode

If the monitor receives input, it automatically exits the power saving mode and returns to the normal display mode.

5-2. Enabling/Disabling Automatic Brightness Adjustment

The ambient light sensor on the front side of the monitor detects the environmental brightness to adjust the screen brightness automatically and comfortably by using the Auto EcoView function.

Attention

- Be careful not to block the ambient light sensor on the lower side of the monitor when using the Auto EcoView function.
- Auto EcoView cannot be used when ColorNavigator and/or ColorNavigator Elements is used.

Procedure

1. Choose “PowerManager” from the Adjustment menu, and press ENTER.
2. Choose “Auto EcoView” from “PowerManager”, and press ENTER.
3. Select “On” or “Off” with ▲ or ▼.
4. Press ENTER to exit.

Note

- For this reason, as “Brightness” in the Adjustment menu is changed, the auto adjustment range is also changed.

5-3. Checking the Power Saving Level

The EcoView menu allows you to check Power Reduction, CO₂ Reduction, and Eco Performance Level. The more indicators light up representing the Eco Performance Level, the higher the power saving level attained.

Procedure

1. Choose “PowerManager” from the Adjustment menu, and press ENTER.
2. Choose “EcoView Index” from “PowerManager”, and press ENTER.
The “EcoView Index” appears.

5-4. Adjusting the Brightness of Indicator

The brightness of the power indicator (blue) can be adjusted. (Default setting: 4)

Procedure

1. Choose “PowerManager” from the Adjustment menu, and press ENTER.
2. Choose “Indicator” from “PowerManager”, and press ENTER.
3. Select the indicator brightness “Off” or in the range from 1 to 7 with ▲ or ▼ as desired.
4. Press ENTER to exit.

5-5. Setting USB Power Save

This function allows you to disable the USB connection according to the power saving mode of the monitor.

Attention

- When both the USB upstream port and the USB downstream port are connected to USB devices, the USB connection is not disabled even when “USB Power Save” is set to “On”.
-

Procedure

1. Press **⏻** to turn off the monitor.
2. Holding **MODE** down, press **⏻** for at least two seconds to turn on the monitor.
The “Optional Settings” menu appears.
3. Choose “USB Power Save” from “Optional Settings”, and press **ENTER**.
4. Select “On” or “Off” with **▲** or **▼**, and press **ENTER**.
5. Select “Finish” with **▲** or **▼**.
6. Press **ENTER**.

5-6. Setting DisplayPort Power Save

If the PC is connected to the DisplayPort connector, and when the power is turned on or off or when the monitor recovers from power saving mode, window or icon positions may be shifted. If that occurs, set this function to “Off”.

Procedure

1. Press **⏻** to turn off the monitor.
2. Holding **MODE** down, press **⏻** for at least two seconds to turn on the monitor.
The “Optional Settings” menu appears.
3. Choose “DP Power Save” from “Optional Settings”, and press **ENTER**.
4. Select “On” or “Off” with **▲** or **▼**, and press **ENTER**.
5. Select “Finish” with **▲** or **▼**.
6. Press **ENTER**.

Chapter 6 Troubleshooting

If a problem still remains after applying the suggested remedies, contact your local EIZO representative.

6-1. No picture

Problem	Possible cause and remedy
<p>1. No picture</p> <ul style="list-style-type: none"> Power indicator does not light. <hr/> <ul style="list-style-type: none"> Power indicator is lighting blue. <hr/> <ul style="list-style-type: none"> Power indicator is lighting orange. <hr/> <ul style="list-style-type: none"> Power indicator flashes orange and blue. 	<ul style="list-style-type: none"> Check whether the power cord is connected properly. Turn the main power switch on. Press . Turn off the main power, and then turn it on again a few minutes later. <hr/> <ul style="list-style-type: none"> Increase "Brightness" and/or "Gain" in the Adjustment menu (see "To perform advanced adjustments" (page 19)). <hr/> <ul style="list-style-type: none"> Switch the input signal with SIGNAL. Operate the mouse or keyboard. Check whether the PC is turned on. <hr/> <ul style="list-style-type: none"> The DisplayPort or HDMI connection eventually cause a problem. Please switch the monitor off and on to solve the problem. Refer to the User's Manual of the output device for further details..
<p>2. The message below appears.</p> <ul style="list-style-type: none"> This message appears when no signal is input. Example: <div data-bbox="272 1093 671 1361" data-label="Image"> </div> <hr/> <ul style="list-style-type: none"> The message shows that the input signal is out of the specified frequency range. (Such signal frequency is displayed in magenta.) Example: <div data-bbox="272 1509 671 1845" data-label="Image"> </div> <p>fD: Dot Clock (displayed only during the digital signal input) fH: Horizontal Scan Frequency fV: Vertical scan frequency</p>	<p>This message appears when the signal is not input correctly even when the monitor functions properly.</p> <ul style="list-style-type: none"> The message shown left may appear, because some PCs do not output the signal soon after power-on. Check whether the PC is turned on. Check whether the signal cable is connected properly. Switch the input signal with SIGNAL. <hr/> <ul style="list-style-type: none"> Check whether the PC is configured to meet the resolution and vertical scan frequency requirements of the monitor (see "2-1. Compatible Resolutions" (page 15)). Reboot the PC. Select an appropriate setting using the graphics boards utility. Refer to the User's Manual of the graphics board for details.

6-2. Imaging problems

Problem	Possible cause and remedy
1. The screen is too bright or too dark.	<ul style="list-style-type: none"> Use "Brightness" in the Adjustment menu to adjust it. (The LCD monitor backlight has a limited life span.) When the screen becomes dark or begins to flicker, contact your local EIZO representative.
2. Characters are blurred.	<ul style="list-style-type: none"> Check whether the PC is configured to meet the resolution and vertical scan frequency requirements of the monitor (see "2-1. Compatible Resolutions" (page 15)). Use "Outline Enhancer" in the Adjustment menu to adjust it (see "To enhance outline of image" (page 22)).
3. Afterimages appear.	<ul style="list-style-type: none"> Afterimages are particular to LCD monitors. Avoid displaying the same image for a long time. Use the screen saver or power saving function to avoid displaying the same image for extended periods of time.
4. Green/red/blue/white dots or defective dots remain on the screen.	<ul style="list-style-type: none"> This is due to LCD panel characteristics and is not a failure.
5. Interference patterns or pressure marks remain on the screen.	<ul style="list-style-type: none"> Leave the monitor with a white or black screen. The symptom may disappear.
6. Noise appears on the screen.	<ul style="list-style-type: none"> In the Adjustment menu, set "Overdrive" to "Off" (see "2-7. Configuring Moving Image Performance" (page 31)). When entering the signals of HDCP, the normal images may not be displayed immediately.
7. (DisplayPort input) Display position of the windows changes.	<ul style="list-style-type: none"> When the signal is switched, the position of the window may be changed. In the Adjustment menu, set "DP Power Save" to "Off" (see "5-6. Setting DisplayPort Power Save" (page 41)).
8. Displays are abnormal.	<ul style="list-style-type: none"> Use "Screen" - "Color Space" (for the HDMI input) under the Adjustment menu to adjust it.
9. An image does not display on the entire screen.	<ul style="list-style-type: none"> The screen is set to a size other than "Full". Change the setting to "Full". For CX240, 1080i and 1080p are the maximum resolutions when the HDMI signal is input, so an image cannot be displayed using the entire screen.

6-3. Other problems

Problem	Possible cause and remedy
1. The adjustment menu does not appear.	<ul style="list-style-type: none"> • Check whether the operation lock function is active (see “3-6. Locking Operation Button” (page 34)).
2. No mode menu is displayed.	<ul style="list-style-type: none"> • Check whether the operation lock function is active (see “3-6. Locking Operation Button” (page 34)).
3. The monitor connected with the USB cable is not detected. / USB devices connected to the monitor does not work.	<ul style="list-style-type: none"> • Check whether the USB cable is connected correctly (see “7-3. Making Use of USB (Universal Serial Bus)” (page 49)). • Check the “Tools” – “USB Selection” settings under the Setting menu (see “3-8. Switching USB Port Automatically” (page 35)). • Change the USB port to another one. If the PC or peripheral devices works correctly by changing the USB port, contact your local EIZO representative. (Refer to the manual of the PC for details.) • Reboot the PC. • If the peripheral devices work correctly when the PC and peripheral devices are connected directly, please contact your local EIZO representative. • Check whether the PC and OS are USB compliant. (For USB compliance of the respective devices, consult their manufacturers.) • Check the PC’s BIOS setting for USB when using Windows. (Refer to the manual of the PC for details.)
4. Audio is not output.	<ul style="list-style-type: none"> • This monitor does not support the HDMI/DisplayPort audio signals.

6-4. Built-in correction sensor and SelfCorrection problems

Problem	Possible cause and remedy
1. The built-in correction sensor does not come out/stays out.	<ul style="list-style-type: none"> Turn off the main power, and then turn it on again a few minutes later.
2. SelfCorrection cannot be executed.	<ul style="list-style-type: none"> Check whether the ColorNavigator license is certified. (See “To use ColorNavigator / ColorNavigator Elements” (page 10).) Set the SelfCorrection target using ColorNavigator or ColorNavigator Elements.
3. SelfCorrection failure	<ul style="list-style-type: none"> Refer to the error code table. If an error code that does not appear in the error code table is displayed, contact your local EIZO representative.

Error Code Table

Error Code	Description
0014	<ul style="list-style-type: none"> Execute SelfCorrection again. Adjust using ColorNavigator or ColorNavigator Elements.
0034	<ul style="list-style-type: none"> The built-in correction sensor may not have come out during calibration, or light may have entered the sensor during measurement. Turn off the main power, wait for a few minutes before turning the power back on, and then execute SelfCorrection again.
0050	<ul style="list-style-type: none"> Execute SelfCorrection again.
0061	<ul style="list-style-type: none"> The built-in correction sensor may not have come out. Check whether there is any foreign object near the built-in correction sensor. Execute SelfCorrection again.

Chapter 7 Reference

7-1. Attaching the Optional Arm

An optional arm (or an optional stand) can be attached by removing the stand section. Please refer to our web site for the corresponding optional arm (or optional stand). <http://www.eizoglobal.com>

Attention

- When attaching an arm or stand, follow the instructions of their User's Manual.
- When using another manufacturer's arm or stand, confirm the following in advance and select one conforming to the VESA standard.
 - Clearance between the screw holes: 100 mm × 100 mm
 - Thickness of plate: 2.6 mm
 - Strong enough to support weight of the monitor unit (except the stand) and attachments such as cables.
- When using another manufacturer's arm or stand, use the following screws to secure it.
 - Screws fixing the stand to the monitor.
- When using an arm or stand, attach it to meet the following tilt angles of the monitor.
 - Up 45°, down 45°
- Connect the cables after attaching an arm or stand.
- Do not move the removed stand up and down. Doing so may result in injury or device damage.
- The monitor and arm or stand are heavy. Dropping them may result in injury or equipment damage.
- When setting the monitor to the portrait style, turn the monitor screen 90° in clockwise direction.

Procedure

1. Lay the LCD monitor on a soft cloth spread over on a stable surface with the panel surface facing down.

2. Remove the stand.

Prepare a screwdriver. Loosen the screws (four) securing the unit and the stand with the screwdriver.

3. Attach the arm or stand to the monitor.

Secure the monitor to the arm or stand using the screws fixing the stand to the monitor.

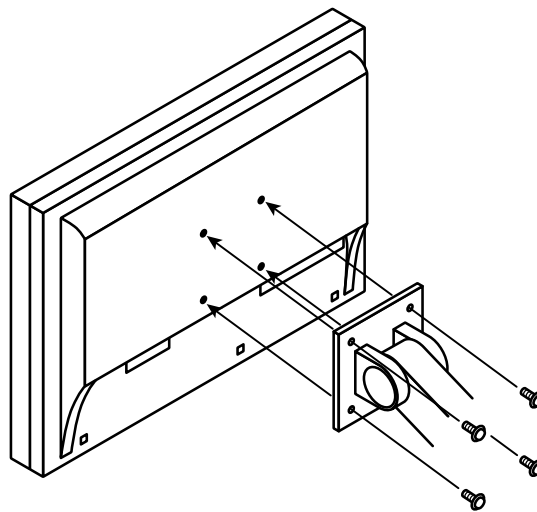

7-2. Connecting Multiple External Devices

The product has multiple connections to external devices and allows you to switch to one of the connections for display.

Connection examples

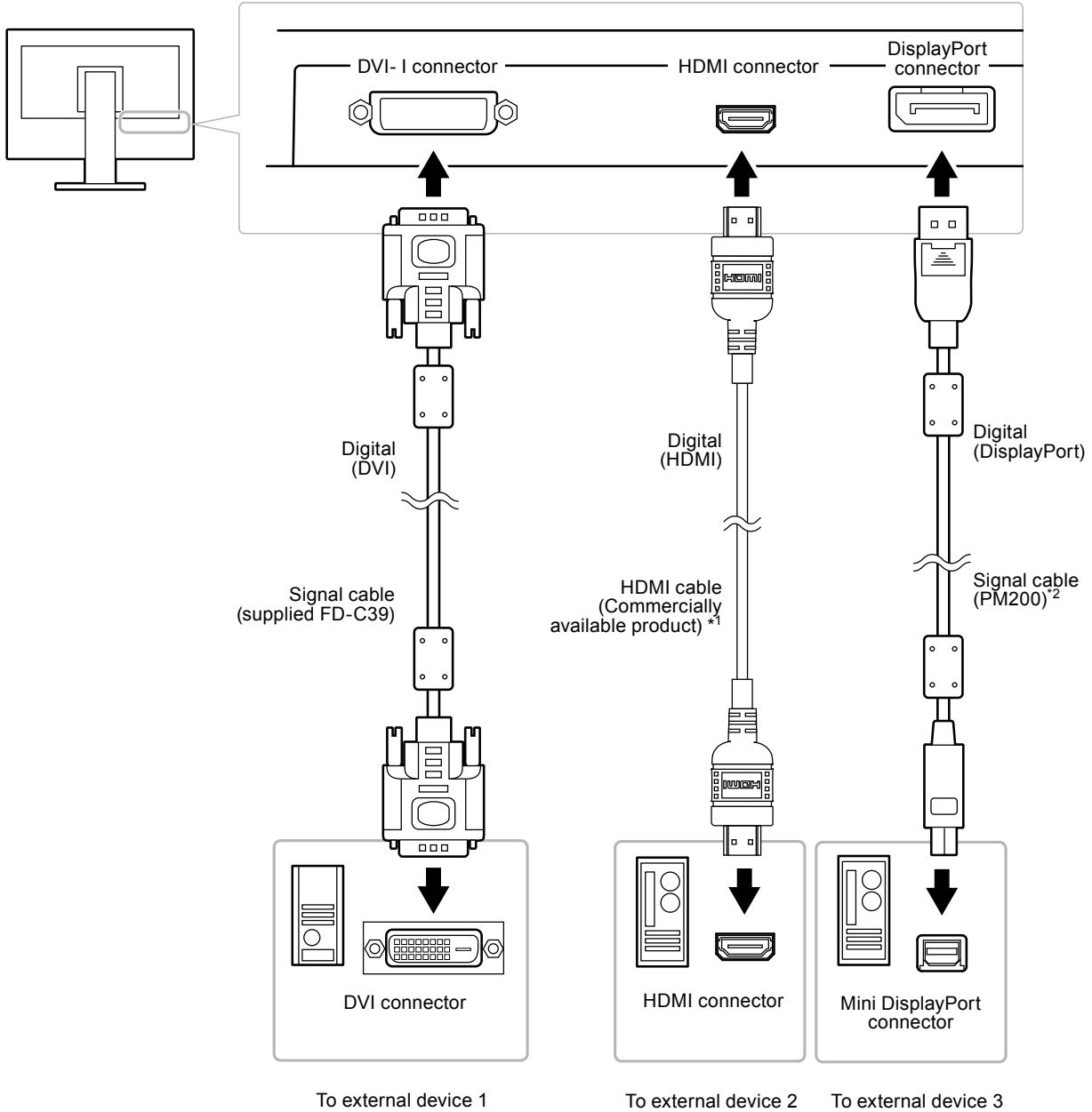

*1 Use a product able to handle High Speed .

*2 CS230:option, CX240:supplied

● To switch among input signals

The input signal switches each time SIGNAL is pressed.

When the signal is switched, the active input port name appears at the top right corner of the screen.

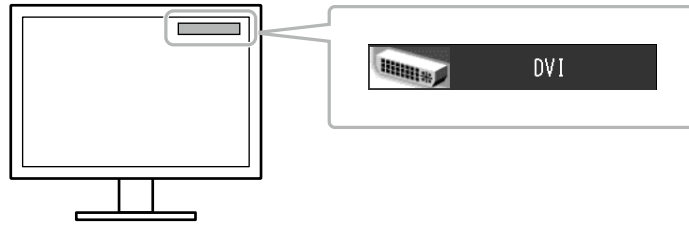

● To set input signal selection “Input Selection”

Settings	Function
Auto	The monitor recognizes the connector through which signals are input. When an external device enters the power saving mode, the monitor automatically displays another signal.
Manual	The monitor displays the signal from the selected connector despite the signal input. Select the input signal for display using the SIGNAL operation button.

Procedure

1. Choose “Tools” from the Adjustment menu, and press ENTER.
2. Choose “Input Selection” from “Tools”, and press ENTER.
3. Select “Auto” or “Manual” with ▲ or ▼.
4. Press ENTER to exit.

Note

- When “Auto” is selected for “Input Selection”, the monitor’s power saving function works only when all external devices are in the power saving mode.

7-3. Making Use of USB (Universal Serial Bus)

This monitor has a USB hub. Connected to a PC compatible with USB, this monitor functions as a USB hub allowing connection to peripheral USB devices.

● System Requirement

- A PC (including devices with a USB host function) and OS in conformance with USB Specification Revision 2.0
- USB cable

Attention

- This monitor may not work depending on PC, OS or peripheral devices. For USB compatibility of peripheral devices, contact their manufacturers.
- Devices connected to the USB upstream port and USB downstream port work when the monitor is in power saving mode or when the power button of the monitor is Off. Therefore, power consumption of the monitor varies with connected devices even in the power saving mode.
- When the main power of the monitor is Off, device connected to the USB downstream port does not operate.

● Procedure

1. Connect the signal cable between a PC and the monitor, and turn on the PC.
2. Using the USB cable, connect the computer's downstream port and the monitor's upstream port 1.
3. Connect the peripheral USB device to the USB downstream port of the monitor.

Note

- By default, USB upstream port 1 is enabled. To connect two PCs, see [“3-8. Switching USB Port Automatically”](#) (page 35).

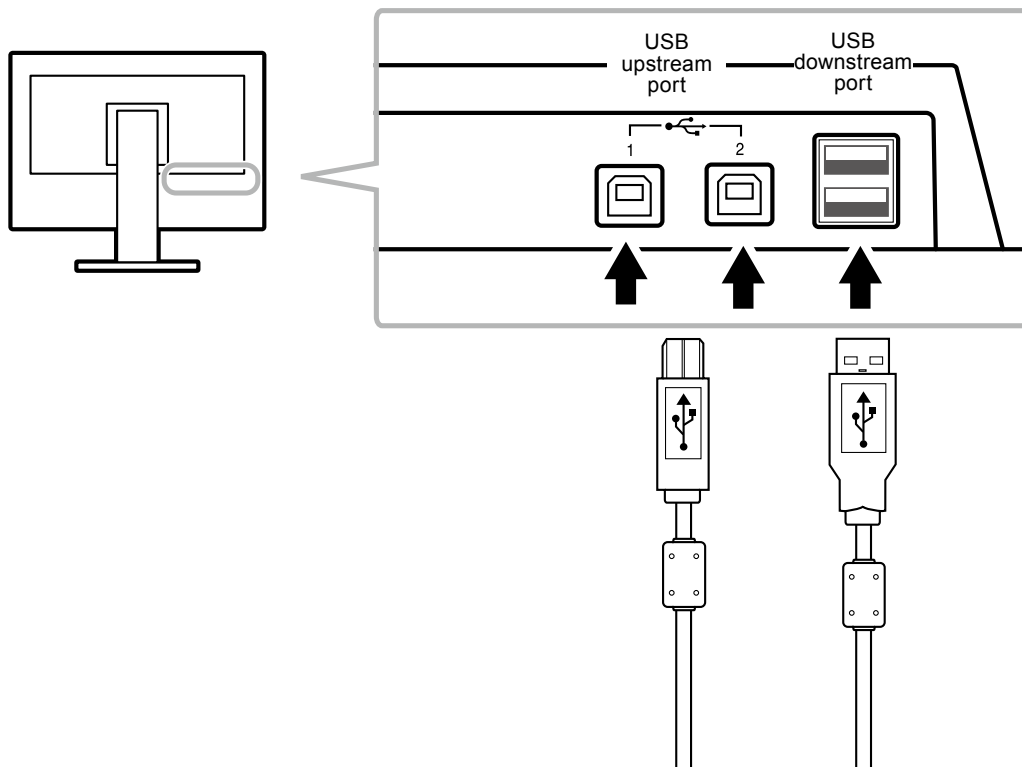

7-4. Showing Monitor Information

● Displaying signal information “Signal Info”

This function displays the information about the current input signals displayed.

Procedure

1. Choose “Tools” from the Adjustment menu, and press ENTER.
2. Choose “Signal Info” from “Tools”, and press ENTER.

The “Signal Info” appears.

(Example)

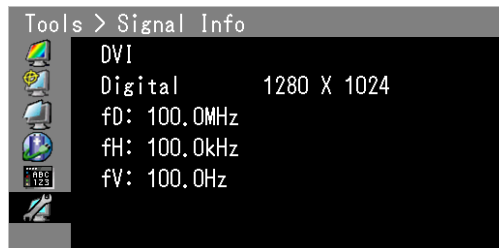

● Displaying Monitor Information “Monitor Info”

This function displays the information about the monitor.

Procedure

1. Choose “Tools” from the Adjustment menu, and press ENTER.
2. Choose “Monitor Info” from “Tools”, and press ENTER.

The “Monitor Info” appears.

This function displays the model name, serial number, firmware version, usage time, and ColorNavigator license status.

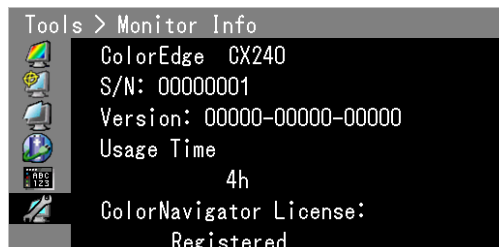

Attention

- The usage time is not always “0” when you purchase the monitor due to factory inspection.
 - If “ColorNavigator License” in the monitor information screen is “Not Registered”, the ColorNavigator license must be purchased and registered to the monitor. For the purchase of the license, contact your local EIZO representative.
-

7-5. Specifications

● CS230

LCD Panel	Size		23.0 inch (580 mm)
	Type		Color TFT, IPS, LED backlight
	Surface treatment		Hard Coating
	Surface hardness		3H
	Viewing angles		Horizontal 178°, vertical 178° (CR≥10)
	Dot pitch		0.265 mm
	Response time		Black-white-black: Approx. 15.2 ms Gray-to-gray: Approx. 10.5 ms
Horizontal scan frequency	Analog		26 kHz - 68 kHz
	Digital	DVI / DisplayPort	26 kHz - 68 kHz
		HDMI	15 kHz - 68 kHz
Vertical scan frequency	Analog		47.5 Hz - 61 Hz (non-interlace)
	Digital	DVI / DisplayPort	23.75 Hz - 63 Hz (non-interlace) (VGA TEXT: 69 - 71 Hz)
		HDMI	23.75 Hz - 61 Hz
Frame Synchronous mode			23.75 Hz - 30.5 Hz, 47.5 Hz - 61 Hz
Resolution			1920 dots × 1080 lines
Max. dot clock			149.0 MHz
Max. display color			Approx. 1073.74 million colors (for DisplayPort 10 bit)
Display area (H × V)			509.2 mm (20.0 inch) × 286.4 mm (11.3 inch)
Power supply			100 Vac - 120 Vac ±10%, 50/60 Hz 0.6A 200 Vac - 240 Vac ±10%, 50/60 Hz 0.4A
Power consumption	Screen display On		54 W or less
	Power saving mode		0.5 W or less (when only the DVI signal connector is connected, analog signal input, and no USB device is connected)
	Power Off		0.5 W or less (when no USB device is connected)
	Main power Off		0 W
Input signal connectors			DVI-I connector (Applicable to HDCP) DisplayPort connector (Standard V1.1a, applicable to HDCP) HDMI connector (Applicable to TypeA, HDCP)
Analog input signal (Sync)			Separate, TTL, positive / negative
Analog signal transmission system			Analog, positive (0.7 Vp-p / 75 Ω)
Digital signal (DVI/HDMI) transmission system			TMDS (Single Link)
Plug & Play			Digital (DVI-I): VESA DDC 2B / EDID structure 1.3 Digital (DisplayPort) : VESA DisplayPort / EDID structure 1.4
Dimensions (width) × (height) × (depth)	Main unit		544 mm (21.4 inch) × 372.5mm – 526.5 mm (14.7 inch - 20.7 inch) × 245.5 mm (9.7 inch)
	Main unit (without stand)		544 mm (21.4 inch) × 353 mm (13.9 inch) × 75 mm (3 inch)
Mass	Main unit		Approx. 7.9 kg (17.4 lbs.)
	Main unit (without stand)		Approx. 5.3 kg (11.7 lbs.)
Movable range			Tilt: Up 30°, down 0° Swivel: 344° Adjustable height: 195 mm (154 mm for tilt of 0°) Rotation: 90° (clockwise)

Environmental conditions	Temperature	Operating:	0°C to 35°C (32°F to 95°F)
		Storage/Transportation:	-20°C to 60°C (-4°F to 140°F)
	Humidity	Operating:	20% to 80% R.H. (no condensation)
		Storage/Transportation:	10% to 90% R.H. (no condensation)
	Air pressure	Operating:	700 hPa to 1060 hPa
		Storage/Transportation:	200 hPa to 1060 hPa
USB	Standard	USB Specification Revision 2.0	
	Port	Upstream port × 2, Downstream port × 2	
	Communication Speed	480 Mbps (high), 12 Mbps (full), 1.5 Mbps (low)	
	Supply current	Downstream:	Max. 500mA/1 port

● CX240

LCD Panel	Size		24.1 inch (610 mm)
	Type		Color TFT, IPS, LED backlight
	Surface treatment		Hard Coating
	Surface hardness		3H
	Viewing angles		Horizontal 178°, vertical 178° (CR≥10)
	Dot pitch		0.270 mm
	Response time		Black-white-black: Approx. 12 ms Gray-to-gray: Approx. 7.7 ms
Horizontal scan frequency	Analog		26 kHz - 78 kHz
	Digital	DVI / DisplayPort	26 kHz - 78 kHz
		HDMI	15 kHz - 68 kHz
Vertical scan frequency	Analog		47.5 Hz - 61 Hz (non-interlace)
	Digital	DVI / DisplayPort	23.75 Hz - 63 Hz (non-interlace) (VGA TEXT: 69 Hz - 71 Hz)
		HDMI	23.75 Hz - 61 Hz
Frame Synchronous mode			23.75 Hz - 30.5 Hz, 47.5 Hz - 61 Hz
Resolution			1920 dots × 1200 lines
Max. dot clock			164.5 MHz
Max. display color			Approx. 1073.74 million colors (for DisplayPort 10 bit)
Display area (H × V)			518.4 mm (20.4 inch) × 324.0 mm (12.8 inch)
Power supply			100Vac - 120 Vac ±10%, 50/60 Hz 1.0A 200Vac - 240 Vac ±10%, 50/60 Hz 0.6A
Power consumption	Screen display On		98 W or less
	Power saving mode		0.5 W or less (when only the DVI signal connector is connected, analog signal input, and no USB device is connected)
	Power Off		0.5 W or less (when no USB device is connected)
	Main power Off		0 W
Input signal connectors			DVI-I connector (Applicable to HDCP) DisplayPort connector (Standard V1.1a, applicable to HDCP) HDMI connector (Applicable to TypeA, HDCP)
Analog input signal (Sync)			Separate, TTL, positive / negative
Analog signal transmission system			Analog, positive (0.7 Vp-p / 75 Ω)
Digital signal (DVI/HDMI) transmission system			TMDS (Single Link)
Plug & Play			Digital (DVI-I): VESA DDC 2B / EDID structure 1.3 Digital (DisplayPort) : VESA DisplayPort / EDID structure 1.4
Dimensions (width) × (height) × (depth)	Main unit		575 mm (22.6 inch) × 417 mm – 545 mm (16.4 inch - 21.5 inch) × 245.5 mm (9.7 inch)
	Main unit (without stand)		575 mm (22.6 inch) × 398 mm (15.7 inch) × 75 mm (3 inch)

Mass	Main unit	Approx. 9.7 kg (21.4 lbs.)	
	Main unit (without stand)	Approx. 7.0 kg (15.4 lbs.)	
Movable range	Tilt:	Up 30°, down 0°	
	Swivel:	344°	
	Adjustable height:	195 mm (128 mm for tilt of 0°)	
	Rotation:	90° (clockwise)	
Environmental conditions	Temperature	Operating:	0°C to 35°C (32°F to 95°F)
		Storage/Transportation:	-20°C to 60°C (-4°F to 140°F)
	Humidity	Operating:	20% to 80% R.H. (no condensation)
		Storage/Transportation:	10% to 90% R.H. (no condensation)
	Air pressure	Operating:	700 hPa to 1060 hPa
		Storage/Transportation:	200 hPa to 1060 hPa
USB	Standard	USB Specification Revision 2.0	
	Port	Upstream port × 2, Downstream port × 2	
	Communication Speed	480 Mbps (high), 12 Mbps (full), 1.5 Mbps (low)	
	Supply current	Downstream: Max. 500mA/1 port	

Main Default Settings (CS230, CX240)

Color Mode	User1
Outline Enhancer	0
Screen Size	Full (DVI, DisplayPort) Enlarged (HDMI, HD) Auto (HDMI, SD)
Overdrive	On
Power Save	On
Auto EcoView	On
Language	English
Menu Position	Center
Input Selection	Manual
USB Power Save	Off
DP Power Save	On
DUE Priority	Uniformity

Outside Dimensions

CS230

Unit: mm (inch)

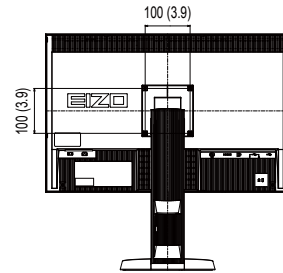
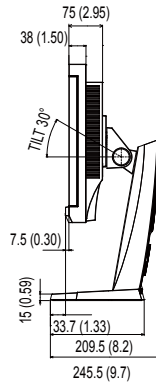
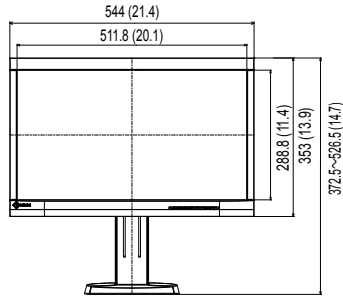
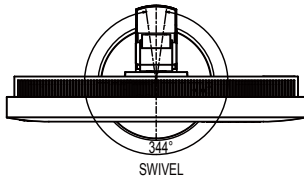

CX240

Unit: mm (inch)

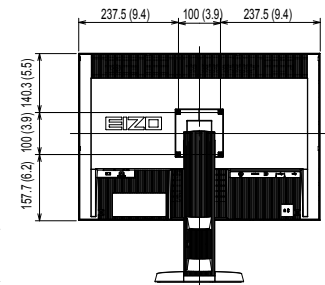
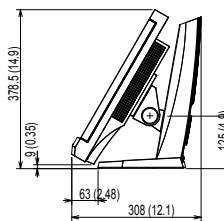
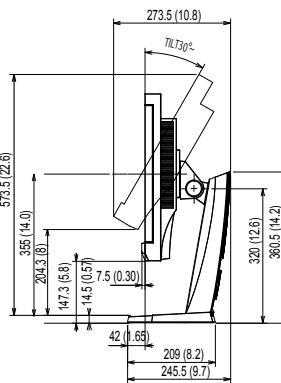
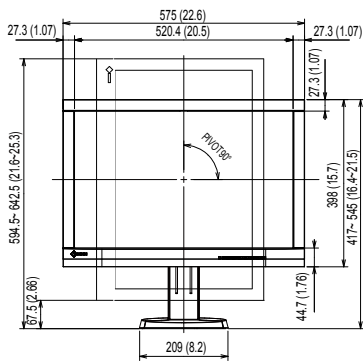
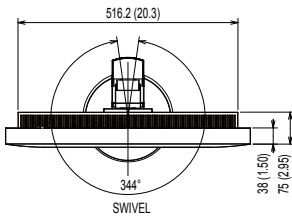

7-6. Preset Timing

The following table shows factory preset analog signal timing.

Attention

- Display position may be deviated depending on the PC connected, which may require screen adjustment using Adjustment menu.
- If a signal other than those listed in the table is input, adjust the screen using the Adjustment menu. However, screen display may still be incorrect even after the adjustment.
- When interlace signals are used, the screen cannot be displayed correctly even after screen adjustment using the Adjustment menu.

CS230

Resolution	Applicable Signals	Frequency			Polarity	
		Dot Clock: MHz	Horizontal: kHz	Vertical: Hz	Horizontal	Vertical
640 × 480	VGA	25.18	31.47	59.94	Negative	Negative
720 × 400	VGA TEXT	28.32	31.47	70.09	Negative	Positive
800 × 600	VESA	40.00	37.88	60.32	Positive	Positive
1024 × 768	VESA	65.00	48.36	60.00	Negative	Negative
1280 × 960	VESA	108.00	60.00	60.00	Positive	Positive
1280 × 1024	VESA	108.00	63.98	60.02	Positive	Positive
1680 × 1050	VESA CVT	146.25	65.29	59.95	Negative	Positive
1680 × 1050	VESA CVT RB	119.00	64.67	59.88	Positive	Negative
1920 × 1080	VESA CVT RB	138.50	66.59	59.93	Negative	Positive
1920 × 1080	CEA-861	148.50	67.50	60.00	Positive	Positive

CX240

Resolution	Applicable Signals	Frequency			Polarity	
		Dot Clock: MHz	Horizontal: kHz	Vertical: Hz	Horizontal	Vertical
640 × 480	VGA	25.18	31.47	59.94	Negative	Negative
720 × 400	VGA TEXT	28.32	31.47	70.09	Negative	Positive
800 × 600	VESA	40.00	37.88	60.32	Positive	Positive
1024 × 768	VESA	65.00	48.36	60.00	Negative	Negative
1280 × 960	VESA	108.00	60.00	60.00	Positive	Positive
1280 × 1024	VESA	108.00	63.98	60.02	Positive	Positive
1600 × 1200	VESA	162.00	75.00	60.00	Positive	Positive
1680 × 1050	VESA CVT	146.25	65.29	59.95	Negative	Positive
1680 × 1050	VESA CVT RB	119.00	64.67	59.88	Positive	Negative
1920 × 1080	VESA CVT RB	138.50	66.59	59.93	Negative	Positive
1920 × 1200	VESA CVT RB	154.00	74.04	59.95	Positive	Negative

7-7. Glossary

Adobe®RGB

This is a definition of the practical RGB color space proposed by Adobe Systems in 1998. The color reproduction range (color gamut) is broader than sRGB, and is highly adaptable to such fields as printing etc.

Clock

The analog signal input monitor needs to reproduce a clock of the same frequency as the dot clock of the graphics system in use, when the analog signal is converted to a digital signal for image display. This is called clock adjustment. If the clock pulse is not set correctly, some vertical bars appear on the screen.

Color Space

YUV and RGB, etc. are available. YUV expresses the color by using the luminance (Y), the color difference of Blue (U), and the color difference of Red (V). RGB does this by using the gradation of the 3 colors, Red (R), Green (G), and Blue (B).

DisplayPort

This is a next-generation digital AV interface used to connect PCs and audio-visual devices to the monitor. Both the video and sound signals can be transferred using one cable.

DVI (Digital Visual Interface)

DVI is a digital interface standard. DVI allows direct transmission of the PC's digital data without loss. This adopts the TMDS transmission system and DVI connectors. There are two types of DVI connectors. One is a DVI-D connector for digital signal input only. The other is a DVI-I connector for both digital and analog signal inputs.

DVI DMPM (DVI Digital Monitor Power Management)

DVI DMPM is a digital interface power saving function. The "Monitor ON (operating mode)" and "Active Off (power saving mode)" are indispensable for DVI DMPM as the monitor's power mode.

Gain

This is used to adjust each color parameter for red, green and blue. An LCD monitor displays the color by the light passing through the panel color filter. Red, green and blue are the three primary colors. All the colors on the screen are displayed by combining these three colors. The color tone can be changed by adjusting the light intensity (volume) passing through each color's filter.

Gamma

Generally, the relationship that the light intensity values of a monitor change nonlinearly to the input signal level is called "Gamma Characteristic". On the monitor, low gamma values display the whitish images and high gamma values display the high contrast images.

HDCP (High-bandwidth Digital Content Protection)

Digital signal coding system developed to copy-protect the digital contents, such as video, music, etc. This helps to transmit the digital contents safely by coding the digital contents sent via the DVI or HDMI connector on the output side and decoding them on the input side. Any digital contents cannot be reproduced if both of the equipments on the output and input sides are not applicable to HDCP system.

HDMI (High-Definition Multimedia Interface)

HDMI is a digital interface standard, developed for consumer electrical appliance or AV device. This standard is issued on the basis of the DVI standard which is one of an interface specification for the connection between a PC and a monitor. The projected image, sound and control signal without compressed enable to be transmitted with one cable.

Overdrive

This technology enhances response speed by increasing the potential difference at the time of motion of liquid-crystal pixels, and it is used for liquid-crystal TV sets and others in general. It provides clear-cut three-dimensional display with little afterimage, by improving response speed of the intermediate graduation range that frequently appears in moving images.

Resolution

The LCD panel consists of numerous pixels of specified size, which are illuminated to form images. This monitor consists of horizontal 1920 pixels and 1080(CS230) / 1200(CX240) vertical pixels. At a resolution of 1920×1080 (CS230) / 1920×1200 (CX240), all pixels are illuminated as a full screen (1:1).

sRGB (Standard RGB)

International standard for color reproduction and color space among peripheral devices (such as monitors, printers, digital cameras, scanners). As a form of simple color matching for the Internet, colors can be displayed using tones close to those of the transmission and reception devices.

Temperature

Color temperature is a method to measure the white color tone, generally indicated in degrees Kelvin. The screen becomes reddish at a low temperature, and bluish at a high temperature, like the flame temperature.

5000 K: Slightly reddish white

6500 K: White referred to as daylight-balanced color

9300 K: Slightly bluish white

TMDS (Transition Minimized Differential Signaling)

A signal transmission system for digital interface.

Appendix

Trademark

The DisplayPort Compliance Logo and VESA are registered trademark of the Video Electronics Standards Association.

Windows, Windows Vista, Windows Media, SQL Server, and Xbox 360 are registered trademarks of Microsoft Corporation in the United States and other countries.

Apple, Mac, Macintosh, iMac, eMac, Mac OS, MacBook, PowerBook, ColorSync, QuickTime, and iBook are registered trademarks of Apple Inc.

Acrobat, Adobe, Adobe AIR, and Photoshop are registered trademarks of Adobe Systems Incorporated in the United States and other countries.

PowerPC is a registered trademark of International Business Machines Corporation.

Pentium is a registered trademark of Intel Corporation in the United States and other countries.

AMD Athlon and AMD Opteron are trademarks of Advanced Micro Devices, Inc.

GRACoL and IDEAlliance are registered trademarks of International Digital Enterprise Alliance.

ColorVision, ColorVision Spyder2 are registered trademarks of DataColor Holding AG.

Spyder3 is a trademark of DataColor Holding AG.

Eye-One, ColorMunki, and X-Rite are registered trademarks or trademarks of X-Rite Incorporated.

TouchWare is a trademark of 3M Touch Systems, Inc.

NextWindow is a registered trademark of NextWindow Ltd.

RealPlayer is a registered trademark of RealNetworks, Inc.

NEC is a registered trademark of NEC Corporation. PC-9801 and PC-9821 are trademarks of NEC Corporation.

PlayStation is a registered trademark of Sony Computer Entertainment Inc.

PSP and PS3 are trademarks of Sony Computer Entertainment Inc.

ENERGY STAR is a registered trademark of the United States Environmental Protection Agency in the United States and other countries.

The terms HDMI and HDMI High-Definition Multimedia Interface, and the HDMI Logo are trademarks or registered trademarks of HDMI Licensing, LLC in the United States and other countries.

EIZO, the EIZO Logo, ColorEdge, DuraVision, FlexScan, FORIS, RadiForce, RadiCS, RadiNET, Raptor, and ScreenManager are registered trademarks of EIZO Corporation in Japan and other countries.

ColorNavigator, EIZO EasyPIX, EcoView NET, EIZO ScreenSlicer, i•Sound, Screen Administrator, and UniColor Pro are trademarks of EIZO Corporation.

All other company and product names are trademarks or registered trademarks of their respective owners.

License

A round gothic bold bit map font designed by Ricoh is used for the characters displayed on this product.

FCC Declaration of Conformity

For U.S.A. , Canada, etc. (rated 100-120 Vac) Only

FCC Declaration of Conformity

We, the Responsible Party

EIZO Inc.

5710 Warland Drive, Cypress, CA 90630

Phone: (562) 431-5011

declare that the product

Trade name: EIZO

Model: ColorEdge CS230/CX240

is in conformity with Part 15 of the FCC Rules. Operation of this product is subject to the following two conditions: (1) this device may not cause harmful interference, and (2) this device must accept any interference received, including interference that may cause undesired operation.

This equipment has been tested and found to comply with the limits for a Class B digital device, pursuant to Part 15 of the FCC Rules. These limits are designed to provide reasonable protection against harmful interference in a residential installation. This equipment generates, uses, and can radiate radio frequency energy and, if not installed and used in accordance with the instructions, may cause harmful interference to radio communications. However, there is no guarantee that interference will not occur in a particular installation. If this equipment does cause harmful interference to radio or television reception, which can be determined by turning the equipment off and on, the user is encouraged to try to correct the interference by one or more of the following measures.

- * Reorient or relocate the receiving antenna.
- * Increase the separation between the equipment and receiver.
- * Connect the equipment into an outlet on a circuit different from that to which the receiver is connected.
- * Consult the dealer or an experienced radio/TV technician for help.

Changes or modifications not expressly approved by the party responsible for compliance could void the user's authority to operate the equipment.

Note

Use the attached specified cable below or EIZO signal cable with this monitor so as to keep interference within the limits of a Class B digital device.

- AC Cord
- Shielded Signal Cable (Enclosed)

Canadian Notice

This Class B digital apparatus complies with Canadian ICES-003.

Cet appareil numérique de la classe B est conforme à la norme NMB-003 du Canada.

LIMITED WARRANTY

LIMITED WARRANTY

EIZO Corporation (hereinafter referred to as “**EIZO**”) and distributors authorized by EIZO (hereinafter referred to as the “**Distributors**”) warrant, subject to and in accordance with the terms of this limited warranty (hereinafter referred to as the “**Warranty**”), to the original purchaser (hereinafter referred to as the “**Original Purchaser**”) who purchased the product specified in this document (hereinafter referred to as the “**Product**”) from EIZO or Distributors, that EIZO and Distributors shall, at their sole discretion, either repair or replace the Product at no charge if the Original Purchaser becomes aware within the Warranty Period (defined below) that the Product malfunctions or is damaged in the course of normal use of the Product in accordance with the description in the instruction manual attached to the Product (hereinafter referred to as the “**User’s Manual**”).

The period of this Warranty is limited to (i) five (5) years from the date of purchase of the Product; or, limited to the expiration of (ii) 30,000 hours of its use of the Product (hereinafter referred to as the “**Warranty Period**”). EIZO and Distributors shall bear no liability or obligation with regard to the Product in relation to the Original Purchaser or any third parties other than as provided under this Warranty.

EIZO and Distributors will cease to hold or store any parts (excluding design parts) of the Product upon expiration of seven (7) years after the production of such parts is discontinued. In repairing the monitor, EIZO and Distributors will use renewal parts which comply with our QC standards. If the unit cannot be repaired due to its condition or the stockout of a relevant part, EIZO and Distributors may offer the replacement by a product with equivalent performance instead of repairing it.

The Warranty is valid only in the countries or territories where the Distributors are located. The Warranty does not restrict any legal rights of the Original Purchaser.

Notwithstanding any other provision of this Warranty, EIZO and Distributors shall have no obligation under this Warranty whatsoever in any of the cases as set forth below:

- (a) Any defect of the Product caused by freight damage, modification, alteration, abuse, misuse, accident, incorrect installation, disaster, faulty maintenance and/or improper repair by third party other than EIZO and Distributors;
- (b) Any incompatibility of the Product due to possible technical innovations and/or regulations;
- (c) Any deterioration of the sensor;
- (d) Any deterioration of display performance caused by the deterioration of expendable parts such as the LCD panel and/or backlight, etc. (e.g. changes in brightness, changes in brightness uniformity, changes in color, changes in color uniformity, defects in pixels including burnt pixels, etc.);
- (e) Any defect of the Product caused by external equipment;
- (f) Any defect of the Product on which the original serial number has been altered or removed;
- (g) Any normal deterioration of the product, particularly that of consumables, accessories, and/or attachments (e.g. buttons, rotating parts, cables, User’s Manual, etc.); and
- (h) Any deformation, discoloration, and/or warp of the exterior of the product including that of the surface of the LCD panel.

To obtain service under the Warranty, the Original Purchaser must deliver the Product, freight prepaid, in its original package or other adequate package affording an equal degree of protection, assuming the risk of damage and/or loss in transit, to the local Distributor. The Original Purchaser must present proof of purchase of the Product and the date of such purchase when requesting services under the Warranty.

The Warranty Period for any replaced and/or repaired product under this Warranty shall expire at the end of the original Warranty Period.

EIZO OR DISTRIBUTORS ARE NOT RESPONSIBLE FOR ANY DAMAGE TO, OR LOSS OF, DATA OR OTHER INFORMATION STORED IN ANY MEDIA OR ANY PART OF ANY PRODUCT RETURNED TO EIZO OR DISTRIBUTORS FOR REPAIR.

EIZO AND DISTRIBUTORS MAKE NO FURTHER WARRANTIES, EXPRESSED OR IMPLIED, WITH RESPECT TO THE PRODUCT AND ITS QUALITY, PERFORMANCE, MERCHANTABILITY OR FITNESS FOR ANY PARTICULAR USE. IN NO EVENT SHALL EIZO OR DISTRIBUTORS BE LIABLE FOR ANY INCIDENTAL, INDIRECT, SPECIAL, CONSEQUENTIAL OR OTHER DAMAGE WHATSOEVER (INCLUDING, WITHOUT LIMITATION, DAMAGES FOR LOSS OF PROFIT, BUSINESS INTERRUPTION, LOSS OF BUSINESS INFORMATION, OR ANY OTHER PECUNIARY LOSS) ARISING OUT OF THE USE OR INABILITY TO USE THE PRODUCT OR IN ANY CONNECTION WITH THE PRODUCT, WHETHER BASED ON CONTRACT, TORT, NEGLIGENCE, STRICT LIABILITY OR OTHERWISE, EVEN IF EIZO OR DISTRIBUTORS HAVE BEEN ADVISED OF THE POSSIBILITY OF SUCH DAMAGES. THIS EXCLUSION ALSO INCLUDES ANY LIABILITY WHICH MAY ARISE OUT OF THIRD PARTY CLAIMS AGAINST THE ORIGINAL PURCHASER. THE ESSENCE OF THIS PROVISION IS TO LIMIT THE POTENTIAL LIABILITY OF EIZO AND DISTRIBUTORS ARISING OUT OF THIS LIMITED WARRANTY AND/OR SALES.

BEGRENZTE GARANTIE

EIZO Corporation (im Weiteren als „**EIZO**“ bezeichnet) und die Vertragsimporteure von EIZO (im Weiteren als „**Vertrieb(e)**“ bezeichnet) garantieren dem ursprünglichen Käufer (im Weiteren als „**Erstkäufer**“ bezeichnet), der das in diesem Dokument vorgegebene Produkt (im Weiteren als „**Produkt**“ bezeichnet) von EIZO oder einem Vertrieb erworben hat, gemäß den Bedingungen dieser beschränkten Garantie (im Weiteren als „**Garantie**“ bezeichnet), dass EIZO und der Vertrieb nach eigenem Ermessen das Produkt entweder kostenlos reparieren oder austauschen, falls der Erstkäufer innerhalb der Garantiefrist (weiter unten festgelegt) eine Fehlfunktion bzw. Beschädigung des Produkts feststellt, die während des normalen Gebrauchs des Produkts gemäß den Anweisungen des zum Lieferumfang des Produkts gehörenden Benutzerhandbuchs (im Weiteren als „**Benutzerhandbuch**“ bezeichnet) aufgetreten ist.

Die Dauer der Garantieleistung beträgt (i) fünf (5) Jahre ab dem Erstverkaufsdatum des Produkts oder (ii) 30.000 Betriebsstunden des Produkts (im Weiteren als „Garantiefrist“ bezeichnet). EIZO und die Vertriebe übernehmen über den Rahmen dieser Garantie hinaus hinsichtlich des Produkts keinerlei Haftung oder Verpflichtung dem Erstkäufer oder Dritten gegenüber.

Nach Ablauf von sieben (7) Jahren nach Ende der Produktion solcher Teile werden EIZO und Vertriebshändler keine Teile (mit Ausnahme von Konstruktionsteilen) mehr vorhalten und lagern. EIZO und seine Vertriebspartner verpflichten sich, bei einer etwaigen Reparatur des Monitors ausschließlich Produkte gemäß den EIZO-Qualitätssicherungsstandards zu verwenden. Wenn das Gerät aufgrund seines Zustands oder eines Fehlbestands bei einem entsprechenden Teil nicht repariert werden kann, können EIZO und Vertriebshändler statt der Reparatur des Geräts den Austausch gegen ein Produkt mit gleichwertiger Leistung anbieten.

Diese Garantie gilt nur in Ländern oder Gebieten, in denen sich Vertriebe befinden. Die gesetzlichen Gewährleistungsrechte des Erstkäufers gegenüber dem Verkäufer werden durch diese Garantie nicht berührt.

EIZO und die Vertriebe besitzen im Rahmen dieser Garantie keinerlei Verpflichtung in den folgenden Fällen:

- (a) Produktdefekte, die auf Frachtschäden, Modifikation, Nachgestaltung, Missbrauch, Fehlbedienung, Unfälle, unsachgemäße Installation, Naturkatastrophen, fehlerhafte Wartung und/oder unsachgemäße Reparatur durch eine andere Partei als EIZO und die Vertriebe zurückzuführen sind.
- (b) Eine Inkompatibilität des Produkts aufgrund von technischen Neuerungen und/oder neuen Bestimmungen, die nach dem Kauf in Kraft treten.
- (c) Jegliche Verschlechterung des Sensors.
- (d) Jegliche Verschlechterung der Bildschirmleistung, die durch Verschleißteile wie das LCD-Panel und/oder die Hintergrundbeleuchtung usw. hervorgerufen werden (z.B. Veränderungen von Helligkeit oder Helligkeitsverteilung, Veränderungen von Farbe oder Farbverteilung, Pixeldefekte einschließlich von durchgebrannten Pixeln usw.).
- (e) Produktdefekte, die durch externe Geräte verursacht werden.
- (f) Jeglicher Defekt eines Produkts, dessen ursprüngliche Seriennummer geändert oder entfernt wurde.
- (g) Normale Abnutzung des Produkts, insbesondere von Verbrauchsteilen, Zubehörteilen und/oder Beilagen (z.B. Tasten, drehbare Teile, Kabel, Benutzerhandbuch usw.); sowie
- (h) Verformungen, Verfärbungen und/oder Verziehungen am Produktäußeren, einschließlich der Oberfläche des LCD-Panels.

Bei Inanspruchnahme der Garantieleistung ist der Erstkäufer verpflichtet, das Produkt auf eigene Kosten und in der Originalverpackung bzw. einer anderen geeigneten Verpackung, die einen gleichwertigen Schutz gegen Transportschäden bietet, an den örtlichen Vertrieb zu übersenden, wobei der Erstkäufer das Transportrisiko gegenüber Schäden und/oder Verlust trägt. Zum Zeitpunkt der Inanspruchnahme der Garantieleistung muss der Erstkäufer einen Verkaufsbeleg vorweisen, auf dem das Kaufdatum angegeben ist.

Die Garantiefrist für ein im Rahmen dieser Garantie ausgetauschtes und/oder repariertes Produkt erlischt nach Ablauf der ursprünglichen Garantiefrist.

EIZO ODER DIE EIZO-VERTRAGSIMPORTEURE HAFTEN NICHT FÜR ZERSTÖRTE DATENBESTÄNDE ODER DIE KOSTEN DER WIEDERBESCHAFFUNG DIESER DATENBESTÄNDE AUF JEDLICHEN DATENTRÄGERN ODER TEILEN DES PRODUKTS, DIE IM RAHMEN DER GARANTIE BEI EIZO ODER DEN EIZO-VERTRAGSIMPORTEUREN ZUR REPARATUR EINGEREICHT WURDEN.

EIZO UND DIE EIZO-VERTRAGSIMPORTEURE GEBEN WEDER EXPLIZITE NOCH IMPLIZITE GARANTIEEN IN BEZUG AUF DIESES PRODUKT UND SEINE QUALITÄT, LEISTUNG, VERKÄUFLICHKEIT ODER EIGNUNG FÜR EINEN BESTIMMTEN ZWECK. AUF KEINEN FALL SIND EIZO ODER DIE EIZO-VERTRAGSIMPORTEURE VERANTWORTLICH FÜR JEDLICHE ZUFÄLLIGE, INDIREKTE, SPEZIELLE, FOLGE- ODER ANDERE SCHÄDEN JEDLICHER ART (EINSCHLIESSLICH OHNE JEDE BEGRENZUNG SCHÄDEN BEZÜGLICH PROFITVERLUST, GESCHÄFTSUNTERBRECHUNG, VERLUST VON GESCHÄFTSINFORMATION ODER JEDLICHE ANDEREN FINANZIELLEN EINBUSSEN), DIE DURCH DIE VERWENDUNG DES PRODUKTES ODER DIE UNFÄHIGKEIT ZUR VERWENDUNG DES PRODUKTES ODER IN JEDLICHER BEZIEHUNG MIT DEM PRODUKT, SEI ES BASIEREND AUF VERTRAG, SCHADENSERSATZ, NACHLAESSIGKEIT, STRIKTE HAFTPFLICHT ODER ANDEREN FORDERUNGEN ENTSTEHEN, AUCH WENN EIZO UND DIE EIZO-VERTRAGSIMPORTEURE IM VORAUS ÜBER DIE MÖGLICHKEIT SOLCHER SCHÄDEN INFORMIERT WURDEN. DIESER AUSSCHLUSS ENTHÄLT AUCH JEDE HAFTPFLICHT, DIE AUS FORDERUNGEN DRITTER GEGEN DEN ERSTKÄUFER ENTSTEHEN KANN. ZWECK DIESER KLAUSEL IST ES, DIE HAFTUNG VON EIZO UND DEN VERTRIEBEN GEGENÜBER FORDERUNGEN ZU BEGRENZEN, DIE AUS DIESER BESCHRÄNKTEN GARANTIE UND/ODER DEM VERKAUF ENTSTEHEN KÖNNEN.

GARANTIE LIMITÉE

EIZO Corporation (ci-après dénommé « **EIZO** ») et les distributeurs autorisés par EIZO (ci-après dénommés « **Distributeurs** »), sous réserve et conformément aux termes de cette garantie limitée (ci-après dénommée « **Garantie** »), garantissent à l'acheteur initial (ci-après dénommé « **Acheteur initial** ») du produit spécifié dans la présente (ci-après dénommé « **Produit** ») acheté auprès d'EIZO ou de Distributeurs agréés EIZO, que EIZO et ses Distributeurs auront pour option de réparer ou remplacer gratuitement le Produit si l'Acheteur initial constate, pendant la Période de garantie (définie ci-dessous), qu'il y a un dysfonctionnement ou que le Produit a subi un dommage dans le cadre d'une utilisation normale du Produit conformément à la description du mode d'emploi qui accompagne le Produit (ci-après dénommé « **Manuel d'utilisation** »).

La période de cette Garantie est limitée à (i) cinq (5) ans à partir de la date d'achat du Produit ; ou, limitée jusqu'à l'expiration de (ii) 30 000 heures d'utilisation du Produit (ci-après dénommée « **Période de Garantie** »). EIZO et ses Distributeurs déclinent toute responsabilité ou obligation concernant ce Produit face à l'Acheteur initial ou à toute autre personne à l'exception de celles stipulées dans la présente Garantie.

EIZO et ses Distributeurs cesseront de conserver ou de stocker des pièces (à l'exception des pièces de conception) du Produit à l'expiration d'une période de sept (7) ans après l'arrêt de la production de ces pièces. Pour réparer le moniteur, EIZO et ses distributeurs utiliseront des pièces de rechange conformes à nos normes de contrôle qualité. Si l'unité ne peut pas être réparée en raison de son état ou de la rupture de stock d'une pièce adéquate, EIZO et ses Distributeurs peuvent proposer le remplacement par un produit aux performances équivalentes au lieu de le réparer.

La Garantie est valable uniquement dans les pays ou les territoires où se trouvent les Distributeurs. La Garantie ne limite aucun des droits reconnus par la loi à l'Acheteur initial.

Nonobstant toute autre clause de cette Garantie, EIZO et ses Distributeurs n'auront d'obligation dans le cadre de cette Garantie pour aucun des cas énumérés ci-dessous :

- (a) Tout défaut du Produit résultant de dommages occasionnés lors du transport, d'une modification, d'une altération, d'un abus, d'une mauvaise utilisation, d'un accident, d'une installation incorrecte, d'un désastre, d'un entretien et/ou d'une réparation incorrects effectués par une personne autre que EIZO ou ses Distributeurs ;
- (b) Toute incompatibilité du Produit résultant d'améliorations techniques et/ou réglementations possibles ;
- (c) Toute détérioration du capteur ;
- (d) Toute détérioration des performances d'affichage causée par la détérioration des éléments consommables tels que le panneau LCD et/ou le rétroéclairage, etc. (par exemple des changements de luminosité, des changements de l'uniformité de la luminosité, des modifications de couleur, des changements de l'uniformité des couleurs, des défauts de pixels y compris des pixels brûlés, etc.);
- (e) Tout défaut du Produit causé par un appareil externe ;
- (f) Tout défaut d'un Produit sur lequel le numéro de série original a été altéré ou supprimé ;
- (g) Toute détérioration normale du Produit, particulièrement celle des consommables, des accessoires et/ou des pièces reliées au Produit (touches, éléments pivotants, câbles, Manuel d'utilisation etc.), et
- (h) Toute déformation, décoloration, et/ou gondolage de l'extérieur du Produit, y compris celle de la surface du panneau LCD.

Pour bénéficier d'un service dans le cadre de cette Garantie, l'Acheteur initial doit renvoyer le Produit port payé, dans son emballage d'origine ou tout autre emballage approprié offrant un degré de protection équivalent, au Distributeur local, et assumera la responsabilité des dommages et/ou perte possibles lors du transport. L'Acheteur initial doit présenter une preuve d'achat du Produit comprenant sa date d'achat pour bénéficier de ce service dans le cadre de la Garantie.

La Période de garantie pour tout Produit remplacé et/ou réparé dans le cadre de cette Garantie expirera à la fin de la Période de garantie initiale.

EIZO OU SES DISTRIBUTEURS NE SAURAIENT ÊTRE TENUS RESPONSABLES DES DOMMAGES OU PERTES DE DONNÉES OU D'AUTRES INFORMATIONS STOCKÉES DANS UN MÉDIA QUELCONQUE OU UNE AUTRE PARTIE DU PRODUIT RENVOYÉ À EIZO OU AUX DISTRIBUTEURS POUR RÉPARATION.

AUCUNE AUTRE GARANTIE, EXPLICITE OU TACITE, N'EST OFFERTE PAR EIZO ET SES DISTRIBUTEURS CONCERNANT LE PRODUIT ET SES QUALITÉS, PERFORMANCES, QUALITÉ MARCHANDE OU ADAPTATION À UN USAGE PARTICULIER. EN AUCUN CAS, EIZO OU SES DISTRIBUTEURS NE SERONT RESPONSABLES DES DOMMAGES FORTUITS, INDIRECTS, SPÉCIAUX, INDUITS, OU DE TOUT AUTRE DOMMAGE QUEL QU'IL SOIT (Y COMPRIS, SANS LIMITATION, LES DOMMAGES RÉSULTANT D'UNE PERTE DE PROFIT, D'UNE INTERRUPTION D'ACTIVITÉS, D'UNE PERTE DE DONNÉES COMMERCIALES, OU DE TOUT AUTRE MANQUE À GAGNER) RÉSULTANT DE L'UTILISATION OU DE L'INCAPACITÉ D'UTILISER LE PRODUIT OU AYANT UN RAPPORT QUELCONQUE AVEC LE PRODUIT, QUE CE SOIT SUR LA BASE D'UN CONTRAT, D'UN TORT, D'UNE NÉGLIGENCE, D'UNE RESPONSABILITÉ STRICTE OU AUTRE, MÊME SI EIZO OU SES DISTRIBUTEURS ONT ÉTÉ AVERTIS DE LA POSSIBILITÉ DE TELS DOMMAGES. CETTE LIMITATION INCLUT AUSSI TOUTE RESPONSABILITÉ QUI POURRAIT ÊTRE SOULEVÉE LORS DES RÉCLAMATIONS D'UN TIERS CONTRE L'ACHETEUR INITIAL. L'ESSENCE DE CETTE CLAUSE EST DE LIMITER LA RESPONSABILITÉ POTENTIELLE DE EIZO ET DE SES DISTRIBUTEURS RÉSULTANT DE CETTE GARANTIE LIMITÉE ET/OU DES VENTES.

GARANTÍA LIMITADA

EIZO Corporation (en lo sucesivo “EIZO”) y sus distribuidores autorizados (en lo sucesivo los “Distribuidores”), con arreglo y de conformidad con los términos de esta garantía limitada (en lo sucesivo la “Garantía”), garantizan al comprador original (en lo sucesivo el “Comprador original”) que compró el producto especificado en este documento (en lo sucesivo el “Producto”) a EIZO o a sus Distribuidores, que EIZO y sus Distribuidores, a su propio criterio, repararán o sustituirán el Producto de forma gratuita si el Comprador original detecta dentro del periodo de la Garantía (indicado posteriormente) que el Producto no funciona correctamente o que se ha averiado durante el uso normal del mismo de acuerdo con las indicaciones del manual de instrucciones suministrado con el Producto (en lo sucesivo el “Manual del usuario”).

El periodo de validez de esta Garantía está limitado a (i) cinco (5) años a partir de la fecha de compra del Producto o (ii) a 30.000 horas de uso del Producto (en adelante designado como el “Periodo de Garantía”). EIZO y sus Distribuidores no tendrán ninguna responsabilidad ni obligación con respecto al Producto para con el Comprador original ni para con terceros que no sean las estipuladas en la presente Garantía.

EIZO y sus distribuidores dejarán de tener o almacenar cualquier pieza del producto (excepto piezas del diseño) una vez expirado el periodo de siete (7) años después de que hayan dejado de fabricarse tales piezas. Para la reparación del monitor, EIZO y los distribuidores utilizarán repuestos que cumplan con nuestros estándares de control de calidad. Si no se puede reparar la unidad debido a su estado o si se han agotado las existencias de una pieza importante, EIZO y sus distribuidores podrán ofrecerle sustituirlo por un producto con rendimiento equivalente en lugar de repararlo.

La Garantía es válida sólo en los países y territorios donde están ubicados los Distribuidores. La Garantía no restringe ningún derecho legal del Comprador original.

A pesar de las estipulaciones de esta Garantía, EIZO y sus Distribuidores no tendrán obligación alguna bajo esta Garantía en ninguno de los casos expuestos a continuación:

- (a) Cualquier defecto del Producto causado por daños en el transporte, modificación, alteración, abuso, uso incorrecto, accidente, instalación incorrecta, desastre, mantenimiento incorrecto y/o reparación indebida realizada por un tercero que no sea EIZO o sus Distribuidores.
- (b) Cualquier incompatibilidad del Producto debida a posibles innovaciones técnicas y/o reglamentaciones.
- (c) Cualquier deterioro del sensor.
- (d) Cualquier deterioro en el rendimiento de la visualización causado por fallos en las piezas consumibles como el panel LCD y/o la "Backlight", etc. (p. ej. cambios de brillo, cambios de uniformidad del brillo, cambios de color, cambios de uniformidad del color, defectos de píxeles, incluyendo píxeles muertos, etc.).
- (e) Cualquier defecto del Producto causado por un equipo externo.
- (f) Cualquier defecto del Producto en el que haya sido alterado o borrado el número de serie original.
- (g) Cualquier deterioro normal del Producto, y en particular de las piezas consumibles, accesorios y demás (p. ej. botones, piezas giratorias, cables, Manual del usuario, etc.).
- (h) Cualquier deformación, decoloración y/o alabeo del exterior del Producto incluida la superficie del panel LCD.

Para obtener servicio en los términos de esta Garantía, el Producto deberá ser enviado por el Comprador original, a su Distribuidor local, con el transporte previamente pagado, en el embalaje original u otro embalaje adecuado que ofrezca el mismo grado de protección, asumiendo el riesgo de daños y/o pérdida del Producto durante el transporte. El Comprador original deberá presentar un comprobante de compra del Producto en el que se refleje la fecha de compra del mismo cuando lo solicite el servicio de Garantía.

El Periodo de garantía para cualquier Producto reemplazado y/o reparado en los términos de esta Garantía expirará al vencer el Periodo de garantía original.

EIZO O LOS DISTRIBUIDORES AUTORIZADOS DE EIZO NO SE RESPONSABILIZAN DE NINGÚN DAÑO O PÉRDIDA QUE PUEDAN SUFRIR LOS DATOS U OTRA INFORMACIÓN ALMACENADA EN CUALQUIER MEDIO O CUALQUIER PARTE DE CUALQUIER PRODUCTO DEVUELTO A EIZO O A LOS DISTRIBUIDORES DE EIZO PARA SU REPARACIÓN.

EIZO Y LOS DISTRIBUIDORES AUTORIZADOS DE EIZO NO OFRECEN NINGUNA OTRA GARANTÍA, IMPLÍCITA NI EXPLÍCITA, CON RESPECTO AL PRODUCTO Y A SU CALIDAD, RENDIMIENTO, COMERCIABILIDAD E IDONEIDAD PARA CUALQUIER USO EN PARTICULAR. EN NINGÚN CASO SERÁN EIZO O LOS DISTRIBUIDORES AUTORIZADOS DE EIZO RESPONSABLES DE NINGÚN DAÑO EMERGENTE, INDIRECTO, ESPECIAL, INHERENTE O CUALQUIERA QUE SEA (INCLUYENDO, SIN LIMITACIÓN, DAÑOS POR LUCRO CESANTE, INTERRUPCIÓN DE LA ACTIVIDAD COMERCIAL, PÉRDIDA DE INFORMACIÓN COMERCIAL O CUALQUIER OTRA PÉRDIDA PECUNIARIA) QUE SE DERIVE DEL USO O IMPOSIBILIDAD DE USO DEL PRODUCTO O EN RELACIÓN CON EL PRODUCTO, YA SEA BASADO EN CONTRATO, POR AGRAVIO, NEGLIGENCIA, ESTRICTA RESPONSABILIDAD O CUALQUIERA QUE SEA, AUN CUANDO SE HAYA ADVERTIDO A EIZO O A LOS DISTRIBUIDORES DE EIZO DE LA POSIBILIDAD DE TALES DAÑOS. ESTA EXCLUSIÓN TAMBIÉN ABARCA CUALQUIER RESPONSABILIDAD QUE PUEDA DERIVARSE DE RECLAMACIONES HECHAS POR UN TERCERO CONTRA EL COMPRADOR ORIGINAL. LA ESENCIA DE ESTA ESTIPULACIÓN ES LIMITAR LA RESPONSABILIDAD POTENCIAL DE EIZO Y LOS DISTRIBUIDORES QUE PUDIERA DERIVARSE DE ESTA GARANTÍA LIMITADA Y/O VENTAS.

GARANZIA LIMITATA

EIZO Corporation (a cui si farà riferimento da qui in poi con “**EIZO**”) ed i Distributori autorizzati da EIZO (a cui si farà riferimento da qui in poi con “**Distributori**”) garantiscono, secondo i termini di questa garanzia limitata (a cui si farà riferimento da qui in poi con “**Garanzia**”) all’acquirente originale (a cui si farà riferimento da qui in poi con “**Acquirente originale**”) che ha acquistato il prodotto specificato in questo documento (a cui si farà riferimento da qui in poi con “**Prodotto**”) da EIZO o dai suoi Distributori, che EIZO e i distributori, a loro discrezione, ripareranno o sostituiranno il Prodotto senza addebito se l’Acquirente originale trova, entro il periodo della Garanzia (definito sotto), che il Prodotto malfunziona e si è danneggiato nel corso del suo normale utilizzo osservando le indicazioni del manuale di istruzioni allegato al Prodotto (a cui si farà riferimento da qui in poi con “**Manuale utente**”).

La presente Garanzia è limitata a (i) cinque (5) anni a partire dalla data d’acquisto del Prodotto o (ii) allo scadere di 30.000 ore d’utilizzo del Prodotto (a cui si farà riferimento da qui in poi con “**Periodo di Garanzia**”). EIZO e i suoi Distributori non si assumono alcuna responsabilità e non hanno alcun obbligo riguardo al Prodotto verso l’Acquirente originale o terzi diversi da quelli relativi a questa Garanzia.

EIZO e i distributori cesseranno lo stoccaggio dei componenti (tranne le parti relative al progetto) del prodotto dopo sette (7) anni dall’interruzione della produzione di tali componenti. Per la riparazione del monitor, EIZO e i Distributori utilizzeranno parti di ricambio conformi ai nostri standard di controllo della qualità. Se l’unità non può essere riparata a causa delle sue condizioni o dell’esaurimento scorte di un componente rilevante, EIZO e i distributori potrebbero offrire la sostituzione con un prodotto con prestazioni equivalenti piuttosto ripararlo.

La Garanzia è valida soltanto nei paesi dove ci sono i Distributori EIZO. La Garanzia non limita alcun diritto legale dell’Acquirente originale.

Indipendentemente da qualsiasi altra condizione di questa Garanzia, EIZO e i suoi Distributori non avranno alcun obbligo derivante da questa Garanzia in ognuno dei casi elencati di seguito:

- (a) Qualsiasi difetto del Prodotto causato da danni di trasporto, modifiche, alterazioni, abusi, usi impropri, incidenti, installazione errata, calamità, manutenzione errata e/o riparazioni improprie eseguite da terze parti che non siano EIZO o i suoi Distributori.
- (b) Qualsiasi incompatibilità del Prodotto dovuta a possibili innovazioni tecniche e/o normative.
- (c) Qualsiasi deterioramento del sensore.
- (d) Qualsiasi deterioramento delle prestazioni dello schermo causato dal deterioramento delle parti consumabili, come il pannello LCD e/o la retroilluminazione, ecc. (per esempio: i cambiamenti di luminosità, cambiamenti di uniformità della luminosità, i cambiamenti di colore, i cambiamenti di uniformità del colore, i difetti dei pixel, inclusi i pixel bruciati, ecc.).
- (e) Qualsiasi difetto del Prodotto causato da apparecchiature esterne.
- (f) Qualsiasi difetto del Prodotto in cui il numero di serie originale sia stato alterato o rimosso.
- (g) Qualsiasi normale deterioramento del Prodotto, in particolar modo nelle sue parti di consumo, accessori, e/o attacchi (per esempio: tasti, parti rotanti, cavi, Manuale dell’utente, ecc.).
- (h) Qualsiasi tipo di deformazione, scolorimento, e/o di involucro esterno del Prodotto inclusa la superficie del pannello LCD.

Per ricevere assistenza tecnica con questa Garanzia, l’Acquirente originale deve inviare il Prodotto, con trasporto pre-pagato, nella sua confezione originale o altra confezione adeguata che fornisce un livello analogo di protezione, assumendosi il rischio di danni e/o perdita in transito, al Distributore locale. L’Acquirente originale deve presentare la prova di acquisto che stabilisce la data di acquisto del Prodotto quando richiede servizio sotto Garanzia.

Il Periodo di garanzia per qualsiasi Prodotto sostituito e/o riparato sotto questa Garanzia scade alla fine del Periodo di garanzia originale.

EIZO O I SUOI DISTRIBUTORI NON SONO RESPONSABILI PER QUALSIASI DANNO O PERDITA DI DATI O ALTRE INFORMAZIONI MEMORIZZATI SU QUALSIASI SUPPORTO O QUALSIASI PARTE DI QUALSIASI PRODOTTO INVIATO A EIZO O I SUOI DISTRIBUTORI PER RIPARAZIONI.

EIZO E I SUOI DISTRIBUTORI NON OFFRONO ALCUNA GARANZIA ADDIZIONALE, IMPLICITA O ESPLICITA, RIGUARDO IL PRODOTTO E LA SUA QUALITÀ, PRESTAZIONI, VENDIBILITÀ O APPROPRIATEZZA PER QUALSIASI USO PARTICOLARE. IN NESSUN CASO EIZO O I DISTRIBUTORI EIZO AUTORIZZATI SARANNO RESPONSABILI PER QUALSIASI DANNO ACCIDENTALE, INDIRECTO, SPECIALE, CONSEGUENTE O DI QUALSIASI ALTRA NATURA (INCLUSI, SENZA LIMITI, DANNI PER PERDITA DI PROFITTI, INTERRUZIONE DELLE ATTIVITÀ, PERDITA DI INFORMAZIONI D’AFFARI O QUALSIASI ALTRA PERDITA PECUNIARIA) DERIVANTI DALL’USO O DALL’IMPOSSIBILITÀ DI USARE IL PRODOTTO O IN QUALSIASI RELAZIONE AL PRODOTTO, SIA SU BASE DI CONTRATTO, TORTO, NEGLIGENZA, STRETTA RESPONSABILITÀ O ALTRIMENTI, ANCHE SE EIZO O I DISTRIBUTORI EIZO AUTORIZZATI SONO STATI AVVERTITI DELLA POSSIBILITÀ DI TALI DANNI. QUESTA ESCLUSIONE INCLUDE ANCHE QUALSIASI RESPONSABILITÀ CHE POSSA INSORGERE DA RECLAMI DI TERZI CONTRO L’ACQUIRENTE ORIGINALE. L’ESSENZA DI QUESTO PROVVEDIMENTO È LIMITARE LA RESPONSABILITÀ POTENZIALE DI EIZO E DEI DISTRIBUTORI DERIVANTE DA QUESTA GARANZIA LIMITATA E/O DALLE VENDITE.

BEGRÄNSAD GARANTI

EIZO Corporation (nedan kallat "**EIZO**") och EIZOs auktoriserade distributörer (nedan kallade "**Distributörer**") garanterar i enlighet med villkoren i denna begränsade garanti (nedan kallad "**Garantin**") den ursprunglige köparen (nedan kallad den "**Ursprunglige köparen**") som köpte den i dokumentet specificerade produkten (nedan kallad "**Produkten**") från EIZO eller Distributörer, att EIZO eller Distributörer enligt eget gottfinnande kostnadsfritt antingen reparera eller byta ut den defekta Produkten om den Ursprunglige köparen inom Garantiperioden (definieras nedan) upptäcker att Produkten fungerar felaktigt eller skadas under normal användning av Produkten i enlighet med beskrivningen i bruksanvisningen (nedan kallad "**Bruksanvisning**").

Giltighetsperioden för denna garanti är begränsad till (i) fem (5) år från datumet för Produktens inköp eller, om detta inträffar tidigare, begränsat till utlöpanget av (ii) 30 000 timmars användning av Produkten (häri kallad "**Garantiperioden**"). EIZO och Distributörer ska inte under några villkor ha något annat ansvar än vad som anges i denna garanti gällande Produkten i relation till den Ursprunglige köparen eller tredje part.

EIZO och dess leverantörer slutar lagerföra delar (utom designdelar) till produkten sju (7) år efter att delen i fråga slutar tillverkas. Nät skärmen repareras använder EIZO och distributörer reservdelar som uppfyller våra kvalitetsstandarder. Om enheten inte kan repareras på grund av skicket eller att en del inte finns i lager kan EIZO och dess leverantörer erbjuda sig att byta ut produkten mot en produkt med likvärdig prestanda istället för att reparera den.

Garantin är endast giltig i de länder där det finns Distributörer. Garantin begränsar inte några av den Ursprunglige köparens lagstadgade rättigheter.

Oavsett andra villkor i denna garanti ska inte EIZO Distributörer under några villkor ha något ansvar i något av de fall som beskrivs nedan:

- (a) När någon bristfällighet hos Produkten kan härledas till att ha uppstått vid frakt, modifiering, ändring, felaktigt handhavande, olycka, felaktig installation, katastrof, felaktigt underhåll och/eller felaktig reparation utförd av tredje part annan än EIZO och Distributörer.
- (b) Alla former av inkompatibilitet hos Produkten på grund av möjliga tekniska innovationer och/eller bestämmelser.
- (c) Alla försämringar av sensorn.
- (d) Alla försämringar av bildens prestanda beroende på förbrukningsdelar så som LCD-panel och/eller bakgrundsbelysning etc. (t.ex. ändringar i ljusstyrka, jämnhet i ljusstyrka, färg, färgjämnhet, defekta pixlar och/eller fast lysande pixlar etc.).
- (e) Alla defekter hos Produkten som orsakats av extern utrustning.
- (f) Alla defekter hos Produkten på vilken det ursprungliga serienumret har ändrats eller avlägsnats.
- (g) All normal försämring av Produkten, speciellt förbrukningsartiklar, tillbehör och/eller yttre delar (t.ex. knappar, roterande delar, kablar, Bruksanvisningen etc.).
- (h) Varje deformation, missfärgning och/eller skevhet av Produktens yttre inklusive ytan på LCD-panelen.

För att erhålla service under denna garanti måste den Ursprunglige köparen (med hänseende till risken för skada och/eller förlust under transport) leverera Produkten till närmaste Distributör med förebetalad frakt, i dess ursprungliga förpackning eller annan fullgod förpackning som ger likvärdigt skydd. Den Ursprunglige köparen måste kunna visa inköpsbevis för Produkten som klargör Produktens inköpsdatum vid begäran av garantiservice.

Garantiperioden för alla utbytta och/eller reparerade produkter under denna garanti skall upphöra vid utgången av den ursprungliga Garantiperioden.

EIZO ELLER DISTRIBUTÖRER ÄR INTE ANSVARIGA FÖR NÅGON FORM AV SKADA ELLER FÖRLUST AV DATA ELLER ANNAN INFORMATION SOM HAR LAGRATS I NÅGON FORM AV MEDIA ELLER ANNAN DEL AV NÅGON PRODUKT SOM HAR RETURNERATS TILL EIZO ELLER DISTRIBUTÖRER FÖR REPARATION.

EIZO OCH DISTRIBUTÖRERNA GARANTERAR INGET, UTTRYCKLIGEN ELLER UNDERFÖRSTÅTT, VAD BETRÄFFAR PRODUKTEN OCH DESS KVALITET, PRESTANDA, SÄLJBARHET ELLER LÄMPLIGHET FÖR NÅGON FORM AV SPECIELL ANVÄNDNING. UNDER INGA OMSTÄNDIGHETER SKALL EIZO ELLER DISTRIBUTÖRERNA HÅLLAS ANSVARIGA FÖR NÅGRA SOM HELST UNDERORDNADE, INDIREKTA, SPECIELLA, DÄRAV FÖLJANDE ELLER ÖVRIGA SKADOR (INKLUSIVE, UTAN BEGRÄNSNING TILL, SKADOR FÖR FÖRLUST AV INKOMST, AVBRUTEN AFFÄRSRÖRELSE, FÖRLUST AV AFFÄRSINFORMATION ELLER ANNAN SÄRSKILD FÖRLUST) SOM UPPSTÅTT SOM ETT RESULTAT AV ANVÄNDNING ELLER OFÖRMÅGA ATT ANVÄNDA PRODUKTEN ELLER I NÅGON FORM AV ANSLUTNING TILL PRODUKTERNA, VARE SIG DETTA GRUNDAS PÅ KONTRAKT, ÅTALBAR HANDLING, FÖRSUMLIGHET, ANSVARSSKYLDIGHET ELLER ANNAT, ÄVEN OM EIZO ELLER DISTRIBUTÖRERNA HAR INFORMERATS BETRÄFFANDE MÖJLIGHET ATT SÅDANA SKADOR FÖRELIGGER. DETTA UNDANTAG OMFATTAR ÄVEN ALL FORM AV ANSVARSSKYLDIGHET SOM KAN UPPSTÅ GENOM EN TREDJE PARTS ANSPRÅK GEMENSAMT DEN URSPRUNGLIGE KÖPAREN. GRUNDBESTÄNDSDELEN I BESTÄMMELESEN ÄR ATT BEGRÄNSA DET EVENTUELLA ANSVARSTAGANDET FÖR EIZO OCH DISTRIBUTÖRERNA SOM KAN UPPSTÅ GENOM DENNA BEGRÄNSADE GARANTI OCH/ELLER FÖRSÄLJNING.

ΠΕΡΙΟΡΙΣΜΕΝΗ ΕΓΓΥΗΣΗ

Η EIZO Corporation (στο εξής «**EIZO**») και οι διανομείς που εξουσιοδοτεί η EIZO (στο εξής «**Διανομείς**») παρέχουν εγγύηση, υποκείμενη και σύμφωνα με τους όρους της παρούσας περιορισμένης εγγύησης (στο εξής «**Εγγύηση**»), στον αρχικό αγοραστή (στο εξής «**Αρχικός Αγοραστής**») ο οποίος αγόρασε το προϊόν που καθορίζεται στο παρόν έγγραφο (στο εξής «**Προϊόν**») από την EIZO ή τους Διανομείς, η οποία εξασφαλίζει ότι η EIZO και οι Διανομείς, σύμφωνα με τη διακριτή ευχέρειά τους, είτε θα επισκευάσουν είτε θα αντικαταστήσουν το Προϊόν χωρίς χρέωση εάν ο Αρχικός Αγοραστής αντιληφθεί εντός της Περιόδου Εγγύησης (ορίζεται κατωτέρω) ότι το Προϊόν δυσλειτουργεί ή έχει υποστεί βλάβη κατά τη διάρκεια κανονικής χρήσης του Προϊόντος σύμφωνα με την περιγραφή στο εγχειρίδιο χρήσης που συνοδεύει το Προϊόν (στο εξής «**Εγχειρίδιο Χρήστη**»).

Η περίοδος της παρούσας Εγγύησης είναι (i) πέντε (5) έτη από την ημερομηνία αγοράς του Προϊόντος, ή, στη λήξη των (ii) 30.000 ωρών χρήσης του Προϊόντος (στο εξής «**Περίοδος Εγγύησης**»). Η EIZO και οι Διανομείς δεν φέρουν καμία ευθύνη ή υποχρέωση όσον αφορά το Προϊόν σε σχέση με τον Αρχικό Αγοραστή ή οποιοδήποτε τρίτο μέρος, ούτε άλλη ευθύνη διαφορετική από αυτήν που παρέχεται στην παρούσα Εγγύηση.

Η EIZO και οι διανομείς της θα πάψουν να διατηρούν αποθέματα εξαρτημάτων (εκτός από τα εξαρτήματα σχεδιασμού) του προϊόντος μόλις περάσουν επτά (7) χρόνια αφότου διακοπεί η παραγωγή των εν λόγω εξαρτημάτων. Κατά την επισκευή της οθόνης, η EIZO και οι Διανομείς θα χρησιμοποιήσουν ανταλλακτικά επισκευής που συμμορφώνονται με τα πρότυπά μας για τη Διασφάλιση Ποιότητας. Αν δεν είναι εφικτή η επισκευή της μονάδας λόγω της κατάστασής της ή λόγω έλλειψης αποθεμάτων κάποιου σχετικού εξαρτήματος, η EIZO και οι διανομείς της ενδέχεται να σας προσφέρουν τη δυνατότητα αντικατάστασής της με προϊόν ισοδύναμων επιδόσεων αντί να την επισκευάσουν.

Η Εγγύηση ισχύει μόνο σε χώρες ή περιοχές όπου βρίσκονται οι Διανομείς. Η Εγγύηση δεν περιορίζει οποιαδήποτε νόμιμα δικαιώματα του Αρχικού Αγοραστή.

Λαμβανομένης υπόψη κάθε διάταξης της παρούσας Εγγύησης, η EIZO και οι Διανομείς δεν θα έχουν καμία απολύτως υποχρέωση σύμφωνα με την παρούσα Εγγύηση σε οποιαδήποτε από τις περιπτώσεις που διατυπώνονται κατωτέρω:

- (α) Τυχόν ελάττωμα του Προϊόντος που προκαλείται από ζημία κατά τη μεταφορά, τροποποίηση, αλλαγή, κατάχρηση, λανθασμένη χρήση, ατύχημα, λανθασμένη εγκατάσταση, καταστροφή, εσφαλμένη συντήρηση ή/και λανθασμένη επισκευή από τρίτο μέρος εκτός της EIZO και των Διανομέων,
- (β) Τυχόν ασυμβατότητα του Προϊόντος λόγω πιθανών τεχνικών καινοτομιών ή/και κανονισμών,
- (γ) Τυχόν επιδείνωση του αισθητήρα,
- (δ) Τυχόν επιδείνωση της απόδοσης οθόνης που προκαλείται από τη φθορά αναλώσιμων εξαρτημάτων όπως της οθόνης LCD ή/και του φωτός υποβάθρου, κτλ. (π.χ. αλλαγές στη φωτεινότητα, αλλαγές στην ομοιομορφία φωτεινότητας, αλλαγές στο χρώμα, αλλαγές στην ομοιομορφία χρώματος, ελαττώματα σε pixel περιλαμβανομένων των καμένων pixel, κτλ.),
- (ε) Τυχόν ελάττωμα του Προϊόντος που προκαλείται από εξωτερικό εξοπλισμό,
- (στ) Τυχόν ελάττωμα του Προϊόντος στο οποίο έχει τροποποιηθεί ή αφαιρεθεί ο γνήσιος αριθμός σειράς,
- (ζ) Τυχόν φυσιολογική φθορά του προϊόντος, ιδιαίτερα αυτής των αναλώσιμων, των αξεσουάρ ή/και των προσαρτημάτων (π.χ. κουμπιά, περιστρεφόμενα μέρη, καλώδια, Εγχειρίδιο Χρήστη, κτλ.), και
- (η) Τυχόν παραμόρφωση, αποχρωματισμό ή/και διαστρέβλωση του εξωτερικού μέρους του προϊόντος, περιλαμβανομένης της επιφάνειας της οθόνης LCD.

Ο Αρχικός Αγοραστής για να δικαιούται υπηρεσίες επισκευής σύμφωνα με την Εγγύηση, θα πρέπει να παραδώσει το Προϊόν, με πληρωμένα τα μεταφορικά έξοδα, στην αρχική του συσκευασία ή σε άλλη επαρκή συσκευασία με ισότιμο βαθμό προστασίας, αναλαμβάνοντας τον κίνδυνο βλάβης ή/και απώλειας κατά τη μεταφορά, στον τοπικό Διανομέα. Ο Αρχικός Αγοραστής όταν ζητά υπηρεσίες επισκευής σύμφωνα με την Εγγύηση, θα πρέπει να προσκομίζει την απόδειξη αγοράς του Προϊόντος και την ημερομηνία της αγοράς.

Η Περίοδος Εγγύησης για οποιοδήποτε αντικατεστημένο ή/και επισκευασμένο προϊόν σύμφωνα με την παρούσα Εγγύηση λήγει στο τέλος της αρχικής Περιόδου Εγγύησης.

Η EIZO Ή ΟΙ ΔΙΑΝΟΜΕΙΣ ΔΕΝ ΕΥΘΥΝΟΝΤΑΙ ΓΙΑ ΟΠΟΙΟΔΗΠΟΤΕ ΒΛΑΒΗ Ή ΑΠΩΛΕΙΑ ΔΕΔΟΜΕΝΩΝ Ή ΑΛΛΩΝ ΠΛΗΡΟΦΟΡΙΩΝ ΠΟΥ ΑΠΟΘΗΚΕΥΟΝΤΑΙ ΣΕ ΟΠΟΙΟΔΗΠΟΤΕ ΜΕΣΟ Ή ΟΠΟΙΟΔΗΠΟΤΕ ΑΛΛΟ ΜΕΡΟΣ ΣΕ ΟΠΟΙΟΔΗΠΟΤΕ ΠΡΟΪΟΝ ΠΟΥ ΕΠΙΣΤΡΕΦΕΤΑΙ ΣΤΗΝ EIZO Ή ΣΕ ΔΙΑΝΟΜΕΑ ΓΙΑ ΕΠΙΣΚΕΥΗ.

Η EIZO ΚΑΙ ΟΙ ΔΙΑΝΟΜΕΙΣ ΔΕΝ ΠΑΡΕΧΟΥΝ ΚΑΜΙΑ ΠΕΡΑΙΤΕΡΩ ΕΓΓΥΗΣΗ, ΡΗΤΗ Ή ΣΥΝΕΠΑΓΟΜΕΝΗ, ΟΣΟΝ ΑΦΟΡΑ ΤΟ ΠΡΟΪΟΝ ΚΑΙ ΤΗΝ ΠΟΙΟΤΗΤΑ, ΤΗΝ ΑΠΟΔΟΣΗ, ΤΗΝ ΕΜΠΟΡΕΥΣΙΜΟΤΗΤΑ Ή ΤΗΝ ΚΑΤΑΛΛΗΛΟΤΗΤΑ ΤΟΥ ΓΙΑ ΟΠΟΙΟΔΗΠΟΤΕ ΣΥΓΚΕΚΡΙΜΕΝΗ ΧΡΗΣΗ. ΣΕ ΚΑΜΙΑ ΠΕΡΙΠΤΩΣΗ Η EIZO Ή ΟΙ ΔΙΑΝΟΜΕΙΣ ΔΕΝ ΘΑ ΕΥΘΥΝΟΝΤΑΙ ΓΙΑ ΚΑΜΙΑ ΑΠΟΛΥΤΩΣ ΤΥΧΑΙΑ, ΕΜΜΕΣΗ, ΕΙΔΙΚΗ, ΣΥΝΕΠΑΓΟΜΕΝΗ Ή ΑΛΛΗ ΒΛΑΒΗ (ΠΕΡΙΛΑΜΒΑΝΟΜΕΝΩΝ, ΜΕΤΑΞΥ ΑΛΛΩΝ, ΒΛΑΒΩΝ Ή ΑΠΩΛΕΙΑΣ ΚΕΡΔΩΝ, ΔΙΑΚΟΠΗΣ ΕΠΙΧΕΙΡΗΜΑΤΙΚΩΝ ΔΡΑΣΤΗΡΙΟΤΗΤΩΝ, ΑΠΩΛΕΙΑΣ ΕΠΙΧΕΙΡΗΜΑΤΙΚΩΝ ΠΛΗΡΟΦΟΡΙΩΝ Ή ΤΥΧΟΝ ΑΛΛΗΣ ΧΡΗΜΑΤΙΚΗΣ ΑΠΩΛΕΙΑΣ) ΠΟΥ ΠΡΟΚΥΠΤΕΙ ΑΠΟ ΤΗ ΧΡΗΣΗ Ή ΤΗΝ ΑΝΙΚΑΝΟΤΗΤΑ ΧΡΗΣΗΣ ΤΟΥ ΠΡΟΪΟΝΤΟΣ Ή ΤΥΧΟΝ ΑΛΛΗΣ ΣΥΝΔΕΣΗΣ ΜΕ ΤΟ ΠΡΟΪΟΝ, ΕΙΤΕ ΒΑΣΙΖΕΤΑΙ ΣΕ ΣΥΜΒΟΛΑΙΟ, ΒΛΑΒΗ, ΑΜΕΛΕΙΑ, ΑΥΣΤΗΡΗ ΕΥΘΥΝΗ Ή ΕΙΔΑΛΛΩΣ, ΑΚΟΜΗ ΚΙ ΕΑΝ Η EIZO Ή ΟΙ ΔΙΑΝΟΜΕΙΣ ΕΝΗΜΕΡΩΘΟΥΝ ΓΙΑ ΤΗΝ ΠΙΘΑΝΟΤΗΤΑ ΤΕΤΟΙΩΝ ΖΗΜΙΩΝ. Η ΕΞΑΙΡΕΣΗ ΑΥΤΗ ΠΕΡΙΛΑΜΒΑΝΕΙ ΕΠΙΣΗΣ ΟΠΟΙΟΔΗΠΟΤΕ ΕΥΘΥΝΗ ΕΝΔΕΧΕΤΑΙ ΝΑ ΠΡΟΚΥΨΕΙ ΑΠΟ ΑΞΙΩΣΕΙΣ ΤΡΙΤΟΥ ΜΕΡΟΥΣ ΚΑΤΑ ΤΟΥ ΑΡΧΙΚΟΥ ΑΓΟΡΑΣΤΗ. Η ΟΥΣΙΑ ΤΟΥ ΟΡΟΥ ΑΥΤΟΥ ΕΙΝΑΙ ΝΑ ΠΕΡΙΟΡΙΣΕΙ ΤΗΝ ΠΙΘΑΝΗ ΕΥΘΥΝΗ ΤΗΣ EIZO ΚΑΙ ΤΩΝ ΔΙΑΝΟΜΕΩΝ ΠΟΥ ΠΡΟΚΥΠΤΕΙ ΑΠΟ ΤΗΝ ΠΑΡΟΥΣΑ ΕΓΓΥΗΣΗ Ή/ΚΑΙ ΤΙΣ ΠΩΛΗΣΕΙΣ.

ОГРАНИЧЕННАЯ ГАРАНТИЯ

EIZO Corporation (называемая в дальнейшем “EIZO”) и авторизованные EIZO дистрибуторы (называемые в дальнейшем “Дистрибуторы”) гарантируют, в соответствии с условиями и пунктами этой ограниченной гарантии (называемой в дальнейшем “Гарантия”), первичному покупателю (называемому в дальнейшем “Первоначальный покупатель”), который приобрел у EIZO или Дистрибуторов продукт, указанный в этом документе (называемый в дальнейшем “Продукт”), что EIZO или Дистрибуторы на свое усмотрение либо бесплатно отремонтируют, либо бесплатно заменят Продукт, если Первоначальный покупатель признает в пределах Гарантийного срока (определенного ниже), что Продукт неисправен или он поврежден процессе нормального использования продукта в соответствии с описанием в инструкции по эксплуатации, прилагаемой к Продукту (называемой в дальнейшем “Руководство пользователя”).

Гарантийный период ограничен сроком (i) пять (5) лет от даты приобретения Продукта или ограничен сроком (ii) 30 000 часов использования Продукта (называемый в дальнейшем “Гарантийный период”). EIZO и Дистрибуторы не несут никакой ответственности и не берут обязательств относительно Продукта по отношению к Первоначальному покупателю или по отношению к любым третьим сторонам, кроме обязательств, оговоренных в этой Гарантии.

Компания EIZO и ее дистрибуторы хранят детали изделия (за исключением деталей внешней конструкции) не более 7 (семи) лет после прекращения его выпуска. В случае ремонта монитора EIZO и Дистрибуторы будут использовать запчасти, которые соответствуют нашим стандартам QC (контроль качества). Если устройство невозможно отремонтировать из-за его состояния или отсутствия нужной детали, то вместо ремонта компания EIZO и ее дистрибуторы могут предлагать замену неисправного устройства на устройство с аналогичными характеристиками.

Гарантия действительна только в странах или регионах, где расположены Дистрибуторы. Гарантия не ограничивает никакие законные права Первоначального покупателя.

Несмотря на другие условия этой Гарантии EIZO и Дистрибуторы не несут никаких обязательств согласно этой Гарантии в любом из перечисленных ниже случаев:

- (а) Любые дефекты Продукта, вызванные повреждениями при перевозке, модификацией, изменением, неправильным обращением, неправильным использованием, авариями, неправильной установкой, стихийными бедствиями, неправильным уходом и/или неправильным ремонтом третьей стороной, отличной от EIZO или Дистрибуторов;
- (б) Любые несовместимости Продукта из-за технических усовершенствований и/или изменения технических норм;
- (в) Любое повреждение датчика;
- (г) Любые ухудшения работы дисплея, вызванные изнашиванием невосстановимых частей, таких как панель ЖКД и/или подсветка и т.д. (например, изменение в яркости, изменение в равномерности яркости, изменение в цветности, изменение в равномерности цветности, изменение в пикселах, включая выгоревшие пиксели и т.д.);
- (д) Любые дефекты Продукта, вызванные внешним оборудованием;
- (е) Любые дефекты Продукта, при которых оригинальный серийный номер был изменен или удален;
- (ж) Любые естественные ухудшения продукта, в частности, вызванные износом расходных частей, принадлежностей и/или приспособлений (например, кнопок, вращающихся частей, кабелей, Руководства пользователя и т.д.); и
- (з) Любые деформации, изменения цвета и/или коробления внешней поверхности продукта, включая поверхность панели ЖКД.

Чтобы получить техническое обслуживание в рамках Гарантии, Первоначальный покупатель должен доставить Продукт местному Дистрибутору, оплатив перевозку, в его оригинальной упаковке или в другой соответствующей упаковке, обеспечивающей равноценную степень защиты, принимая во внимание риск повреждения и/или утерю при транспортировке. При запросе технического обслуживания в рамках Гарантии Первоначальный покупатель должен предоставить свидетельство покупки продукта и даты покупки.

Гарантийный период для любого замененного и/или отремонтированного продукта в рамках Гарантии истекает в конце завершения срока действия оригинального Гарантийного периода.

EIZO ИЛИ ДИСТРИБУТОРЫ НЕ НЕСУТ ОТВЕТСТВЕННОСТИ ЗА ЛЮБЫЕ ПОВРЕЖДЕНИЯ ИЛИ УТЕРЮ ДАННЫХ ИЛИ ДРУГОЙ ИНФОРМАЦИИ, ХРАНЯЩИХСЯ НА КАКИХ-ЛИБО НОСИТЕЛЯХ ИНФОРМАЦИИ ИЛИ НА ЛЮБЫХ ДРУГИХ ЧАСТЯХ ПРОДУКТА, КОТОРЫЙ ВОЗВРАЩЕН EIZO ИЛИ ДИСТРИБУТОРАМ ДЛЯ РЕМОНТА.

EIZO И ДИСТРИБУТОРЫ НЕ ДАЮТ НИКАКОЙ ДАЛЬНЕЙШЕЙ ГАРАНТИИ, ВЫРАЖЕННОЙ ИЛИ ПОДРАЗУМЕВАЕМОЙ, ОТНОСИТЕЛЬНО ПРОДУКТА И ЕГО КАЧЕСТВА, ТЕХНИЧЕСКИХ ХАРАКТЕРИСТИК, ТОВАРНОСТИ ИЛИ СООТВЕТСТВИЯ ДЛЯ КАКОГО-ЛИБО ОПРЕДЕЛЕННОГО ИСПОЛЬЗОВАНИЯ. НИ ПРИ КАКИХ УСЛОВИЯХ EIZO ИЛИ ДИСТРИБУТОРЫ НЕ НЕСУТ ОТВЕТСТВЕННОСТИ ЗА ЛЮБОЙ СЛУЧАЙНЫЙ, КОСВЕННЫЙ, СПЕЦИАЛЬНЫЙ, ПОБОЧНЫЙ ИЛИ ИНОЙ УЩЕРБ (ВКЛЮЧАЯ, БЕЗ ОГРАНИЧЕНИЙ, УЩЕРБ ИЗ-ЗА НЕПОЛУЧЕННОЙ ПРИБЫЛИ, ПРЕРЫВАНИЯ БИЗНЕСА, ПОТЕРИ КОММЕРЧЕСКОЙ ИНФОРМАЦИИ ИЛИ ЛЮБЫЕ ДРУГИЕ ФИНАНСОВЫЕ ПОТЕРИ), ВОЗНИКШИЙ ИЗ-ЗА ИСПОЛЬЗОВАНИЯ ИЛИ НЕВОЗМОЖНОСТИ ИСПОЛЬЗОВАТЬ ПРОДУКТ ИЛИ В ЛЮБОЙ ДРУГОЙ СВЯЗИ С ПРОДУКТОМ, ЛИБО ОСНОВАННЫЙ НА КОНТРАКТНЫХ ОТНОШЕНИЯХ, ГРАЖДАНСКИХ ПРАВОНАРУШЕНИЯХ, НЕБРЕЖНОСТИ, ПРИЧИНЕНИЯ УЩЕРБА ТРЕТЬЕЙ СТОРОНЕ ИЛИ ЧЕМ-ЛИБО ЕЩЕ, ДАЖЕ ЕСЛИ EIZO ИЛИ ДИСТРИБУТОРЫ БЫЛИ УВЕДОМЛЕННЫ О ВОЗМОЖНОСТИ ТАКОГО УЩЕРБА. ЭТО ИСКЛЮЧЕНИЕ ТАКЖЕ ВКЛЮЧАЕТ ЛЮБЫЕ ОБЯЗАТЕЛЬСТВА, КОТОРЫЕ МОГУТ ВОЗНИКНУТЬ В РЕЗУЛЬТАТЕ ТРЕБОВАНИЙ ТРЕТЬЕЙ СТОРОНЫ В ОТНОШЕНИИ ПЕРВОНАЧАЛЬНОГО ПОКУПАТЕЛЯ. СУЩЕСТВОМ ЭТОГО ПОЛОЖЕНИЯ ЯВЛЯЕТСЯ ОГРАНИЧЕНИЕ ПОТЕНЦИАЛЬНОЙ ОТВЕТСТВЕННОСТИ EIZO И ДИСТРИБУТОРОВ, ВОЗНИКАЮЩЕЙ ИЗ-ЗА ЭТОЙ ОГРАНИЧЕННОЙ ГАРАНТИИ И/ЛИ ПРОДАЖ.

有限责任保证书

EIZO Corporation (以下简称“EIZO”)和 EIZO 授权的经销商 (以下简称“经销商”), 接受并依照本有限责任保证书 (以下简称“保证书”)之条款, 向从 EIZO 和经销商购买本文中所规定产品 (以下简称“产品”)的原买方 (以下称“原买方”)提供保证:在保证期内 (规定如下), 如果原买方发现按本产品所附使用说明书 (以下简称“用户手册”)所述方式正常使用本产品过程中, 本产品出现故障或损坏, EIZO 和经销商根据其独立的判断免费修理或更换该产品。

本保证期限定为(i)自本产品购买之日起的五(5)年期间或限定为到达(ii)使用本产品 3 万小时的期限(以下简称“保证期限”)。EIZO 和经销商将不向原买方或任何第三方承担本保证书所规定之外的与本产品有关的任何责任或义务。

零件停产七(7)年后, EIZO 及其经销商不再保留或保存产品的任何零件 (设计零件除外)。维修显示器时, EIZO 与经销商将使用符合我方质量控制标准的替换零件。若由于自身条件或缺少相关零件而不能修理设备, EIZO 和经销商可提供性能相同的更换产品, 而无需维修。

本保证书仅对于设有经销商的国家或地区有效。本保证书并不限定原买方的任何法律权利。

无论本保证书的任何其他条款如何规定, 对于任何下列情况之一, EIZO 和经销商将不承担本保证书规定责任:

- (a) 由于运输损害、改装、改动、滥用、误用、意外事故、错误安装、灾害、维护不善和 / 或由除 EIZO 和经销商以外的第三方进行不适当的修理造成本产品的任何故障。
- (b) 由于可能发生的技术变更和 / 或调整造成本产品的任何不兼容性。
- (c) 传感器的任何劣化。
- (d) 由于诸如液晶显示屏 (LCD) 和 / 或背灯等消耗品部件的老化造成的任何显示性能低劣 (如亮度变化、亮度均一性变化、色彩变化、色彩均一性变化、如烧伤像素等像素缺陷)。
- (e) 因外部设备造成本产品的任何故障。
- (f) 因本产品的原序号被改变或消除造成本产品的任何故障。
- (g) 本产品的任何正常老化, 尤其是消耗品、附件和 / 或附加装置 (如按钮、旋转部件、电缆、用户手册等)、以及
- (h) 本产品表面包括液晶显示屏 (LCD) 表面的任何变形、变色和 / 翘曲。

为了获得本保证书规定的服务, 原买方必须使用原包装或其他具有同等保护程度的适当包装将本产品运送到当地的经销商, 并且预付运费, 承担运输中的损坏和 / 或损失的风险。要求提供本保证书规定的服务时, 原买方必须提交购买本产品和标明此购买日期的证明。

按本保证书规定进行了更换和 / 或修理的任何产品的保证期限, 将在原保证期限结束时终止。

在返回给 EIZO 和经销商进行修理后, 任何产品的任何媒体或任何部件中储存的数据或其他信息发生任何损坏或损失, 对此 EIZO 和经销商将不承担责任。

对于本产品及其质量、性能、可销售性以及对于特殊用途的适合性, EIZO 和经销商不提供其他任何明示或暗示的保证。因使用本产品或无法使用本产品或因与本产品有任何关系 (无论是否根据合同) 而造成:任何附带的、间接的、特殊的、随之发生的或其他的损害 (包括但不限于: 利润损失、业务中断、业务信息丢失或其他任何金钱损失) 以及侵权行为、过失、严格赔偿责任或其他责任, 即使已经向 EIZO 和经销商提出了发生这些损害的可能性, 对此 EIZO 和经销商概不承担责任。本免责条款还包括因第三方向原买方提出索赔而可能发生的任何责任。本条款的本质是限定由于本有限责任保证书和 / 或销售本产品所发生的 EIZO 和经销商的潜在责任。

Recycling Information

Recycling Information

This product, when disposed of, is supposed to be collected and recycled according to your country's legislation to reduce environmental burden. When you dispose of this product, please contact a distributor or an affiliate in your country.

The contact addressees are listed on the EIZO website below.

<http://www.eizoglobal.com>

For recycling information for customers in Switzerland, please refer to the following website.

<http://www.swico.ch>

Informationen zum Thema Recycling

Dieses Produkt muss gemäß den Vorschriften Ihres Landes zur Entlastung der Umwelt recyclet werden. Wenden Sie sich bei der Entsorgung dieses Produkts an einen Verteiler oder eine Tochtergesellschaft in Ihrem Land.

Die Adressen zur Kontaktaufnahme sind auf der unten angegebenen Website von EIZO aufgeführt.

<http://www.eizoglobal.com>

Kunden in der Schweiz entnehmen Informationen zum Recycling der folgenden Website:

<http://www.swico.ch>

Informations sur le recyclage

Ce produit doit être jeté aux points de collecte prévus à cet effet et recyclé conformément à la législation de votre pays, afin de réduire l'impact sur l'environnement. Lorsque vous jetez ce produit, veuillez contacter un distributeur ou une société affiliée de votre pays.

Les adresses des distributeurs sont répertoriées sur le site Web EIZO ci-dessous.

<http://www.eizoglobal.com>

Pour les clients en Suisse, veuillez consulter le site Web suivant afin d'obtenir des informations sur le recyclage.

<http://www.swico.ch>

Información sobre reciclaje

Este producto debe desecharse y reciclarse según la legislación del país para reducir el impacto medioambiental. Cuando desee deshacerse de este producto, póngase en contacto con un distribuidor o una filial de su país.

Encontrará las direcciones de contacto en el sitio web de EIZO que se indica a continuación.

<http://www.eizoglobal.com>

Informazioni sul riciclaggio

Per lo smaltimento e il riciclaggio del presente prodotto, attenersi alle normative vigenti nel proprio paese per ridurre l'impatto ambientale. Per lo smaltimento, rivolgersi ad un distributore o un affiliato presenti nel proprio paese.

Gli indirizzi sono elencati nel sito Web EIZO riportato di seguito.

<http://www.eizoglobal.com>

Per informazioni sul riciclaggio per i clienti in Svizzera, consultare il sito Web riportato di seguito.

<http://www.swico.ch>

Återvinningsinformation

När denna produkt kasseras ska den hanteras och återvinnas enligt landets föreskrifter för att reducera miljöpåverkan. När du kasserar produkten ska du kontakta en distributör eller representant i ditt land.

Kontaktadresserna listas på EIZO-webbplatsen nedan.

<http://www.eizoglobal.com>

Πληροφορίες ανακύκλωσης

Το προϊόν αυτό, όταν απορρίπτεται, πρέπει να συλλέγεται και να ανακυκλώνεται σύμφωνα με τη νομοθεσία της χώρας σας έτσι ώστε να μην επιβαρύνει το περιβάλλον. Για να απορρίψετε το προϊόν, επικοινωνήστε με έναν αντιπρόσωπο ή μια θυγατρική εταιρεία στη χώρα σας.

Οι διευθύνσεις επικοινωνίας αναγράφονται στην τοποθεσία web της EIZO παρακάτω.

<http://www.eizoglobal.com>

Сведения по утилизации

По истечении срока службы данного продукта его следует принести на сборный пункт и утилизировать в соответствии с действующими предписаниями в вашей стране, чтобы уменьшить вредное воздействие на окружающую среду. Прежде чем выбросить данный продукт, обратитесь к дистрибьютору или в местное представительство компании в вашей стране.

Контактные адреса можно найти на веб-узле EIZO.

<http://www.eizoglobal.com>

Informatie over recycling

Wanneer u dit product wilt weggooien, moet het uit milieu-overwegingen worden verzameld en gerecycled volgens de betreffende wetgeving van uw land. Wanneer u dit product wilt weggooien, moet u contact opnemen met een distributeur of een partner in uw land.

De contactadressen worden vermeld op de volgende EIZO-website.

<http://www.eizoglobal.com>

Informação sobre reciclagem

Este produto, quando o deitar fora, deve ser recolhido e reciclado de acordo com a legislação do seu país para reduzir a poluição. Quando deitar fora este produto, contacte um distribuidor ou uma filial no seu país.

Os endereços de contacto estão listados no website do EIZO, abaixo.

<http://www.eizoglobal.com>

Oplysninger om genbrug

Denne produkt forventes ved bortskaffelse at blive indsamlet og genbrugt i overensstemmelse med lovgivningen i dit land for at reducere belastningen af miljøet. Når du bortskaffer denne produkt, skal du kontakte en distributør eller et tilknyttet selskab i dit land.

Adresserne på kontaktpersonerne er angivet på EIZO's websted nedenfor.

<http://www.eizoglobal.com>

Kierrätystä koskevia tietoja

Tuote tulee hävittää kierrätämällä maan lainsäädännön mukaisesti ympäristön kuormittumisen vähentämiseksi. Kun hävität tuotteen, ota yhteyttä jälleenmyyjään tai tytäryhtiöön maassasi.

Yhteystiedot löytyvät EIZOn Internet-sivustolta.

<http://www.eizoglobal.com>

Wykorzystanie surowców wtórnych

Ten produkt po zużyciu powinien być zbierany i przetwarzany zgodnie z krajowymi przepisami dotyczącymi ochrony środowiska. Wyrzucając ten produkt, należy skontaktować się z lokalnym dystrybutorem lub partnerem. Adresy kontaktowe można znaleźć we wskazanej poniżej witrynie internetowej firmy EIZO.

<http://www.eizoglobal.com>

Informace o recyklaci

Při likvidaci produktu musí být produkt vyzvednut a recyklován podle zákonů příslušné země, aby nedocházelo k zatěžování životního prostředí. Zbavujete-li se produktu, kontaktujte distributora nebo pobočku ve své zemi. Kontaktní adresy jsou uvedeny na následující webové stránce společnosti EIZO.
<http://www.eizoglobal.com>

Ringlussevõtu alane teave

Keskkonnakoormuse vähendamiseks tuleks kasutatud tooted kokku koguda ja võtta ringlusse vastavalt teie riigi seadustele. Kui kõrvaldate käesoleva toote, võtke palun ühendust turustaja või filiaaliga oma riigis. Kontaktisikud on toodud EIZO veebilehel järgmisel aadressil:
<http://www.eizoglobal.com>

Újrahasznosítási információ

Jelen terméket, amikor eldobjuk, az illető ország törvényei alapján kell összegyűjteni és újrahasznosítani, hogy csökkentsük a környezet terhelését. Amikor ezt a terméket eldobja, kérjük lépjen kapcsolatba egy országon belüli forgalmazóval vagy társvállalkozással.
A kapcsolat címei az EIZO alábbi weboldalán találhatók felsorolva:
<http://www.eizoglobal.com>

Podatki o recikliranju

Ob koncu uporabe odslužen izdelek izročite na zbirno mesto za recikliranje v skladu z okoljevarstveno zakonodajo vaše države. Prosimo, da se pri odstranjevanju izdelka obrnete na lokalnega distributerja ali podružnico.
Kontaktne naslovi so objavljeni na spodaj navedenih spletnih straneh EIZO:
<http://www.eizoglobal.com>

Informácie o recyklácii

Pri likvidácii musí byť tento výrobok recyklovaný v súlade s legislatívou vašej krajiny, aby sa znížilo zaťaženie životného prostredia. Keď sa chcete zbaviť tohto výrobku, kontaktujte prosím distribútora alebo pobočku vo vašej krajine.
Zoznam kontaktných adries je uvedený na nasledovnej webovej stránke firmy EIZO:
<http://www.eizoglobal.com>

Pārstrādes informācija

Utilizējot šo produktu, tā savākšana un pārstrāde veicama atbilstoši jūsu valsts likumdošanas prasībām attiecībā uz slodzes uz vidi samazināšanu. Lai veiktu šī produkta utilizāciju, sazinieties ar izplatītāju vai pārstāvniecību jūsu valstī.
Kontaktadrese ir norādītas zemāk minētajā EIZO tīmekļa vietnē.
<http://www.eizoglobal.com>

Informacja apie gražinamąjį perdirbimą

Šalinant (išmetant) šiuos gaminius juos reikia surinkti ir perdirbti gražinamuoju būdu pagal jūsų šalies teisės aktus, siekiant sumažinti aplinkos teršimą. Kai reikia išmesti šį gaminį, kreipkitės į jūsų šalyje veikiančią gaminių pardavimo atstovybę arba jos filiaalą.
Kontaktiniai adresatai nurodyti EIZO interneto svetainėje.
<http://www.eizoglobal.com>

Информация относно рециклиране

При изхвърлянето на този продукт се предлага събирането и рециклирането му съобразно законите на вашата страна за да се намали замърсяването на околната среда. Когато искате да се освободите от този продукт, моля свържете се с търговския му представител или със съответните органи отговарящи за това във вашата страна.

Данните за връзка с нас са описани на следния Интернет сайт на EIZO:
<http://www.eizoglobal.com>

Informație referitoare la reciclare

Acest produs, când debarasat, trebuie colectat și reciclat conform legislației țării respective ca să reducem sarcina mediului. Când se debarasează de acest produs, vă rugăm să contactați un distribuitor sau un afiliat al țării respective.

Adresele de contact le găsiți pe pagina de web al EIZO:
<http://www.eizoglobal.com>

معلومات عن إعادة التدوير

عند التخلص من هذا المنتج، من الضروري تجميعه وإعادة تدويره وفقاً للقوانين المتبعة في بلدك لتقليل العبء المسلط على البيئة. عندما تتخلص من هذا المنتج، يرجى الاتصال بموزع أو طرف متنسب إليه في بلدك. عناوين الاتصال مدرجة في موقع ايزو EIZO ادناه على شبكة الانترنت.

<http://www.eizoglobal.com>

Geri Dönüşüm Bilgisi

Bu ürünün, atılacağı zaman, ülkenizin çevre kirliliğinin azaltılması konusundaki mevzuatına göre toplanması ve yeniden değerlendirilmesi gerekmektedir. Ürünü atacağınız zaman lütfen ülkenizdeki bir distribütör veya ilgili kuruluşla temasa geçiniz.

İrtibat adresleri aşağıdaki EIZO web sitesinde verilmiştir.
<http://www.eizoglobal.com>

