

User's Manual

FlexScan® EV2750

Color LCD Monitor

Important

Please read PRECAUTIONS, this User's Manual, and the Setup Guide (separate volume) carefully to familiarize yourself with safe and effective usage.

- Please refer to the Setup Guide for basic information ranging from connection of the monitor to a PC to using the monitor.
- The latest User's Manual is available for download from our web site:
www.eizoglobal.com



Location of Caution Statement

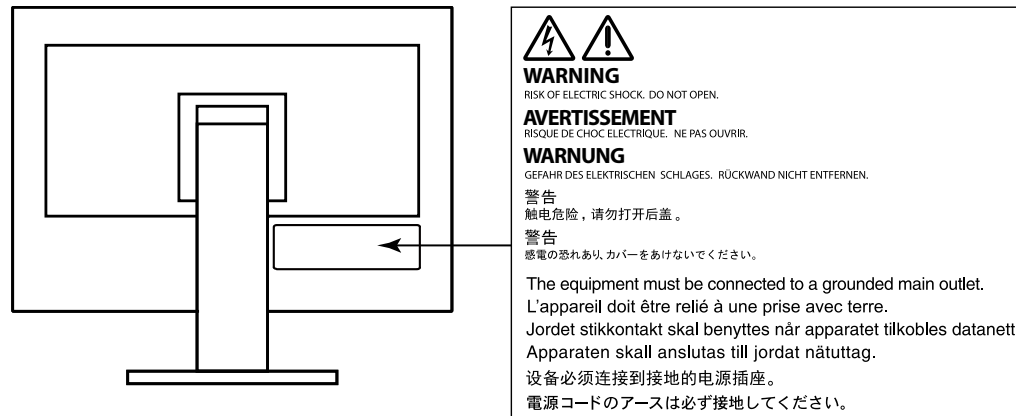

This product has been adjusted specifically for use in the region to which it was originally shipped. If operated outside this region, the product may not perform as stated in the specifications.

No part of this manual may be reproduced, stored in a retrieval system, or transmitted, in any form or by any means, electronic, mechanical, or otherwise, without the prior written permission of EIZO Corporation.

EIZO Corporation is under no obligation to hold any submitted material or information confidential unless prior arrangements are made pursuant to EIZO Corporation's receipt of said information. Although every effort has been made to ensure that this manual provides up-to-date information, please note that EIZO monitor specifications are subject to change without notice.

Notice for this monitor

This product is suited to general purposes like creating documents, viewing multimedia content (Assuming usage of approximately 12 hours per day).

If using this product for the following kinds of applications, where an extremely high degree of reliability and safety is required, then measures should be in place to maintain safety while using this product.

- Transportation equipment (ships, aircraft, trains, and automobiles)
 - Safety devices (Disaster prevention systems, security control systems, etc.)
 - Life-critical devices (medical devices, such as life-support devices and operating room devices)
 - Nuclear energy control devices (Nuclear energy control systems, security control systems of nuclear facilities, etc.)
 - Major system communication devices (operation control systems of transportation systems, air traffic control systems, etc.)
-

This product has been adjusted specifically for use in the region to which it was originally shipped. If the product is used outside the region, it may not operate as specified in the specifications.

This product may not be covered by warranty for uses other than those described in this manual.

The specifications noted in this manual are only applicable when the following are used:

- Power cords provided with the product
 - Signal cables specified by us
-

Only use optional products manufactured or specified by us with this product.

If you place this product on a lacquer-coated desk, the color may adhere to the bottom of the stand due to the composition of the rubber. Check the desk surface before use.

It takes about 30 minutes for the performance of electrical parts to stabilize. Please wait 30 minutes or more after the monitor power has been turned on, and then adjust the monitor.

Monitors should be set to a lower brightness to reduce changes in luminosity caused by long-term use and maintain a stable display.

When the screen image is changed after displaying the same image for extended periods of time, an afterimage may appear. Use the screen saver or power save function to avoid displaying the same image for extended periods of time.

If the monitor displays continuously over a long period of time, dark smudges or burn-in may appear. To maximize the life of the monitor, we recommend the monitor be turned off periodically.

Periodic cleaning is recommended to keep the monitor looking new and to prolong its operation lifetime (refer to “Cleaning” (page 4)).

The LCD panel is manufactured using high-precision technology. Although, missing pixels or lit pixels may appear on the LCD panel, this is not a malfunction. Percentage of effective dots: 99.9994 % or higher.

The backlight of the LCD panel has a fixed lifetime. Depending on the usage pattern, such as usage for long continuous periods, the lifespan of the backlight may run out sooner, requiring replacement. When the screen becomes dark or begins to flicker, please contact your local EIZO representative.

Do not press on the panel or edge of the frame strongly, as this may result in display malfunctions, such as interference patterns, etc. If pressure is continually applied to the panel, it may deteriorate or damage your panel. (If the pressure marks remain on the panel, leave the monitor with a black or white screen. The symptom may disappear.)

Do not scratch or press on the panel with any sharp objects, as this may result in damage to the panel. Do not attempt to brush with tissues as this may scratch the panel.

When the monitor is cold and brought into a room or the room temperature goes up quickly, dew condensation may occur on the interior and exterior surfaces of the monitor. In that case, do not turn the monitor on. Instead wait until the dew condensation disappears, otherwise it may cause some damage to the monitor.

Cleaning

Attention

- Chemicals such as alcohol and antiseptic solution may cause gloss variation, tarnishing, and fading of the cabinet or panel, and also quality deterioration of the image.
- Never use any thinner, benzene, wax, and abrasive cleaner, which may damage the cabinet or panel.

Note

- The optional ScreenCleaner is recommended for cleaning the cabinet and panel surface.

The stains on the cabinet and panel surface can be removed by moistening part of a soft cloth with water.

To use the monitor comfortably

- An excessively dark or bright screen may affect your eyes. Adjust the brightness of the monitor according to the environmental conditions.
- Staring at the monitor for a long time tires your eyes. Take a 10-minute rest every hour.

CONTENTS

Notice for this monitor	3	Chapter 4 Administrator Settings	32
Cleaning	4	4-1. Basic Operation of the “Administrator Settings” Menu	32
To use the monitor comfortably	5	4-2. Functions of the “Administrator Settings” Menu	33
CONTENTS	6	Chapter 5 Troubleshooting	35
Chapter 1 Introduction	7	5-1. No picture	35
1-1. Features	7	5-2. Imaging problems	36
1-2. Controls and Functions	9	5-3. Other problems	38
● Front	9	Chapter 6 Reference	39
● Rear	10	6-1. Attaching the Optional Arm	39
1-3. Supported Resolutions	11	6-2. Detaching/Attaching Stand Base	42
1-4. Setting the Resolution	12	6-3. Attaching/Detaching the Cable Holder	45
● Windows 8.1 / Windows 8 / Windows 7	12	6-4. Making Use of USB (Universal Serial Bus)	47
● Windows Vista	12	● Required System Environment	47
● Mac OS X	12	● Connection Procedure (Setup of USB Function)	47
Chapter 2 Basic Adjustment/Setting	13	6-5. Specifications	48
2-1. Switch Operation Method	13	● Outside Dimensions	50
2-2. Switching Input Signals	14	● Main Default Settings	51
2-3. Switching Display Modes (Color Modes)	15	● Accessories	51
● Display Modes	15	Chapter 7 Glossary	52
2-4. Conserving Energy	16	Appendix	55
2-5. Adjusting Brightness	18	Trademark	55
2-6. Adjusting Volume	19	License / Copyright	55
Chapter 3 Advanced Adjustment/Setting	20	TCO Certified	56
3-1. Basic Operation of the Setting menu	20	FCC Declaration of Conformity	58
3-2. Setting Menu Functions	21	LIMITED WARRANTY	60
● Color Adjustment	21	Recycling Information	69
● Signal Settings	25		
● Preference Settings	28		
● Language	30		
● Information	31		

Chapter 1 Introduction

Thank you very much for choosing an EIZO color LCD monitor.

1-1. Features

- 27.0" wide format LCD
- Native Resolution 2560 × 1440 supported
- IPS panel with 89° horizontal and vertical viewing angles
- Supports three digital signal input interfaces (DisplayPort × 1, DVI-D (Dual Link/Single Link) × 1, HDMI × 1)
 - DisplayPort (8-bit support) ^{*1}

The DisplayPort input receives both image signals and audio signals via a single DisplayPort cable.

^{*1} When transmitting an audio signal using the DisplayPort cable, the graphics board must support audio output.
See ["6-5. Specifications" \(page 48\)](#).
 - HDMI

Supports PC signals via HDMI input.
The HDMI input receives both image signals and audio signals via a single HDMI cable.
- Equipped with "Picture by Picture (PbyP)" function that allows simultaneous display of multiple signals
Eliminates the need for changing between signals and leads to increased work efficiency.
See ["2-2. Switching Input Signals" \(page 14\)](#).
- The Color Mode function allows the user to select the display mode optimum to the displayed image.
The Paper mode reproduces a printed paper effect on the monitor. In Paper mode, the amount of blue light emitted from the screen is reduced by changing the color tone and controlling the brightness.
See ["2-3. Switching Display Modes \(Color Modes\)" \(page 15\)](#).
- Power saving functions
Suppressing power consumption^{*2} reduces carbon dioxide emissions. This product is equipped with power saving functions.
 - 0 W power consumption when the main power is off
Equipped with a main power switch.
When not using the monitor, you can turn off the main power supply so that the power is cut completely.
 - Auto EcoView
The ambient light sensor on the front of the monitor detects the ambient brightness to automatically adjust the screen brightness to a comfortable level. Excessively high brightness may increase power consumption and cause unwanted environmental effects. It may also lead to eye fatigue. The range of automatic adjustment can be configured to personal preference.
See ["Auto EcoView" \(page 17\)](#).

- EcoView Optimizer 2

The monitor automatically adjusts the screen brightness according to the white level of the input signal. This function can reduce power consumption while maintaining the brightness specified by the input signal.

See “EcoView Optimizer 2” (page 17).

- *2 Reference values:

Maximum power consumption: 67 W (when a USB device is connected, speaker working)

Standard power consumption: 22 W (brightness 120 cd/m², DisplayPort input, when no USB device is connected, speaker not working, at default settings)

- Equipped with a USB Hub function that supports USB 3.0

Achieves high-speed data transfers of up to 5 Gbps, which enables transfers of large amounts of data to and from USB-connected devices in a short amount time.

See “6-4. Making Use of USB (Universal Serial Bus)” (page 47).

- High degree of flexibility for installation

- Stand with wide range of movement. The monitor can be adjusted to a position that provides a comfortable and less tiring work environment.

Tilt: 35° up/5° down, swivel: 344°, vertical rotation: left 90° / right 90°, adjustable height: 145 mm (tilt: 35°) / 155 mm (tilt: 0°)

- A thin bezel provides a virtually seamless viewing experience in multiple monitor environments. Mounting the monitor on an arm allows the screen to be installed rotated by 180° (flipped vertically).

Example settings

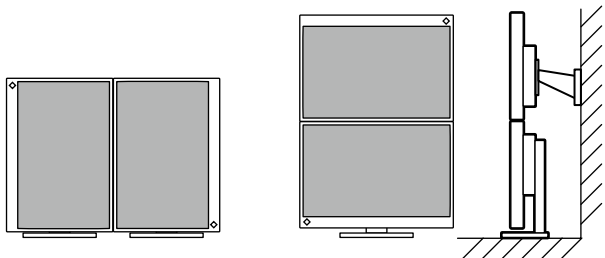

- Change the orientation of the Setting menu when using the monitor screen in the portrait display position (see “Menu Rotation” (page 28)).

- Displays HDCP (High-bandwidth Digital Protection) *3 protected contents.

*3 Supports HDCP Version 1.x

- Supports the “ScreenManager Pro” software for adjusting the screen using the mouse and keyboard

The software can be downloaded from our web site (www.eizo.com).

- Supports the “EIZO Monitor Configurator” software for creating monitor configuration files

When installing multiple units of this monitor, this software allows users to apply a single configuration file to all monitors at the same time. This increases the efficiency of monitor installation work by eliminating the need for configuring each monitor individually.

Please refer to our web site (www.eizo.com) for more details.

1-2. Controls and Functions

● Front

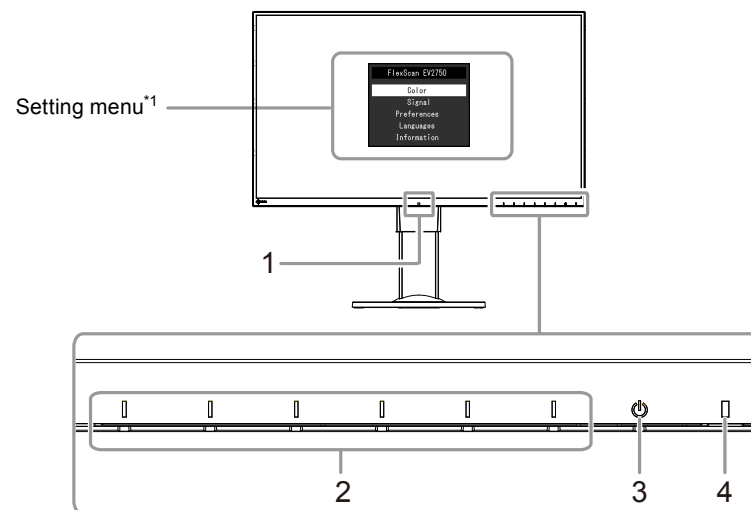

1. Ambient light sensor	Detects ambient brightness (Auto EcoView function (page 17)).
2. Operation switches	Displays menus. Operate the buttons according to the operation guide.
3. Power switch	Turns the power on or off.
4. Power Indicator	Indicates the monitor's operation status. White: Single screen display Orange: Power saving mode OFF: Main power / power off

*1 For details on usage, see "3-1. Basic Operation of the Setting menu" ([page 20](#)).

● Rear

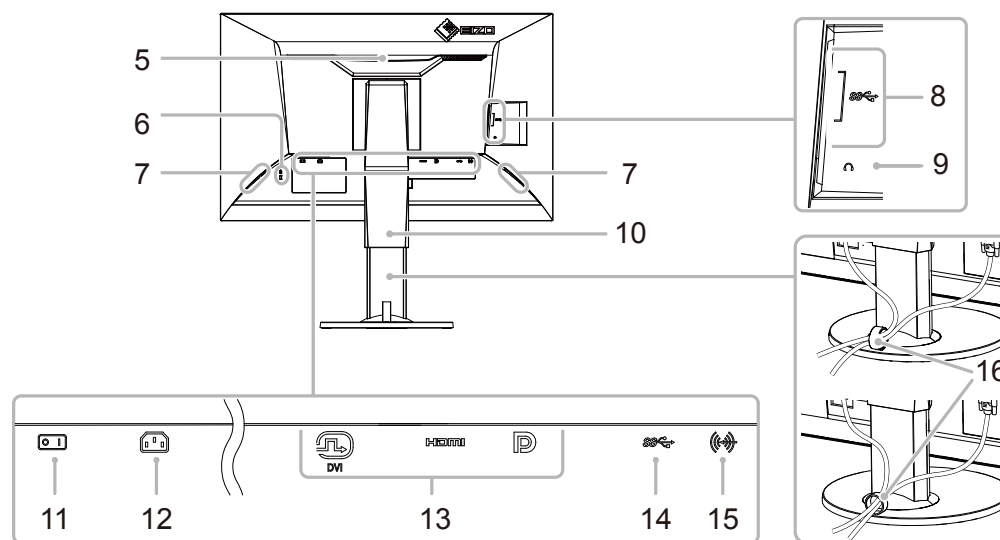

5. Handle	This handle is used for transportation.
6. Security lock slot	Complies with Kensington's MicroSaver security system.
7. Speakers	Outputs audio.
8. USB downstream port	Connects to a peripheral USB device.
9. Headphone jack	Connects to headphones.
10. Stand^{*2}	Adjusts the height and angle (tilt, swivel, and rotation) of the monitor.
11. Main power switch	Turns the main power on or off.
12. Power connector	Connects the power cord.
13. Input signal connectors	Left: DVI connector Middle: HDMI connector Right: DisplayPort connector
14. USB upstream port	Connects to the USB cable when using software that needs a USB connection, or when using the USB Hub function.
15. Stereo Mini Jack	Connects to a stereo mini jack cable.
16. Cable holder^{*3}	Holds the monitor cables.

^{*2} An optional arm (or an optional stand) can be attached by removing the stand section (see “6-1. Attaching the Optional Arm” (page 39)).

^{*3} For the cable holder attachment procedure, see “6-3. Attaching/Detaching the Cable Holder” (page 45).

1-3. Supported Resolutions

The monitor supports the following resolutions.

Resolution	Applicable Signals	Vertical Scan Frequency	DisplayPort		HDMI		DVI	
			Single screen display	PbyP display	Single screen display	PbyP display	Single screen display	PbyP display
640 × 480	VGA/CEA-861	59.94 Hz	√	√	√	√	√	√
640 × 480	CEA-861	60 Hz	√	√	√	√	√	√
720 × 400	VGA TEXT	70.09 Hz	√	√	√	√	√	√
720 × 480 (4:3)	CEA-861	59.94 Hz/60 Hz	√	√	√	√	-	-
720 × 480 (16:9)	CEA-861	59.94 Hz/60 Hz	√	√	√	√	-	-
720 × 576 (4:3)	CEA-861	50 Hz	-	-	√	√	-	-
720 × 576 (16:9)	CEA-861	50 Hz	-	-	√	√	-	-
800 × 600	VESA	60.32 Hz	√	√	√	√	√	√
1024 × 768	VESA	60 Hz	√	√	√	√	√	√
1280 × 720	VESA CVT	59.86 Hz	√	√	√	√	√	√
1280 × 720	VESA CVT RB	59.98 Hz	√	√	√	√	√	√
1280 × 720	CEA-861	50 Hz	-	-	√	√	-	-
1280 × 720	CEA-861	59.94 Hz/60 Hz	√	√	√	√	-	-
1280 × 800	VESA CVT	59.81 Hz	√	√	√	√	√	√
1280 × 1024	VESA	60.02 Hz	√	√	√	√	√	√
1280 × 1440	VESA CVT RB	59.9 Hz	-	√	-	√	-	√
1600 × 900	VESA RB	60 Hz	√	-	√	-	√	-
1600 × 1200	VESA	60 Hz	√	-	√	-	√	-
1680 × 1050	VESA CVT	59.95 Hz	√	-	√	-	√	-
1680 × 1050	VESA CVT RB	59.88 Hz	√	-	√	-	√	-
1920 × 1080	CEA-861	50 Hz	-	-	√	-	-	-
1920 × 1080	CEA-861	59.94 Hz/60 Hz	√	-	√	-	√	-
1920 × 1200	VESA CVT	59.89 Hz	√	-	√	-	√	-
1920 × 1200	VESA CVT RB	59.95 Hz	√	-	√	-	√	-
2560 × 1440	VESA CVT	29.94 Hz	-	-	√	-	√	-
2560 × 1440*	VESA CVT RB	59.95 Hz	√	-	√	-	√	-

* Recommended resolution

Note

- Only the progressive scan type is supported.

1-4. Setting the Resolution

If the resolution is incorrect after connecting the monitor to a PC or if you want to change the resolution, follow the procedure below.

● Windows 8.1 / Windows 8 / Windows 7

1. For Windows 8.1 / Windows 8, click the “Desktop” tile on the Start Screen to display the desktop.
2. Right-click the mouse anywhere on the desktop except for icons.
3. From the displayed menu, click “Screen resolution”.
4. On the “Screen Resolution” dialog box, select the monitor.
5. Click “Resolution” to select the desired resolution.
6. Click the “OK” button.
7. When a confirmation dialog box is displayed, click “Keep changes”.

● Windows Vista

1. Right-click the mouse anywhere on the desktop except for icons.
2. From the displayed menu, click “Personalize”.
3. On the “Personalization” window, click “Display Settings”.
4. On the “Display Settings” dialog box, select the “Monitor” tab and select the desired resolution in the “Resolution” field.
5. Click the “OK” button.
6. When a confirmation dialog box is displayed, click “Yes”.

● Mac OS X

1. Select “System Preferences” from the Apple menu.
2. When the “System Preferences” dialog box is displayed, click “Displays” for “Hardware”.
3. On the displayed dialog box, select the “Display” tab and select the desired resolution in the “Resolutions” field.
4. Your selection will be reflected immediately. If you are satisfied with the selected resolution, close the window.

Chapter 2 Basic Adjustment/Setting

This monitor enables users to change the brightness according to personal preference or to suit the usage environment and reduce power consumption to conserve energy.

This chapter describes the basic functions that can be adjusted and set using the switches on the front of the monitor.

For advanced adjustment and setting procedures using the Setting menu, see “[Chapter 3 Advanced Adjustment/Setting](#)” (page 20).

2-1. Switch Operation Method

1. Displaying the operation guide

1. Touch any switch (except .

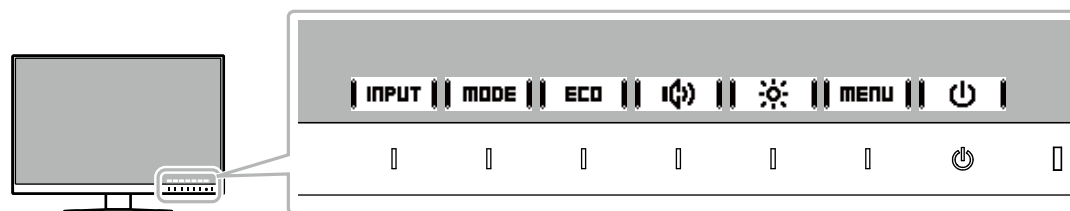

The operation guide appears on the screen.



2. Adjusting/setting

1. Touch a switch for adjustment/setting.

The Adjustment/Setting menu appears.

(A submenu may also be displayed. In this case, select the item for adjustment/setting using  or  and select **ENTER**.)

2. Perform adjustment/setting with the switches and select **OK** to accept the changes.

(To cancel the adjustment/setting and return to the menu, select **CANCEL**.)

3. Exiting

1. Select **OK** or **EXIT** to exit the menu.
2. When no menu is displayed, the operation guide will automatically disappear after a few seconds if no switches are operated.

2-2. Switching Input Signals

When a monitor has multiple signal inputs, the signal to display on-screen can be changed.

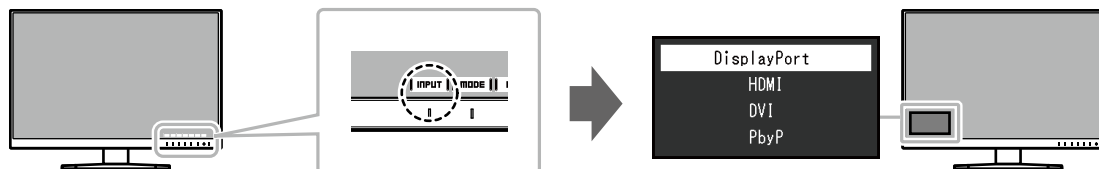

Note

- By selecting PbyP (Picture by Picture) display when a monitor has multiple input signals, windows can be displayed side-by-side. Because 2 windows can be displayed on a single monitor, the need for changing between signals is eliminated, which leads to increased work efficiency. By selecting PbyP display, the combination of the signals to display on the left and right windows can be switched.

PbyP display image

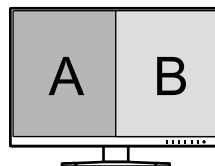

2-3. Switching Display Modes (Color Modes)

This product is preinstalled with color modes for various display purposes.

Switch the mode according to the purpose and content for display. This allows the monitor to display images in a manner appropriate to the display content.

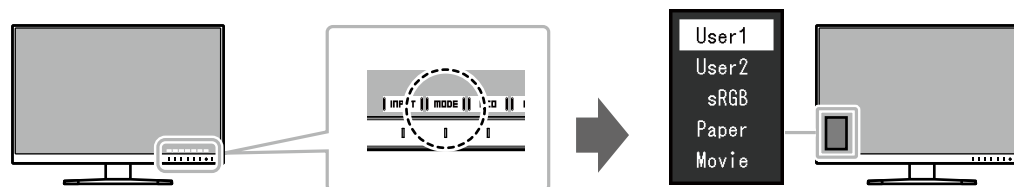

● Display Modes

Color Mode	Purpose
User1 User2	Select either of these modes to set a user-defined display mode.
sRGB	This mode is suitable for matching color reproduction with peripheral devices that support sRGB, such as when printing photos taken using a digital camera.
Paper	This mode uses color tones and contrast similar to that of paper to produce a printed paper effect. It is suitable for displaying images from media such as books and documents.
Movie	This mode displays moving images brightly and with a clear-cut three-dimensional appearance. It is suitable for playing back video content.
DICOM	Allows for display with gradation characteristics compliant with the DICOM Part 14 standard.

Note

- “ScreenManager Pro” allows you to select the color mode automatically according to the application in use. (“ScreenManager Pro” is software for adjusting the screen using the mouse and keyboard. This software can be downloaded from our web site (www.eizoglobal.com).
- The color mode can be set for each input signal that has been set in “2-2. Switching Input Signals” (page 14).
- When using PbyP display, the color mode can be set for the left and right windows individually.

2-4. Conserving Energy

This monitor is equipped with EcoView functions to enable users to conserve energy.

Use this function to curtail unnecessary power consumption and save on electricity expenses. Saving power also reduces CO₂ emissions.

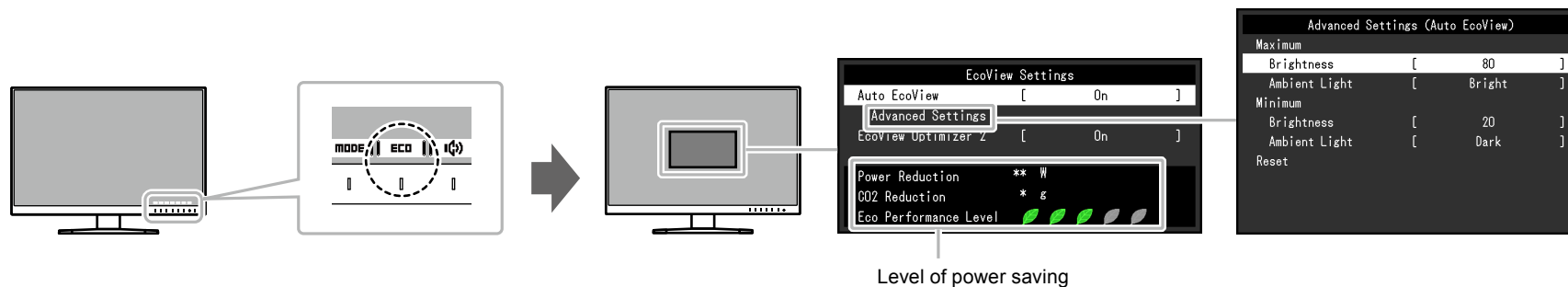

Note

- The power saving level (Power Reduction, CO₂ Reduction, and Eco Performance Level) can be checked on the "EcoView Settings" menu. The more indicators that light up representing the Eco Performance Level, the higher the power saving level attained.
 - Power Reduction: the reduction in the backlight's power consumption as a result of the adjusted brightness value.
 - CO₂ Reduction: converted from the "Power Reduction" value, this is an estimate of the quantity of CO₂ emissions reduced when using the monitor for 1 hour.
- * The numeric value is a result of calculation based on a default setting (0.000555 t -CO₂/kWh) determined by a Japanese ministerial ordinance (2006, Ministry of Economy, Trade and Industry, Ministry of Environment, civil code article 3) and may differ depending on country and year.

Function		Setting Range	Description	Note	
Auto EcoView		On Off	<p>The ambient light sensor on the front of the monitor detects the ambient brightness to automatically adjust the screen brightness to a comfortable level using the Auto EcoView function. The power consumption of the backlight can be curtailed by adjusting the brightness to an appropriate level. This function can also mitigate eye strain and tiredness caused by a screen that is too bright or too dark.</p> <p>Use the “Advanced Settings” to set the automatic adjustment range to suit the monitor’s usage environment or personal preference.</p>	<ul style="list-style-type: none"> • Be careful not to block the ambient light sensor on the lower side of the monitor when using the Auto EcoView function. • Even when the Auto EcoView setting is “On”, the  operation switch on the front of the monitor or color adjustment can be used to change the “Brightness” to suit your personal preference. Moreover, the manner in which the Auto EcoView function changes brightness also differs according to the changed value. • When “DICOM” is selected for the color mode, the Auto EcoView setting is turned “Off”. 	
Advanced Settings	Maximum Minimum	Brightness	0 to 100	<p>Set the range for automatic brightness adjustment. By setting the maximum value and minimum value of the adjustment range in advance, the brightness will be adjusted automatically within the set range.</p>	<ul style="list-style-type: none"> • The maximum and minimum brightness values cannot be set to the same value.
		Ambient Light	Bright Standard Dark	<p>Using the default setting is recommended. (Default setting: “Bright” for maximum value, “Dark” for minimum value)</p>	<ul style="list-style-type: none"> • For details on the “Ambient Light” setting, refer to our web site (www.eizoglobal.com).
	Reset	-	Return the advanced settings to their default values.	-	
EcoView Optimizer 2		On Off	<p>The monitor automatically adjusts the screen brightness according to the white level of the input signal. This function can reduce power consumption while maintaining the brightness specified by the input signal.</p>	<ul style="list-style-type: none"> • The setting is turned “Off” in the following cases: <ul style="list-style-type: none"> - When “sRGB”, “Movie” or “DICOM” is selected for the color mode - During PbyP display • When set to “On”, the appearance of pale colors may change. If this bothers you, set this function to “Off”. 	

2-5. Adjusting Brightness

The brightness of the screen can be adjusted to suit the installation environment or personal preference.

The screen brightness is adjusted by changing the brightness of the backlight (light source from the LCD back panel).

Setting Range

0 to 100

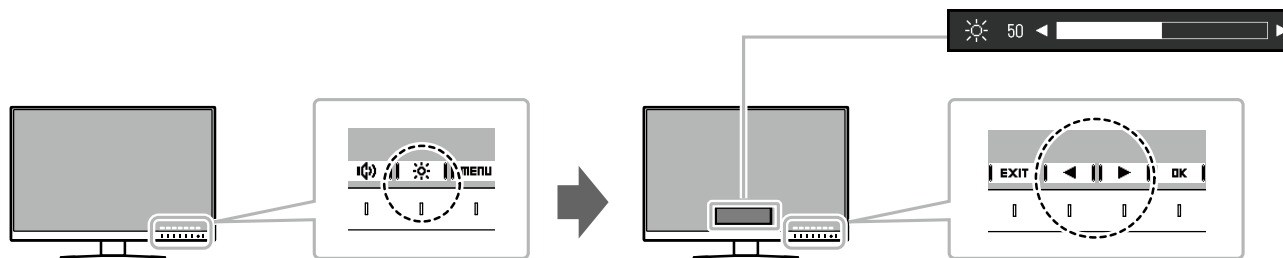

Note

- When “DICOM” is selected for the color mode, the brightness cannot be changed. ☀️ is not displayed on the operation guide or menu.
- When Auto EcoView is set to “On”, the adjustment range is restricted as follows. (For details on Auto EcoView, see “Auto EcoView” (page 17).)
 - The brightness setting cannot be increased or decreased past the maximum and minimum brightness values specified in the advanced settings of Auto EcoView.
 - “Brightness” adjustment may not be possible when the installation environment of the monitor is excessively bright or dark.

2-6. Adjusting Volume

The volume of the speakers and headphones can be set individually.

Setting Range

0 to 30

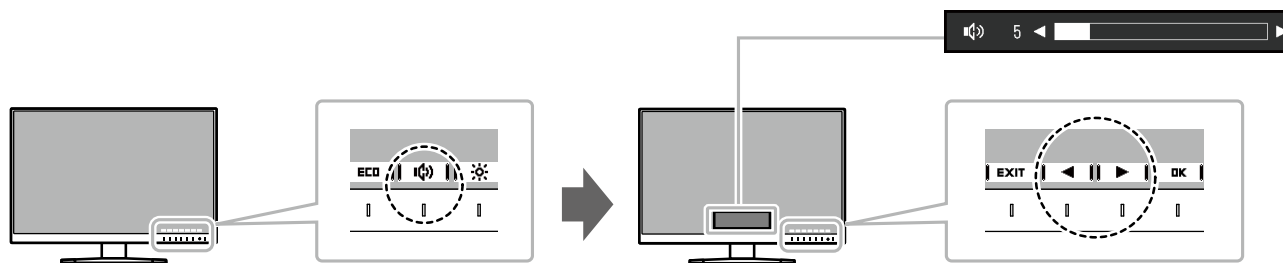

Note

- When "DICOM" is selected for the color mode,  is not displayed on the operation guide or menu.

Chapter 3 Advanced Adjustment/Setting

This chapter describes the advanced monitor adjustment and setting procedures using the Setting menu.

For basic functions, see “Chapter 2 Basic Adjustment/Setting” (page 13).

3-1. Basic Operation of the Setting menu

1. Menu display

1. Touch any switch (except O).
The operation guide appears.
2. Select **| MENU |**.
The Setting menu appears.

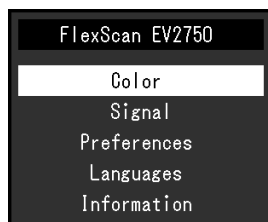

2. Adjusting/setting

1. Select a menu to adjust/set with **| ▲ | | ▼ |** and select **| ENTER |**.
The Sub menu appears.

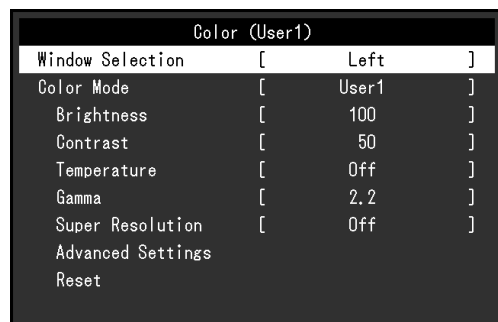

2. Select an item to adjust/set with **| ▲ | | ▼ |** and select **| ENTER |**.
The Adjustment/Setting menu appears.



3. Perform adjustment/setting with **| ▲ | | ▼ |** or **| ◀ | | ▶ |** and select **| OK |** to accept the changes.

The Sub menu appears.

Selecting **| CANCEL |** during adjustment/setting will cancel the adjustment/setting and restore the state prior to making changes.

3. Exiting

1. Select **| RETURN |**.
The Setting menu appears.
2. Select **| EXIT |**.
The Setting menu quits.

3-2. Setting Menu Functions

● Color Adjustment

The color mode setting status can be adjusted according to personal preference.

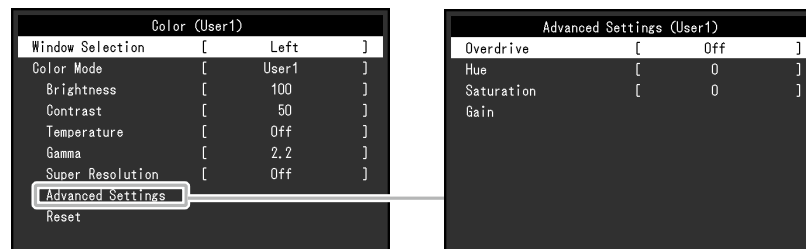

Attention

- It takes about 30 minutes for the performance of electrical parts to stabilize. Please wait 30 minutes or more after power to the monitor has been turned on before adjusting the monitor.
- The same image may be observed in different colors on multiple monitors due to monitor-specific characteristics. Make fine color adjustments visually when matching colors across multiple monitors.

Note

- Using "ScreenManager Pro" allows you to perform color adjustment with the mouse and keyboard on your PC. The adjusted state can also be saved and loaded as color data. "ScreenManager Pro" can be downloaded from our web site (www.eizoglobal.com).

Function	Color Mode (Functions that can be adjusted differ depending on the color mode.) √: Adjustable -: Not adjustable					Setting Range	Description	Note
	User1 User2	sRGB	Paper	Movie	DICOM			
Screen Selection	/					Left Screen Right Screen Whole Screen	Enabled only during PbyP display. Select the application range for each setting of the color adjustment. When using PbyP display, select this range first. <ul style="list-style-type: none"> “Left Screen” The setting is applied only to the left screen. “Right Screen” The setting is applied only to the right screen. “Whole Screen” The setting will be applied to both the left and right screens. 	For details on PbyP, see “2-2. Switching Input Signals” (page 14).
Color Mode	√	√	√	√	√	User1 User2 sRGB Paper Movie DICOM	Select the desired mode according to the monitor application. The color setting status can also be adjusted according to personal preference. Select the mode for adjustment and perform adjustment using the relevant functions.	<ul style="list-style-type: none"> For details on the adjustment status of each mode, see “2-3. Switching Display Modes (Color Modes)” (page 15).
Brightness	√	√	√	√	-	0 to 100	The screen brightness is adjusted by changing the brightness of the backlight (light source from the LCD back panel).	<ul style="list-style-type: none"> If the image is too dark even when the brightness is set to 100, adjust the contrast.

Function	Color Mode (Functions that can be adjusted differ depending on the color mode.) √: Adjustable -: Not adjustable					Setting Range	Description	Note
	User1 User2	sRGB	Paper	Movie	DICOM			
Contrast	√	-	-	√	-	0 to 100	The brightness of the screen is adjusted by varying the video signal level.	<ul style="list-style-type: none"> A contrast of 50 displays every color gradation. When adjusting the monitor, it is recommended to perform brightness adjustment, which does not lose gradation characteristics, prior to contrast adjustment. Perform contrast adjustment in the following cases. <ul style="list-style-type: none"> If the image is too dark even when the brightness is set to 100. (Set the contrast to higher than 50.)
Temperature	√	-	√	√	-	Off 4000 K to 10000 K (specified in 500 K units, includes 9300 K)	<p>Adjust the color temperature.</p> <p>The color temperature is normally used to express the hue of “White” and/or “Black” with a numerical value. The value is expressed in degrees “K” (Kelvin).</p> <p>The screen becomes reddish at low color temperatures and bluish at high color temperatures, similar to the temperatures of a flame. A gain preset value is set for each color temperature setting value.</p>	<ul style="list-style-type: none"> The value shown in “K” is available only as a reference. “Gain” allows you to perform more advanced adjustment. If set to “Off”, the image is displayed in the preset color of the monitor (Gain: 100 for each RGB channel). When the gain is changed, the color temperature setting changes to “Off”.
Gamma	√	-	-	-	-	1.8 2.0 2.2 2.4	<p>Adjust the gamma.</p> <p>While the brightness of the monitor varies depending on the input signal, the variation rate is not proportional to the input signal. Maintaining the balance between the input signal and brightness of the monitor is referred to as “Gamma correction”.</p>	<ul style="list-style-type: none"> If “Paper” is selected for the color mode, “Paper” is displayed for the gamma value. If “DICOM” is selected for the color mode, “DICOM” is displayed for the gamma value.



Function	Color Mode (Functions that can be adjusted differ depending on the color mode.) √: Adjustable -: Not adjustable						Setting Range	Description	Note
	User1 User2	sRGB	Paper	Movie	DICOM				
Smart Resolution	√	-	√	√	-	Standard Low Off	Image blur can be reduced by enhancing its outline.	-	
Advanced Settings	Overdrive	√	-	-	-	-	Enhanced Standard Off	This function allows you to set the overdrive intensity based on the use of the monitor. Image lag can be reduced by using the "Enhanced" setting when displaying moving images.	-
	Hue	√	-	-	√	-	-50 to 50	Adjust the hue.	<ul style="list-style-type: none"> Using this function may make some color gradations unavailable for display.
	Saturation	√	-	-	√	-	-50 to 50	Adjust the color saturation.	<ul style="list-style-type: none"> Using this function may make some color gradations unavailable for display. The minimum value (-50) changes the screen to monochrome.
	Gain	√	-	-	-	-	0 to 100	The brightness of each red, green, and blue color component is referred to as "Gain". The hue of "white" can be changed by adjusting the gain.	<ul style="list-style-type: none"> Using this function may make some color gradations unavailable for display. The gain value changes according to the color temperature. When the gain is changed, the color temperature setting changes to "Off".
Reset	√	√	√	√	-	-	Reset any color adjustments for the currently selected color mode back to the default settings.	-	

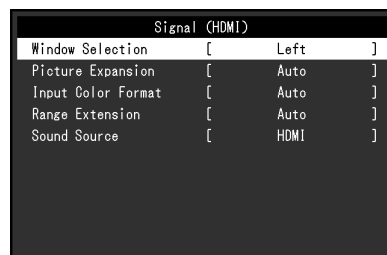

● Signal Settings

Set the method for outputting the signal input from the PC to the monitor.

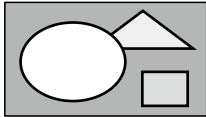
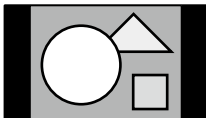

Function	Input Signal (The setting range of each function differs depending on the input signal.) √: Settable -: Not settable				Setting Range	Description	Note
	DisplayPort	HDMI		DVI			
		PC signal	Video signal				
Screen Selection	/				Left Screen Right Screen	<p>Enabled only during PbyP display. Select the application range for the signal settings. When using PbyP display, select this range first.</p> <ul style="list-style-type: none"> “Left Screen” The setting is applied to the left screen. “Right Screen” The setting is applied to the right screen. 	<ul style="list-style-type: none"> For details on PbyP, see “2-2. Switching Input Signals” (page 14).

Function	Input Signal (The setting range of each function differs depending on the input signal.) √: Settable -: Not settable				Setting Range	Description	Note
	DisplayPort	HDMI		DVI			
		PC signal	Video signal				
Picture Expansion	√	√	-	√	Full Screen Aspect Ratio Dot by Dot	<p>The screen size of the monitor display can be changed.</p> <ul style="list-style-type: none"> “Auto” The monitor automatically changes the screen size according to the aspect ratio and resolution information from the PC. “Full Screen” Images are stretched to full screen. Since aspect ratios are not maintained, images may be distorted in some cases. “Aspect Ratio” Images are enlarged to full screen without changing the aspect ratio. Since aspect ratios are maintained, blank horizontal or vertical borders may appear. “Dot by Dot” Displays the image at the set resolution or size specified by the input signal. 	<ul style="list-style-type: none"> • Example settings - Full Screen  - Aspect Ratio  - Dot by Dot (input signal) 
	-	-	√	-	Auto Full Screen Aspect Ratio Dot by Dot		
Input Color Format	√	-	-	-	Auto YUV RGB	<p>The color format of the input signal can be specified. Try changing this setting if colors are not displayed correctly.</p>	<ul style="list-style-type: none"> • This setting is required when a DVI device is connected to the monitor via the HDMI connector port using a DVI-HDMI conversion connector. • This setting is fixed to “RGB” when receiving a DVI signal from the DVI connector.
	-	√	-	-	YUV 4:2:2 YUV 4:4:4 RGB		
	-	-	√	-	Auto YUV 4:2:2 YUV 4:4:4 RGB		

Function	Input Signal (The setting range of each function differs depending on the input signal.) √: Settable -: Not settable				Setting Range	Description	Note
	DisplayPort	HDMI		DVI			
		PC signal	Video signal				
Range Extension	√	-	√	-	Auto On Off	<p>Depending on the PC, black and white of the video level of the signal output to the monitor may be limited. If a limited signal is displayed on the monitor, black will appear faint and white will appear dull, leading to a reduction in contrast. The output range of such signals can be extended to match the actual contrast ratio of the monitor.</p> <ul style="list-style-type: none"> • “Auto” Automatically identifies the brightness range of the input signal and displays the image accordingly. • “On” Extends the signal output range through 0 to 255 and displays the image. • “Off” Extension of the signal output range is not performed. 	<ul style="list-style-type: none"> • Example settings - Off  - On  • This setting is fixed to “Off” for DVI signal input.
	-	√	-	-	On Off		
Sound Source	√	-	-	-	Stereo Mini Jack DisplayPort	<p>The audio source can be changed when receiving DisplayPort signal input or HDMI signal input.</p>	<ul style="list-style-type: none"> • This setting is fixed to “Stereo Mini Jack” when receiving DVI signal input or HDMI (PC signal) input.
	-	-	√	-	Stereo Mini Jack HDMI		

● Preference Settings

The monitor's settings can be configured to suit the usage environment or personal preference.

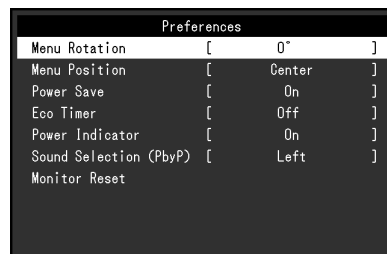

Function	Setting Range	Description	Note
Menu Rotation	0° 90° 270°	Change the orientation of the Setting menu when using the monitor screen in the portrait display position.	<ul style="list-style-type: none"> • Make sure that the cables are correctly connected. • Make sure to turn the monitor screen after pulling the screen up to the uppermost position of the stand and tilting the screen upward. • When using the monitor screen in a portrait position, a graphics board that supports portrait display is required. When placing the monitor in a portrait position, the settings of your graphics board need to be changed. Refer to the User's Manual of the graphics board for details. Please refer to our web site (www.eizoglobal.com) as well. • The menu cannot be rotated by 180°. To install the monitor rotated by 180°, perform monitor adjustment/ settings before rotating the monitor.
Menu Position	Center Upper Right Lower Right Lower Left Upper Left	The display position of the Setting menu can be changed.	-

Function	Setting Range	Description	Note
Power Save	On Off	<p>The monitor can be set to enter power saving mode according to the state of the PC.</p> <p>The monitor changes to power saving mode about 15 seconds after signal input ceases to be detected.</p> <p>When the monitor has shifted to power saving mode, images are not displayed on the screen.</p> <ul style="list-style-type: none"> Exiting power saving mode <ul style="list-style-type: none"> If the monitor receives input, it automatically exits power saving mode and returns to the normal display mode. 	<ul style="list-style-type: none"> At the time of shifting to power saving mode, a message that indicates the transition is displayed 5 seconds in advance. During PbyP display, the monitor only enters power saving mode after both PCs have entered power saving mode or have been switched off. When not using the monitor, you can turn off the main power supply or disconnect the power plug so that the power is cut completely. When the monitor is in power saving mode, devices connected to the USB downstream port will still work. Therefore, power consumption of the monitor varies with connected devices even in power saving mode. Power consumption varies even when the stereo mini jack cable is connected.
Eco Timer	Off 0, 1, 2, 3, 5, 10, 15, 20, 25, 30, 45 min, 1, 2, 3, 4, 5 h	<p>The monitor can be turned off automatically after a specified amount of time has passed in power saving mode.</p> <p>Select the time to wait before turning off power to the monitor.</p>	-
Power Indicator	On Off	The power indicator (white) can be turned off during screen display.	-
Audio Selection (PbyP)	Left Screen Right Screen	<p>Select the source of audio to output from the monitor during PbyP display.</p> <ul style="list-style-type: none"> “Left Screen” Outputs the audio source from the left screen. “Right Screen” Outputs the audio source from the right screen. 	-
Monitor Reset	-	<p>Restore all settings to their default values except for the following settings.</p> <ul style="list-style-type: none"> PbyP Picture Setup Settings on the “Administrator Settings” menu 	<ul style="list-style-type: none"> For details on default settings, see “Main Default Settings” (page 51).

● Language

The display language for menus and messages can be selected.

Setting Range

English, Deutsch, Français, Español, Italiano, Svenska, Japanese, Simplified Chinese, Traditional Chinese



Attention

- The display language of the “Administrator Settings” menu cannot be changed.

● Information

Monitor information (product name, serial number, usage time, resolution, and input signal) can be checked.

(Example)

- Single screen display

```
Information (DisplayPort)
FlexScan ***** S/N: 00000001
Usage Time (h)    0
Input Signal      ****x****
                  fH: **. *kHz
                  fV: **. * Hz
                  fD:***. *MHz
```

- PbyP display



```
Information
FlexScan ***** S/N: 00000001
Usage Time (h)    0
DisplayPort       ****x****
                  fH:***. *kHz
                  fV: **. * Hz
                  fD:***. *MHz
HDMI              ****x****
                  fH:***. *kHz
                  fV: **. * Hz
                  fD:***. *MHz
```

Chapter 4 Administrator Settings

This chapter describes how to configure monitor operation using the “Administrator Settings” menu. This menu is for administrators. Configuration on this menu is not required for normal monitor use.

4-1. Basic Operation of the “Administrator Settings” Menu

1. Menu display

1. Touch  to turn off the monitor.
2. While touching the leftmost switch, touch  for more than 2 seconds to turn on the monitor.

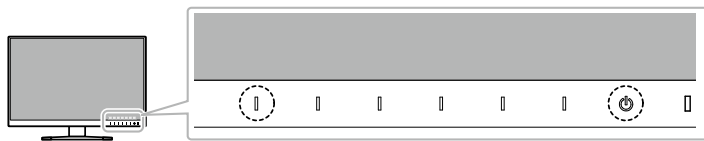

The “Administrator Settings” menu appears.

Administrator Settings		
Auto Input Detection	[On]
Compatibility Mode	[On]
Auto PbyP Resolution	[On]
On-Screen Logo	[On]
Key Lock	[Off]
Apply		

2. Setting

1. Select the item to set with   and select .
- The Adjustment/Setting menu appears.

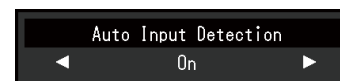

2. Set with   and select .
- The “Administrator Settings” menu appears.

3. Applying and exiting

1. Select “Apply” and select .
- The settings are applied and the “Administrator Settings” menu exits.

Attention

- The language (English) of the “Administrator Settings” menu cannot be changed.

4-2. Functions of the “Administrator Settings” Menu

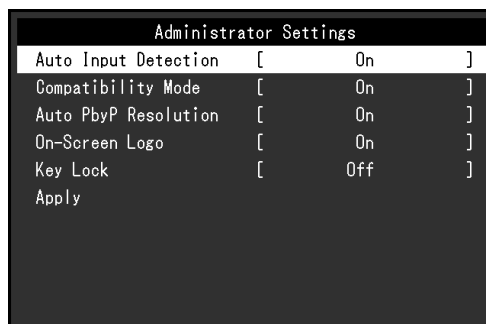

Function	Setting Range	Description	Note
Auto Input Detection	On Off	<p>This monitor recognizes the connector through which PC signals are input and displays images on the screen accordingly. When a PC is turned off or enters power saving mode, any other available signal is displayed automatically.</p> <p>When this function is set to “Off”, the monitor displays the signal from the selected connector regardless of whether a signal is input or not. In this case, select the input signal to display using the INPUT operation switch on the front of the monitor.</p>	<ul style="list-style-type: none"> When set to “On”, the monitor only enters power saving mode after all connected PCs have entered power saving mode or have been switched off. This function is not available during PbyP display.
Compatibility Mode	On Off	<p>When a PC is connected via the DisplayPort connector, window and icon positions may shift when power is turned off/on or after recovering from power saving mode. If this happens, set this function to “On”.</p>	<ul style="list-style-type: none"> This setting can also be changed using the operation switches on the front of the monitor. <ol style="list-style-type: none"> Turn on the monitor. When the operation guide is not displayed, touch the leftmost switch for more than 3 seconds. <p>Each time an operation is executed, the setting changes between On/Off. (When the setting changes, “Compatibility Mode : ON” / “Compatibility Mode : Off” is displayed on the screen.)</p>

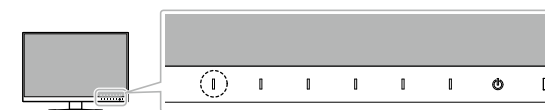



Function	Setting Range	Description	Note
Auto PbyP Resolution	On Off	This product automatically changes the resolution according to the screen layout when changing to PbyP display. Set this function to "Off" to prevent the resolution from changing automatically when changing to PbyP display. In this case, change the resolution manually.	<ul style="list-style-type: none"> If the resolution does not change correctly during PbyP display, it is recommended to change this setting to "Off".
On-Screen Logo	On Off	When the monitor is turned on, the EIZO logo appears on the screen. When this function is set to "Off", the EIZO logo does not appear.	-
Key Lock	On Off	In order to prevent changes to settings, the operation switches on the front of the monitor can be locked.	<ul style="list-style-type: none"> The following operation is available even if the switches are locked: <ul style="list-style-type: none"> - Turning the monitor on or off with the Power switch - Display and operation of the "Administrator Settings" menu







Chapter 5 Troubleshooting

If a problem still remains after applying the suggested remedies, contact your local EIZO representative.

5-1. No picture

Problem	Possible cause and remedy
1. No picture <ul style="list-style-type: none"> Power indicator does not light up. 	<ul style="list-style-type: none"> Check whether the power cord is connected properly. Turn the main power switch on. Touch . Turn off the main power, and then turn it on again a few minutes later.
<ul style="list-style-type: none"> Power indicator is lighting white. 	<ul style="list-style-type: none"> Increase “Brightness”, “Contrast”, or “Gain” in the Setting menu (see “Color Adjustment” (page 21)).
<ul style="list-style-type: none"> Power indicator is lighting orange. 	<ul style="list-style-type: none"> Switch the input signal. Move the mouse or press any key on the keyboard. Check whether the PC is turned on.
<ul style="list-style-type: none"> Power indicator is flashing orange. 	<ul style="list-style-type: none"> The device connected to the DisplayPort has a problem. Resolve the problem, turn off the monitor, and then turn it on again. Refer to the User’s Manual of the output device for further details.
2. The message below appears <ul style="list-style-type: none"> The message shows that the input signal is out of the specified frequency range. Example: 	This message appears when the signal is not input correctly even though the monitor is functioning properly. <ul style="list-style-type: none"> Check whether the PC is configured to meet the resolution and vertical scan frequency requirements of the monitor (see “1-3. Supported Resolutions” (page 11)). Reboot the PC. Select an appropriate setting using the graphics board’s utility. Refer to the User’s Manual of the graphics board for details.

5-2. Imaging problems

Problem	Possible cause and remedy
<p>1. The screen is too bright or too dark.</p>	<ul style="list-style-type: none"> Adjust the “Brightness” or “Contrast” in the Setting menu (see “Color Adjustment” (page 21)). (The LCD monitor backlight has a limited life span. When the screen becomes dark or begins to flicker, contact your local EIZO representative.) If the screen is too bright, try changing the Auto EcoView setting to “On”. The monitor detects the ambient brightness to adjust the screen brightness automatically (see “Auto EcoView” (page 17)).
<p>2. “Brightness” cannot be adjusted</p> <ul style="list-style-type: none"> Cannot increase/decrease setting value (“◀” or “▶” is displayed in gray) <ul style="list-style-type: none"> “Brightness” adjustment menu via  operation switch  “Brightness” adjustment menu in color adjustment  Cannot increase/decrease setting value (“◀” and “▶” are displayed in gray) <ul style="list-style-type: none"> “Brightness” adjustment menu via  operation switch  “Brightness” adjustment menu in color adjustment  	<p>When Auto EcoView is set to “On”, “Brightness” may not be adjustable due to the advanced settings of Auto EcoView.</p> <ul style="list-style-type: none"> The bright adjustment range of the Auto EcoView function can be limited to ensure that the screen is neither too bright nor too dark. When the adjustment range is limited, values outside the range cannot be set. If you want to set a value outside the range, try changing the following settings. <ul style="list-style-type: none"> Change the maximum and minimum values for “Brightness” in the Auto EcoView advanced settings. Set Auto EcoView to “Off”. For details on Auto EcoView settings, see “Auto EcoView” (page 17). Brightness adjustment may not be possible when the installation environment of the monitor is excessively bright or dark. In this case, try changing the following settings. <ul style="list-style-type: none"> Change the maximum and minimum values for “Ambient Light” in the Auto EcoView advanced settings. Set Auto EcoView to “Off”. For details on Auto EcoView settings, see “Auto EcoView” (page 17).
<p>3. Text is blurred</p>	<ul style="list-style-type: none"> Check whether the PC is configured to meet the resolution and vertical scan frequency requirements of the monitor (see “1-3. Supported Resolutions” (page 11)). When an image is displayed with a resolution other than recommended, text or lines in the displayed image may blur. Try adjusting “Smart Resolution” on the Setting menu (see “Smart Resolution” (page 24)).
<p>4. Afterimages appear</p>	<ul style="list-style-type: none"> Afterimages are particular to LCD monitors. Avoid displaying the same image for a long time. Use the screen saver or power saving function to avoid displaying the same image for extended periods of time.

Problem	Possible cause and remedy
5. Green / red / blue / white dots or dark dots remain on the screen.	<ul style="list-style-type: none"> This is due to LCD panel characteristics and not a malfunction.
6. Interference patterns or pressure marks remain on the screen.	<ul style="list-style-type: none"> Leave the monitor with a white or black screen. The symptom may disappear.
7. Noise appears on the screen.	<ul style="list-style-type: none"> In the Setting menu, set "Overdrive" to "Off" (see "Overdrive" (page 24)). When inputting HDCP system signals, normal images may not be displayed immediately.
8. (When using DisplayPort signal input) Position of windows and icons is shifted when turning power off/on or recovering from power saving mode.	<ul style="list-style-type: none"> Set the "Compatibility Mode" setting to "On" using one of the following methods. <ul style="list-style-type: none"> Change the setting using the operation switch on the front of the monitor. <ol style="list-style-type: none"> Turn on the monitor. When the operation guide is not displayed, touch the leftmost switch for more than 3 seconds. Each time an operation is executed, the setting changes between On/Off. (When the setting changes, "Compatibility Mode : On" / "Compatibility Mode : Off" is displayed on screen.) <div data-bbox="1019 606 1803 758" data-label="Image"> </div> Change the setting for "Compatibility Mode" on the "Administrator Settings" menu (see "Compatibility Mode" (page 33)).

5-3. Other problems

Problem	Possible cause and remedy
1. The Setting menu does not appear.	<ul style="list-style-type: none"> • Check whether the switch operation lock function is active (see “Key Lock” (page 34)).
2. No audio output.	<ul style="list-style-type: none"> • Check whether the stereo mini jack cable is connected properly. • Check whether volume is set to 0. • Check the PC and audio playback software to see whether they are configured correctly. • Check the “Source” setting when using DisplayPort input or HDMI input (see “Sound Source” (page 27)). • Check the “Audio Selection (PbyP)” setting during PbyP display (see “Audio Selection (PbyP)” (page 29)).
3. USB devices connected to the monitor do not work.	<ul style="list-style-type: none"> • Check whether the USB cable is connected correctly (see “6-4. Making Use of USB (Universal Serial Bus)” (page 47)). • Try changing to a different USB port. If the PC or peripheral devices work correctly by changing the USB port, contact your local EIZO representative. (Refer to the manual of the PC for details.) • Reboot the PC. • If the peripheral devices work correctly when the PC and peripheral devices are connected directly, contact your local EIZO representative. • Check whether the PC and OS are USB compliant. (For USB compliance of the respective devices, consult their manufacturers.) • Check the PC’s BIOS setting for USB when using Windows. (Refer to the manual of the PC for details.)

Chapter 6 Reference

6-1. Attaching the Optional Arm

An optional arm (or an optional stand) can be attached by removing the stand section. Please refer to our web site for the corresponding optional arm (or optional stand). www.eizoglobal.com

Attention

- When attaching an arm or stand, follow the instructions of the respective User's Manual.
- When using another manufacturer's arm or stand, confirm the following in advance and select one conforming to the VESA standard. Use the optional VESA mount screws when attaching.
 - Clearance between screw holes: 100 mm × 100 mm
 - VESA mount of the arm or stand, external dimensions: 122 mm x 122 mm or less
 - Plate thickness: 2.6 mm
 - Strong enough to support weight of the monitor unit (excluding the stand) and attachments such as cables.
- When using an arm or stand, attach it to meet the following tilt angles of the monitor.
 - Up 45°, down 45° (landscape display, and portrait display rotated 90° clockwise or counterclockwise)
- Connect the cables after attaching an arm or stand.
- Do not move the removed stand up and down. Doing so may result in injury or device damage.
- The monitor, arm, and stand are heavy. Dropping them may result in injury or equipment damage.

Attaching the Optional Arm (Optional Stand)

1. Lay the LCD monitor on a soft cloth spread over on a stable surface with the panel surface facing down.

2. Remove the stand.

As shown below, keep the lock button pressed down (1) and slide the stand towards the stand base until it stops (2). Then, lift the stand up (3).

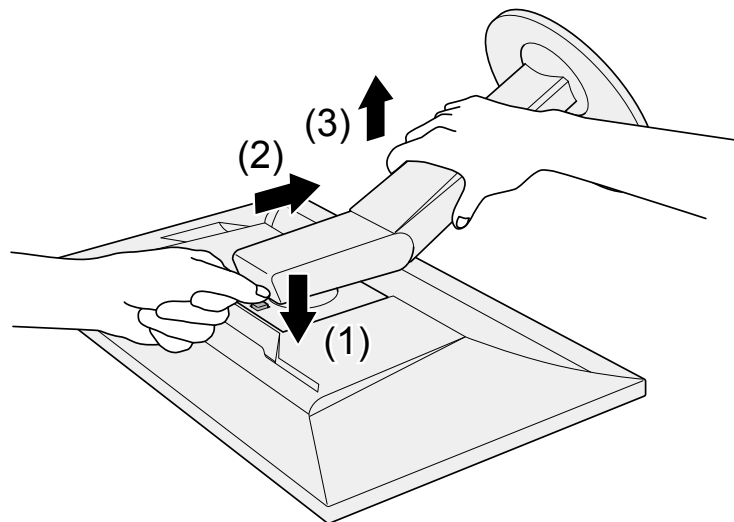

3. Attach the arm or stand to the monitor.

Use the optional VESA mount screws when attaching the arm or stand.

Attaching the original stand

1. Detach the fixing screws on the optional arm (or optional stand) and remove the optional arm (or optional stand).

2. Lay the LCD monitor on a soft cloth spread over on a stable surface with the panel surface facing down.

3. Attach the original stand.

As shown below, insert the four tabs on the stand to the square holes on the back panel (1) and slide the stand towards the upper portion of the monitor until it makes a clicking sound (2).

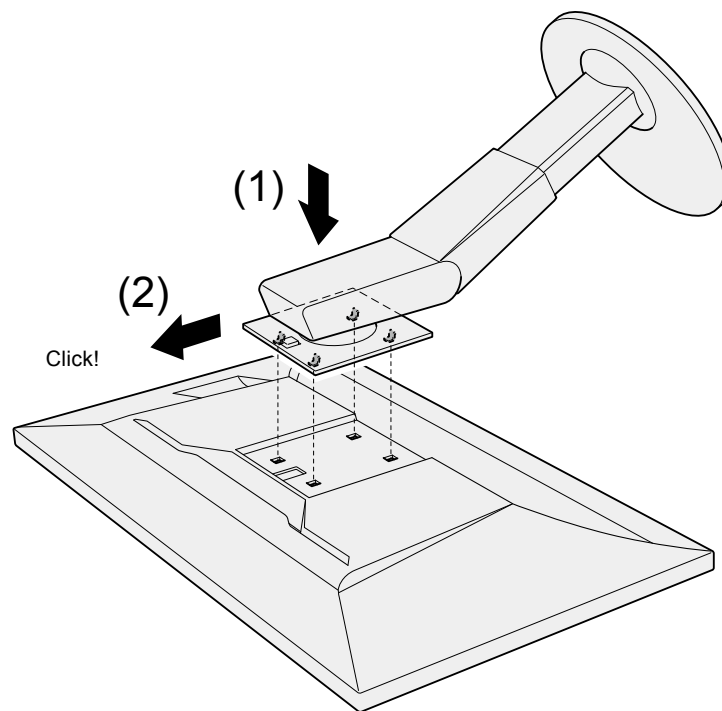

6-2. Detaching/Attaching Stand Base

Detachment procedure

The stand base that was attached during setup can be detached using the following procedures.

1. Lay the LCD monitor on a soft cloth spread over on a stable surface with the panel surface facing down.
2. Raise the lever on the bottom of the stand base.

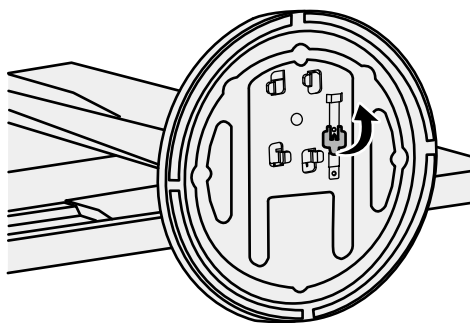

3. Turn the stand base in the counterclockwise direction to detach it.

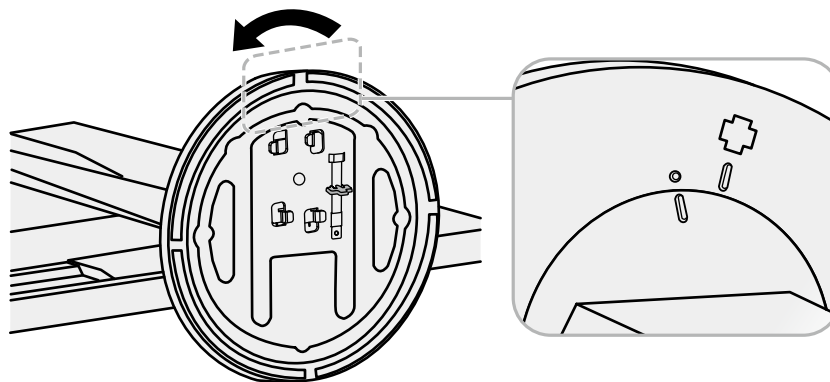

Attachment procedure

The once removed the stand base can be attached to the monitor again with the following procedures.

- 1. Lay the LCD monitor on a soft cloth spread over on a stable surface with the panel surface facing down.**

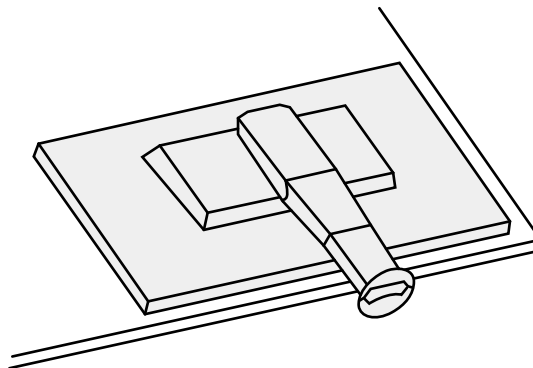

- 2. Attach the stand base onto the stand brace.**

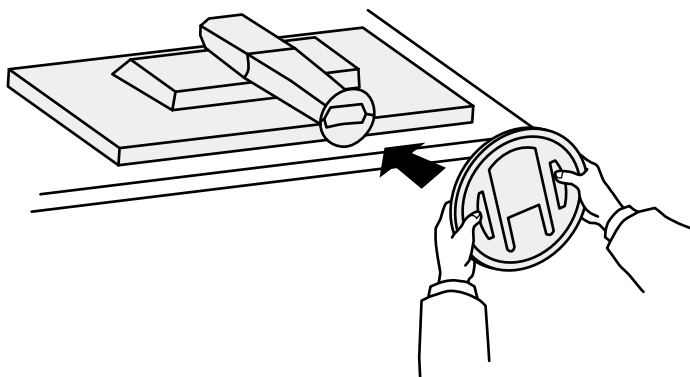

3. Turn the stand base clockwise until it makes a clicking sound.

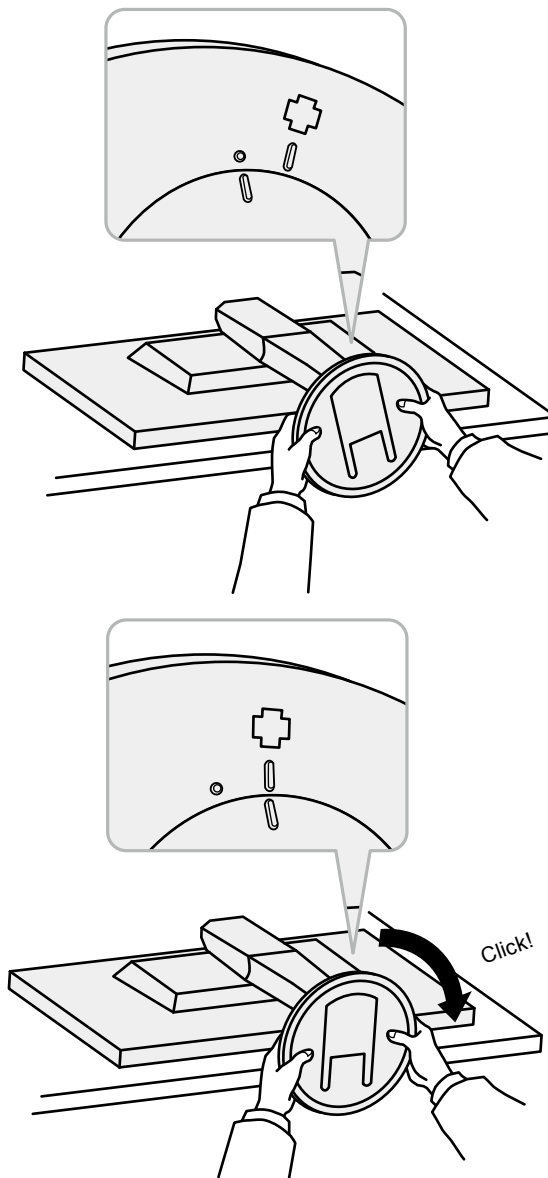

6-3. Attaching/Detaching the Cable Holder

A cable holder is supplied with this product. Use the cable holder to organize the cables connected to the monitor.

Attachment procedure

1. Pass the cables through the cable holder.
2. Close the opening in the cable holder.

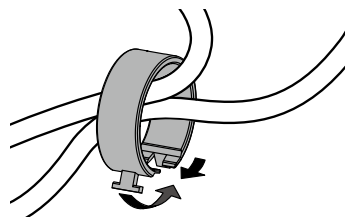

3. While holding the cable holder closed, attach it onto the stand.

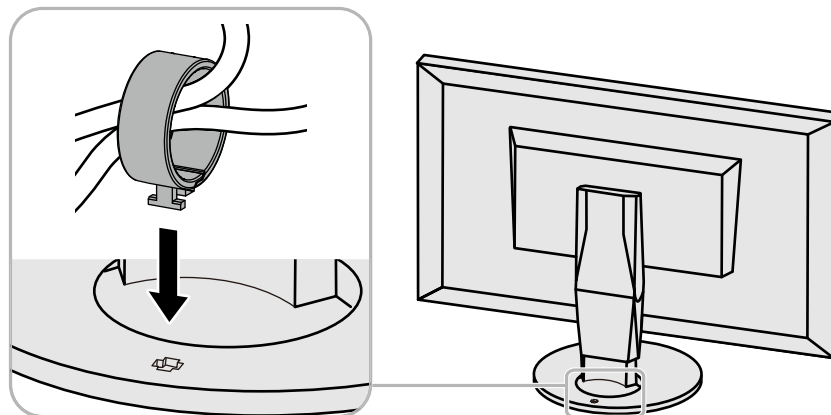

Note

- The cable holder can be inserted either perpendicular or parallel to the stand. Change the direction of the cable holder according to the condition of the cables.

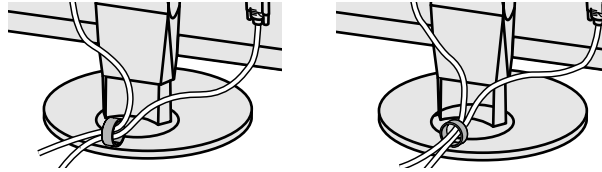
**Detachment procedure**

- 1. Close the opening in the cable holder.**
- 2. While holding the cable holder closed, remove it from the stand.**

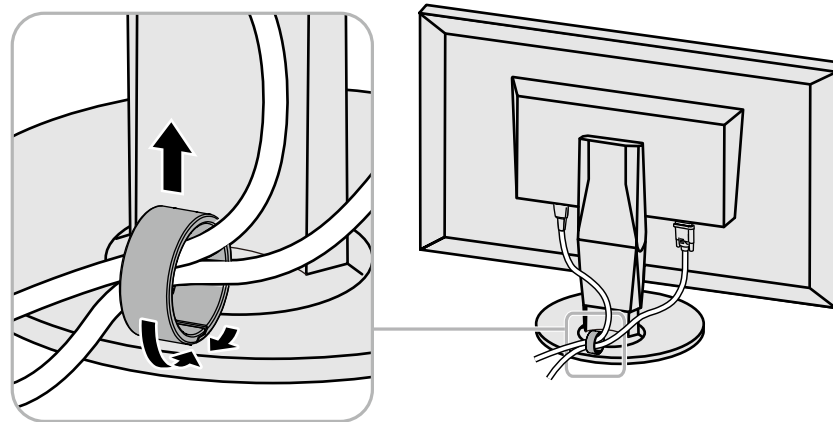

6-4. Making Use of USB (Universal Serial Bus)

This monitor is equipped with a USB hub. It functions as a USB hub when connected to a USB-compatible PC, allowing the connection of peripheral USB devices.

Note

- This product supports USB 3.0. When connecting to peripheral devices that support USB 3.0, high-speed data communication is possible (however, only when the USB cable used to connect the PC and peripheral device is USB 3.0 compliant).

● Required System Environment

- A PC equipped with a USB port
- Windows 8.1 / Windows 8 / Windows 7 / Windows Vista, Mac OS X 10.2 or later, Mac OS 9.2.2
- EIZO USB cable (UU200SS (USB 3.0))

Attention

- This monitor may not work depending on the PC, OS, or peripheral devices to be used. For USB compatibility of peripheral devices, contact their manufacturers.
- When the monitor is in power saving mode, devices connected to the USB downstream port will still work. Therefore, power consumption of the monitor varies with connected devices even in power saving mode.
- When the main power of the monitor is off, a device connected to the USB downstream port will not operate.

● Connection Procedure (Setup of USB Function)

1. Connect the monitor first to a PC using the signal cable, and start the PC.
2. Connect the USB cable between the USB downstream port of the PC and the USB upstream port of the monitor.
The USB hub function is set up automatically upon connection of the USB cable.
3. Connect a peripheral USB device to the USB downstream port of the monitor.

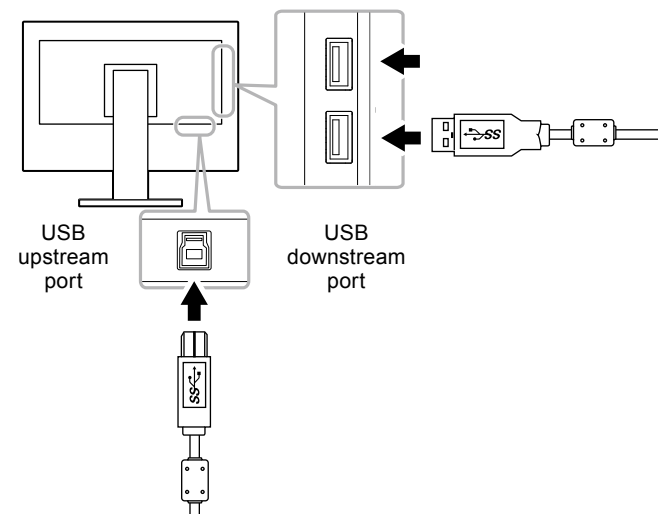

6-5. Specifications

LCD Panel	Type	IPS (Anti-Glare)
	Backlight	LED
	Size	68.5 cm (27.0 inch)
	Native Resolution	2560 dots × 1440 lines
	Display Size (H × V)	596.7 mm × 335.7 mm
	Pixel Pitch	0.233 mm
	Display Colors	8-bit colors: 16.77 million colors
	Viewing Angle (H × V, typical)	178° / 178°
	Response Time (typical)	Gray-to-gray: 15 ms (overdrive setting: Off) 5 ms (overdrive setting: Enhanced)
Video Signals	Input Terminals	DisplayPort (HDCP) × 1, HDMI (HDCP) ^{*1} × 1, DVI-D (HDCP, Dual Link / Single Link) × 1
	Digital Scanning Frequency (H / V)	31 kHz to 89 kHz / 29 Hz to 31 Hz ^{*2} , 59 Hz to 61 Hz (49 Hz to 61 Hz for HDMI) (VGA TEXT: 69 Hz to 71 Hz)
	Max. Dot Clock	241.50 MHz
USB	Port	Upstream port × 1, downstream port × 2
	Standard	USB Specification Revision 3.0
	Communication Speed	5 Gbps (super), 480 Mbps (high), 12 Mbps (full), 1.5 Mbps (low)
	Supply Current	Downstream: Max. 900 mA per port
Audio	Audio Input Format	DisplayPort: 2 ch linear PCM (32 kHz / 44.1 kHz / 48 kHz / 88.2 kHz / 96 kHz)
		HDMI: 2 ch linear PCM (32 kHz / 44.1 kHz / 48 kHz)
	Speakers	1 W + 1 W
	Headphones	2 mW + 2 mW (32 Ω)
	Input Terminals	Line: Stereo mini jack × 1
		DisplayPort × 1, HDMI × 1 (shared with video signal)
Output Terminals	Headphones: Stereo mini jack × 1	

*1 HDMI CEC (or mutual control) is not supported.

*2 For details on applicable signals, see “1-3. Supported Resolutions” (page 11).

Power	Input	100 - 240 VAC \pm 10 %, 50 / 60 Hz 0.70 A - 0.35 A
	Maximum Power Consumption	67 W or less
	Power Save Mode	0.5 W or less (DisplayPort input, no USB device connected, default settings)
	Standby Mode	0.5 W or less (no USB device connected, default settings)
Physical Specifications	Dimensions	611.6 mm \times 399 mm to 544 mm \times 259 mm (W \times H \times D) (Tilt: 35°) 611.6 mm \times 390.2 mm to 545.2 mm \times 245 mm (W \times H \times D) (Tilt: 0°)
	Dimensions (Without Stand)	611.6 mm \times 359 mm \times 48.5 mm (W \times H \times D)
	Net Weight	Approx. 7.9 kg
	Net Weight (Without Stand)	Approx. 5.1 kg
	Height Adjustment Range	145 mm (Tilt: 35°) / 155 mm (Tilt: 0°)
	Tilt	Up 35°, down 5°
	Swivel	344°
Operating Environmental Specifications	Vertical Rotation	Left 90°, right 90°
	Temperature	5 °C to 35 °C (41 °F to 95 °F)
	Humidity	20 % to 80 % R.H. (no condensation)
Transportation/ Storage Environmental Specifications	Air Pressure	540 hPa to 1060 hPa
	Temperature	-20 °C to 60 °C (-4 °F to 140 °F)
	Humidity	10 % to 90 % R.H. (no condensation)
Transportation/ Storage Environmental Specifications	Air Pressure	200 hPa to 1060 hPa

● Outside Dimensions

Unit: mm

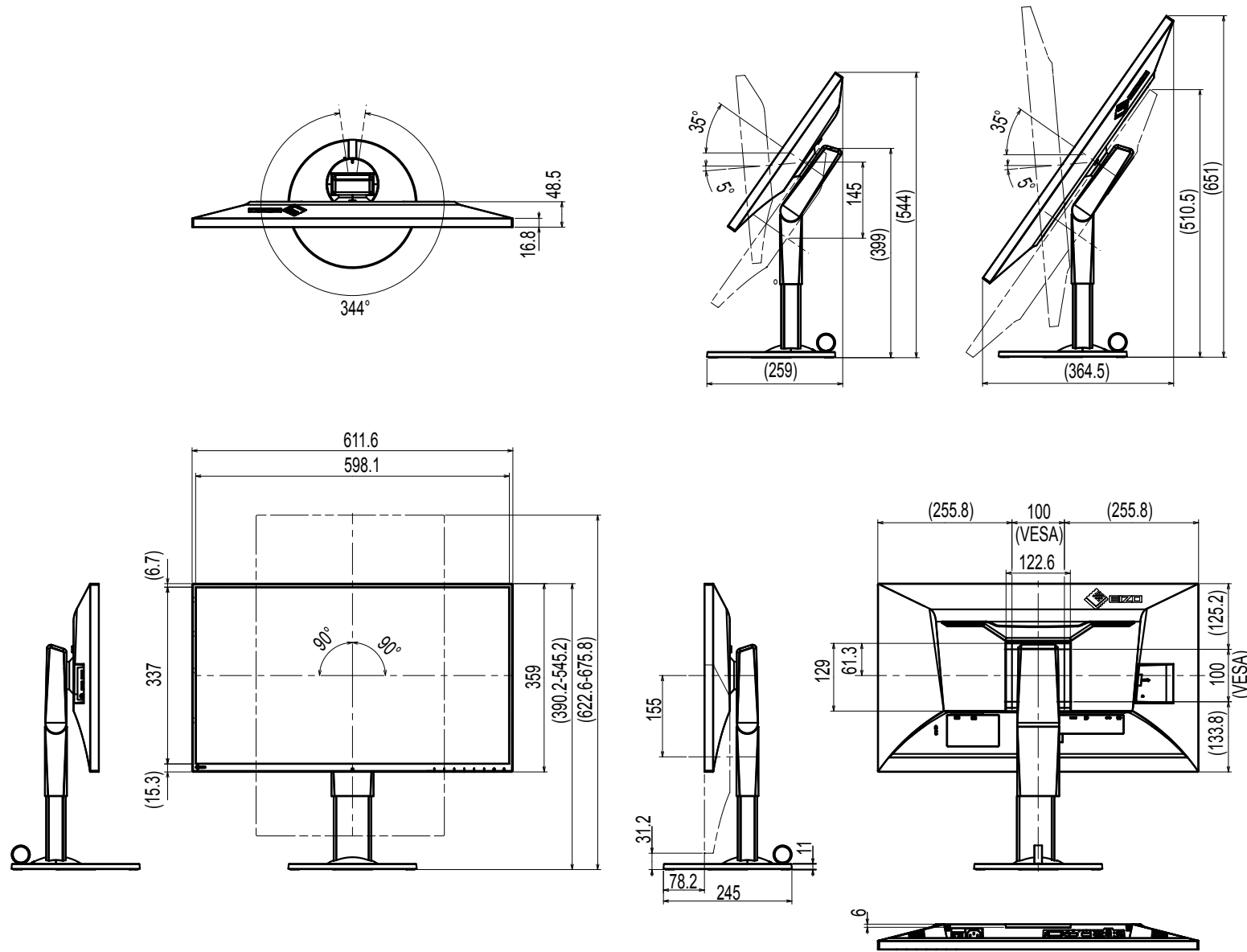

● Main Default Settings

Picture Setup		Single
Auto EcoView		On
EcoView Optimizer 2		On
Color Mode		User1
Picture Expansion	DisplayPort input	Aspect Ratio
	HDMI (PC signal) input	Aspect Ratio
	HDMI (video signal) input	Auto
	DVI-D input	Aspect Ratio
Input Color Format	DisplayPort input	Auto
	HDMI (PC signal) input	RGB
	HDMI (video signal) input	Auto
Menu Rotation		0°
Menu Position		Center
Power Save		On
Eco Timer		Off
Language		English
Power Indicator		On
Audio Selection (PbyP)		Left Screen
Auto Input Detection		On
Compatibility Mode		Off
Auto PbyP Resolution		On
On-Screen Logo		On
Key Lock		Off

● Accessories

Signal cable	<ul style="list-style-type: none"> • DD200DL (DVI-DVI) • HH200HS (HDMI-HDMI)
Cleaning Kit	EIZO "ScreenCleaner"

For the latest information about accessories, refer to our web site.

www.eizoglobal.com

Chapter 7 Glossary

DICOM (Digital Imaging and Communication in Medicine)

The DICOM standard was developed by the American College of Radiology and the National Electrical Manufacturer's Association of the USA. The DICOM compatible device connection enables to transfer the medical image and information. The DICOM, Part 14 document defines the digital, grayscale medical image display.

DisplayPort

This is the interface standard for image signals standardized in accordance with VESA. It was developed with the aim of replacing the conventional DVI and analog interfaces, and it can transmit high resolution signals and sound signals, which DVI does not support. The standard size and mini size connectors have been standardized.

DVI DMPM (DVI Digital Monitor Power Management)

DVI DMPM is a digital interface power saving function. The "Monitor ON (operating mode)" and "Active Off (power saving mode)" are indispensable for DVI DMPM as the monitor's power mode.

Gain

This is used to adjust each color parameter for red, green and blue. An LCD monitor displays the color by the light passing through the panel color filter. Red, green and blue are the three primary colors. All the colors on the screen are displayed by combining these three colors. The color tone can be changed by adjusting the light intensity (volume) passing through each color's filter.

Gamma

Generally, the monitor brightness varies nonlinearly with the input signal level, which is called "Gamma Characteristic". When the gamma value is low, the middle tone area is displayed brighter, and darker when high. Changes to the gamma value will not affect contrast. A gamma value appropriate for the display content should be selected.

HDCP (High-bandwidth Digital Content Protection)

Digital signal coding system developed to copy-protect the digital contents, such as video, music, etc.

This helps to transmit the digital contents safely by coding the digital contents sent via the DVI or HDMI connector on the output side and decoding them on the input side.

Any digital contents cannot be reproduced if both of the equipments on the output and input sides are not applicable to HDCP system.

HDMI (High-Definition Multimedia Interface)

HDMI is a digital interface standard, developed for consumer electrical appliance or AV device. This standard is issued on the basis of the DVI standard which is one of an interface specification for the connection between a PC and a monitor. The projected image, sound and control signal without compressed enable to be transmitted with one cable.

Overdrive

This technology enhances response speed by increasing the potential difference at the time of motion of liquid-crystal pixels, and it is used for liquid-crystal TV sets and others in general. It provides clear-cut three-dimensional display with little afterimage, by improving response speed of the intermediate graduation range that frequently appears in moving images.

Resolution

The LCD panel consists of numerous pixels of specified size, which are illuminated to form images. This monitor consists of horizontal 2560 pixels and 1440 vertical pixels. At a resolution of 2560 × 1440, all pixels are illuminated as a full screen (1:1).

sRGB (Standard RGB)

International standard for color reproduction and color space among peripheral devices (such as monitors, printers, digital cameras, scanners). As a form of simple color matching for the Internet, colors can be displayed using tones close to those of the transmission and reception devices.

Temperature

Color temperature is a method to measure the white color tone, generally indicated in degrees Kelvin. The screen becomes reddish at a low temperature, and bluish at a high temperature, like the flame temperature.

5000 K: Slightly reddish white

6500 K: White referred to as daylight-balanced color

9300 K: Slightly bluish white

TMDS (Transition Minimized Differential Signaling)

A signal transmission system for digital interface.

Appendix

Trademark

The terms HDMI and HDMI High-Definition Multimedia Interface, and the HDMI Logo are trademarks or registered trademarks of HDMI Licensing, LLC in the United States and other countries.

The DisplayPort Compliance Logo and VESA are registered trademarks of the Video Electronics Standards Association.

The SuperSpeed USB Trident Logo is a registered trademark of USB Implementers Forum, Inc.



The USB Power Delivery Trident Logos are trademarks of USB Implementers Forum, Inc.



DICOM is the registered trademark of the National Electrical Manufacturers Association for its standards publications relating to digital communications of medical information.

Kensington and Microsaver are registered trademarks of ACCO Brands Corporation.

Thunderbolt is a trademark of Intel Corporation in the United States and/or other countries.

Microsoft and Windows are registered trademarks of Microsoft Corporation in the United States and other countries.

Adobe is a registered trademark of Adobe Systems Incorporated in the United States and other countries.

Apple, macOS, Mac OS, OS X, Macintosh and ColorSync are registered trademarks of Apple Inc.

EIZO, the EIZO Logo, ColorEdge, CuratOR, DuraVision, FlexScan, FORIS, RadiCS, RadiForce, RadiNET, Raptor and ScreenManager are registered trademarks of EIZO Corporation in Japan and other countries.

ColorEdge Tablet Controller, ColorNavigator, EcoView NET, EIZO EasyPIX, EIZO Monitor Configurator, EIZO ScreenSlicer, G-Ignition, i•Sound, Quick Color Match, RadiLight, Re/Vue, SafeGuard, Screen Administrator, Screen InStyle, ScreenCleaner and UniColor Pro are trademarks of EIZO Corporation.

All other company names, product names, and logos are trademarks or registered trademarks of their respective companies.

License / Copyright

A round gothic bold bit map font designed by Ricoh is used for the characters displayed on this product.

TCO Certified

This product carries the TCO Certified designation (EcoView Optimizer 2: Off, Temperature: Off). TCO Certified is the leading independent sustainability certification for IT products.

For details, see the following pages.

A third-party certification according to ISO 14024



Toward sustainable IT products

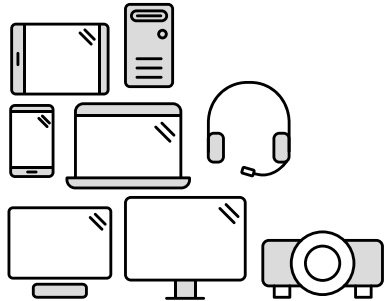

Say hello to a more sustainable product

IT products are associated with a wide range of sustainability risks throughout their life cycle. Human rights violations are common in the factories. Harmful substances are used both in products and their manufacture. Products can often have a short lifespan because of poor ergonomics, low quality and when they are not able to be repaired or upgraded.

This product is a better choice. It meets all the criteria in TCO Certified, the world's most comprehensive sustainability certification for IT products. Thank you for making a responsible product choice, that help drive progress towards a more sustainable future!

Criteria in TCO Certified have a life-cycle perspective and balance environmental and social responsibility. Conformity is verified by independent and approved verifiers that specialize in IT products, social responsibility or other sustainability issues. Verification is done both before and after the certificate is issued, covering the entire validity period. The process also includes ensuring that corrective actions are implemented in all cases of factory non-conformities. And last but not least, to make sure that the certification and independent verification is accurate, both TCO Certified and the verifiers are reviewed regularly.

Want to know more?

Read information about TCO Certified, full criteria documents, news and updates at tco-certified.com. On the website you'll also find our Product Finder, which presents a complete, searchable listing of certified products.

FCC Declaration of Conformity

For U.S.A. , Canada, etc. (rated 100-120 Vac) Only

FCC Declaration of Conformity

We, the Responsible Party

EIZO Inc.

5710 Warland Drive, Cypress, CA 90630

Phone: (562) 431-5011

declare that the product

Trade name: EIZO

Model: FlexScan EV2750

is in conformity with Part 15 of the FCC Rules. Operation of this product is subject to the following two conditions: (1) this device may not cause harmful interference, and (2) this device must accept any interference received, including interference that may cause undesired operation.

This equipment has been tested and found to comply with the limits for a Class B digital device, pursuant to Part 15 of the FCC Rules. These limits are designed to provide reasonable protection against harmful interference in a residential installation. This equipment generates, uses, and can radiate radio frequency energy and, if not installed and used in accordance with the instructions, may cause harmful interference to radio communications. However, there is no guarantee that interference will not occur in a particular installation. If this equipment does cause harmful interference to radio or television reception, which can be determined by turning the equipment off and on, the user is encouraged to try to correct the interference by one or more of the following measures.

- * Reorient or relocate the receiving antenna.
- * Increase the separation between the equipment and receiver.
- * Connect the equipment into an outlet on a circuit different from that to which the receiver is connected.
- * Consult the dealer or an experienced radio/TV technician for help.

Changes or modifications not expressly approved by the party responsible for compliance could void the user's authority to operate the equipment.

Note

Use the attached specified cable below or EIZO signal cable with this monitor so as to keep interference within the limits of a Class B digital device.

- AC Cord
- Shielded Signal Cable (enclosed)

Canadian Notice

This Class B digital apparatus complies with Canadian ICES-003.

Cet appareil numérique de la classe B est conforme à la norme NMB-003 du Canada.

LIMITED WARRANTY

LIMITED WARRANTY

EIZO Corporation (hereinafter referred to as “**EIZO**”) and distributors authorized by EIZO (hereinafter referred to as the “**Distributors**”) warrant, subject to and in accordance with the terms of this limited warranty (hereinafter referred to as the “**Warranty**”), to the original purchaser (hereinafter referred to as the “**Original Purchaser**”) who purchased the product specified in this document (hereinafter referred to as the “**Product**”) from EIZO or Distributors, that EIZO and Distributors shall, at their sole discretion, either repair or replace the Product at no charge if the Original Purchaser becomes aware within the Warranty Period (defined below) that the Product malfunctions or is damaged in the course of normal use of the Product in accordance with the description in the instruction manual attached to the Product (hereinafter referred to as the “**User’s Manual**”).

The period of this Warranty is limited to (i) five (5) years from the date of purchase of the Product; or, limited to the expiration of (ii) 30,000 hours of its use of the Product (hereinafter referred to as the “**Warranty Period**”). EIZO and Distributors shall bear no liability or obligation with regard to the Product in relation to the Original Purchaser or any third parties other than as provided under this Warranty.

EIZO and Distributors will cease to hold or store any parts of the Product upon expiration of seven (7) years after the production of such parts is discontinued. In repairing the monitor, EIZO and Distributors will use renewal parts which comply with our QC standards.

The Warranty is valid only in the countries or territories where the Distributors are located. The Warranty does not restrict any legal rights of the Original Purchaser.

Notwithstanding any other provision of this Warranty, EIZO and Distributors shall have no obligation under this Warranty whatsoever in any of the cases as set forth below:

- (a) Any defect of the Product caused by freight damage, modification, alteration, abuse, misuse, accident, incorrect installation, disaster, faulty maintenance and/or improper repair by third party other than EIZO and Distributors;
- (b) Any incompatibility of the Product due to possible technical innovations and/or regulations;
- (c) Any deterioration of the sensor;
- (d) Any deterioration of display performance caused by the deterioration of expendable parts such as the LCD panel and/or backlight, etc. (e.g. changes in brightness, changes in brightness uniformity, changes in color, changes in color uniformity, defects in pixels including burnt pixels, etc.);
- (e) Any defect of the Product caused by external equipment;
- (f) Any defect of the Product on which the original serial number has been altered or removed;
- (g) Any normal deterioration of the product, particularly that of consumables, accessories, and/or attachments (e.g. buttons, rotating parts, cables, User’s Manual, etc.); and
- (h) Any deformation, discoloration, and/or warp of the exterior of the product including that of the surface of the LCD panel.

To obtain service under the Warranty, the Original Purchaser must deliver the Product, freight prepaid, in its original package or other adequate package affording an equal degree of protection, assuming the risk of damage and/or loss in transit, to the local Distributor. The Original Purchaser must present proof of purchase of the Product and the date of such purchase when requesting services under the Warranty.

The Warranty Period for any replaced and/or repaired product under this Warranty shall expire at the end of the original Warranty Period.

EIZO OR DISTRIBUTORS ARE NOT RESPONSIBLE FOR ANY DAMAGE TO, OR LOSS OF, DATA OR OTHER INFORMATION STORED IN ANY MEDIA OR ANY PART OF ANY PRODUCT RETURNED TO EIZO OR DISTRIBUTORS FOR REPAIR.

EIZO AND DISTRIBUTORS MAKE NO FURTHER WARRANTIES, EXPRESSED OR IMPLIED, WITH RESPECT TO THE PRODUCT AND ITS QUALITY, PERFORMANCE, MERCHANTABILITY OR FITNESS FOR ANY PARTICULAR USE. IN NO EVENT SHALL EIZO OR DISTRIBUTORS BE LIABLE FOR ANY INCIDENTAL, INDIRECT, SPECIAL, CONSEQUENTIAL OR OTHER DAMAGE WHATSOEVER (INCLUDING, WITHOUT LIMITATION, DAMAGES FOR LOSS OF PROFIT, BUSINESS INTERRUPTION, LOSS OF BUSINESS INFORMATION, OR ANY OTHER PECUNIARY LOSS) ARISING OUT OF THE USE OR INABILITY TO USE THE PRODUCT OR IN ANY CONNECTION WITH THE PRODUCT, WHETHER BASED ON CONTRACT, TORT, NEGLIGENCE, STRICT LIABILITY OR OTHERWISE, EVEN IF EIZO OR DISTRIBUTORS HAVE BEEN ADVISED OF THE POSSIBILITY OF SUCH DAMAGES. THIS EXCLUSION ALSO INCLUDES ANY LIABILITY WHICH MAY ARISE OUT OF THIRD PARTY CLAIMS AGAINST THE ORIGINAL PURCHASER. THE ESSENCE OF THIS PROVISION IS TO LIMIT THE POTENTIAL LIABILITY OF EIZO AND DISTRIBUTORS ARISING OUT OF THIS LIMITED WARRANTY AND/OR SALES.

BEGRENZTE GARANTIE

EIZO Corporation (im Weiteren als „**EIZO**“ bezeichnet) und die Vertragsimporteure von EIZO (im Weiteren als „**Vertrieb(e)**“ bezeichnet) garantieren dem ursprünglichen Käufer (im Weiteren als „**Erstkäufer**“ bezeichnet), der das in diesem Dokument vorgegebene Produkt (im Weiteren als „**Produkt**“ bezeichnet) von EIZO oder einem Vertrieb erworben hat, gemäß den Bedingungen dieser beschränkten Garantie (im Weiteren als „**Garantie**“ bezeichnet), dass EIZO und der Vertrieb nach eigenem Ermessen das Produkt entweder kostenlos reparieren oder austauschen, falls der Erstkäufer innerhalb der Garantiefrist (weiter unten festgelegt) eine Fehlfunktion bzw. Beschädigung des Produkts feststellt, die während des normalen Gebrauchs des Produkts gemäß den Anweisungen des zum Lieferumfang des Produkts gehörenden Benutzerhandbuchs (im Weiteren als „**Benutzerhandbuch**“ bezeichnet) aufgetreten ist.

Die Dauer der Garantieleistung beträgt (i) fünf (5) Jahre ab dem Erstverkaufsdatum des Produkts oder (ii) 30.000 Betriebsstunden des Produkts (im Weiteren als „**Garantiefrist**“ bezeichnet). EIZO und die Vertriebe übernehmen über den Rahmen dieser Garantie hinaus hinsichtlich des Produkts keinerlei Haftung oder Verpflichtung dem Erstkäufer oder Dritten gegenüber.

EIZO und die Vertriebe verpflichten sich, Ersatzteile für das Produkt über einen Zeitraum von sieben (7) Jahren nach Einstellung der Produktion der Ersatzteile zu lagern bzw. anzubieten. EIZO und seine Vertriebspartner verpflichten sich, bei einer etwaigen Reparatur des Monitors ausschließlich Produkte gemäß den EIZO-Qualitätssicherungsstandards zu verwenden.

Diese Garantie gilt nur in Ländern oder Gebieten, in denen sich Vertriebe befinden. Die gesetzlichen Gewährleistungsrechte des Erstkäufers gegenüber dem Verkäufer werden durch diese Garantie nicht berührt.

EIZO und die Vertriebe besitzen im Rahmen dieser Garantie keinerlei Verpflichtung in den folgenden Fällen:

- (a) Produktdefekte, die auf Frachtschäden, Modifikation, Nachgestaltung, Missbrauch, Fehlbedienung, Unfälle, unsachgemäße Installation, Naturkatastrophen, fehlerhafte Wartung und/oder unsachgemäße Reparatur durch eine andere Partei als EIZO und die Vertriebe zurückzuführen sind.
- (b) Eine Inkompatibilität des Produkts aufgrund von technischen Neuerungen und/oder neuen Bestimmungen, die nach dem Kauf in Kraft treten.
- (c) Jegliche Verschlechterung des Sensors.
- (d) Jegliche Verschlechterung der Bildschirmleistung, die durch Verschleißteile wie das LCD-Panel und/oder die Hintergrundbeleuchtung usw. hervorgerufen werden (z.B. Veränderungen von Helligkeit oder Helligkeitsverteilung, Veränderungen von Farbe oder Farbverteilung, Pixeldefekte einschließlich von durchgebrannten Pixeln usw.).
- (e) Produktdefekte, die durch externe Geräte verursacht werden.
- (f) Jeglicher Defekt eines Produkts, dessen ursprüngliche Seriennummer geändert oder entfernt wurde.
- (g) Normale Abnutzung des Produkts, insbesondere von Verbrauchsteilen, Zubehörteilen und/oder Beilagen (z.B. Tasten, drehbare Teile, Kabel, Benutzerhandbuch usw.); sowie
- (h) Verformungen, Verfärbungen und/oder Verziehungen am Produktäußeren, einschließlich der Oberfläche des LCD-Panels.

Bei Inanspruchnahme der Garantieleistung ist der Erstkäufer verpflichtet, das Produkt auf eigene Kosten und in der Originalverpackung bzw. einer anderen geeigneten Verpackung, die einen gleichwertigen Schutz gegen Transportschäden bietet, an den örtlichen Vertrieb zu übersenden, wobei der Erstkäufer das Transportrisiko gegenüber Schäden und/oder Verlust trägt. Zum Zeitpunkt der Inanspruchnahme der Garantieleistung muss der Erstkäufer einen Verkaufsbeleg vorweisen, auf dem das Kaufdatum angegeben ist.

Die Garantiefrist für ein im Rahmen dieser Garantie ausgetauschtes und/oder repariertes Produkt erlischt nach Ablauf der ursprünglichen Garantiefrist.

EIZO ODER DIE EIZO-VERTRAGSIMPORTEURE HAFTEN NICHT FÜR ZERSTÖRTE DATENBESTÄNDE ODER DIE KOSTEN DER WIEDERBESCHAFFUNG DIESER DATENBESTÄNDE AUF JEDLICHEN DATENTRÄGERN ODER TEILEN DES PRODUKTS, DIE IM RAHMEN DER GARANTIE BEI EIZO ODER DEN EIZO-VERTRAGSIMPORTEUREN ZUR REPARATUR EINGEREICHT WURDEN.

EIZO UND DIE EIZO-VERTRAGSIMPORTEURE GEBEN WEDER EXPLIZITE NOCH IMPLIZITE GARANTIEEN IN BEZUG AUF DIESES PRODUKT UND SEINE QUALITÄT, LEISTUNG, VERKÄUFLICHKEIT ODER EIGNUNG FÜR EINEN BESTIMMTEN ZWECK. AUF KEINEN FALL SIND EIZO ODER DIE EIZO-VERTRAGSIMPORTEURE VERANTWORTLICH FÜR JEDLICHE ZUFÄLLIGE, INDIREKTE, SPEZIELLE, FOLGE- ODER ANDERE SCHÄDEN JEDLICHER ART (EINSCHLIESSLICH OHNE JEDE BEGRENZUNG SCHÄDEN BEZÜGLICH PROFITVERLUST, GESCHÄFTSUNTERBRECHUNG, VERLUST VON GESCHÄFTSINFORMATION ODER JEDLICHE ANDEREN FINANZIELLEN EINBUSSEN), DIE DURCH DIE VERWENDUNG DES PRODUKTES ODER DIE UNFÄHIGKEIT ZUR VERWENDUNG DES PRODUKTES ODER IN JEDLICHER BEZIEHUNG MIT DEM PRODUKT, SEI ES BASIEREND AUF VERTRAG, SCHADENSERSATZ, NACHLAESSIGKEIT, STRIKTE HAFTPFLICHT ODER ANDEREN FORDERUNGEN ENTSTEHEN, AUCH WENN EIZO UND DIE EIZO-VERTRAGSIMPORTEURE IM VORAUS ÜBER DIE MÖGLICHKEIT SOLCHER SCHÄDEN INFORMIERT WURDEN. DIESER AUSSCHLUSS ENTHÄLT AUCH JEDE HAFTPFLICHT, DIE AUS FORDERUNGEN DRITTER GEGEN DEN ERSTKÄUFER ENTSTEHEN KANN. ZWECK DIESER KLAUSEL IST ES, DIE HAFTUNG VON EIZO UND DEN VERTRIEBEN GEGENÜBER FORDERUNGEN ZU BEGRENZEN, DIE AUS DIESER BESCHRÄNKTEN GARANTIE UND/ODER DEM VERKAUF ENTSTEHEN KÖNNEN.

GARANTIE LIMITÉE

EIZO Corporation (ci-après dénommé « **EIZO** ») et les distributeurs autorisés par EIZO (ci-après dénommés « **Distributeurs** »), sous réserve et conformément aux termes de cette garantie limitée (ci-après dénommée « **Garantie** »), garantissent à l'acheteur initial (ci-après dénommé « **Acheteur initial** ») du produit spécifié dans la présente (ci-après dénommé « **Produit** ») acheté auprès d'EIZO ou de Distributeurs agréés EIZO, que EIZO et ses Distributeurs auront pour option de réparer ou remplacer gratuitement le Produit si l'Acheteur initial constate, pendant la Période de garantie (définie ci-dessous), qu'il y a un dysfonctionnement ou que le Produit a subi un dommage dans le cadre d'une utilisation normale du Produit conformément à la description du mode d'emploi qui accompagne le Produit (ci-après dénommé « **Manuel d'utilisation** »).

La période de cette Garantie est limitée à (i) cinq (5) ans à partir de la date d'achat du Produit ; ou, limitée jusqu'à l'expiration de (ii) 30 000 heures d'utilisation du Produit (ci-après dénommée « **Période de Garantie** »). EIZO et ses Distributeurs déclinent toute responsabilité ou obligation concernant ce Produit face à l'Acheteur initial ou à toute autre personne à l'exception de celles stipulées dans la présente Garantie.

EIZO et ses Distributeurs cesseront de tenir ou conserver en stock toute pièce de ce Produit après l'expiration de la période de sept (7) ans suivant l'arrêt de la production de telles pièces. Pour réparer le moniteur, EIZO et ses distributeurs utiliseront des pièces de rechange conformes à nos normes de contrôle qualité.

La Garantie est valable uniquement dans les pays ou les territoires où se trouvent les Distributeurs. La Garantie ne limite aucun des droits reconnus par la loi à l'Acheteur initial.

Nonobstant toute autre clause de cette Garantie, EIZO et ses Distributeurs n'auront d'obligation dans le cadre de cette Garantie pour aucun des cas énumérés ci-dessous :

- (a) Tout défaut du Produit résultant de dommages occasionnés lors du transport, d'une modification, d'une altération, d'un abus, d'une mauvaise utilisation, d'un accident, d'une installation incorrecte, d'un désastre, d'un entretien et/ou d'une réparation incorrects effectués par une personne autre que EIZO ou ses Distributeurs ;
- (b) Toute incompatibilité du Produit résultant d'améliorations techniques et/ou réglementations possibles ;
- (c) Toute détérioration du capteur ;
- (d) Toute détérioration des performances d'affichage causée par la détérioration des éléments consommables tels que le panneau LCD et/ou le rétroéclairage, etc. (par exemple des changements de luminosité, des changements de l'uniformité de la luminosité, des modifications de couleur, des changements de l'uniformité des couleurs, des défauts de pixels y compris des pixels brûlés, etc.);
- (e) Tout défaut du Produit causé par un appareil externe ;
- (f) Tout défaut d'un Produit sur lequel le numéro de série original a été altéré ou supprimé ;
- (g) Toute détérioration normale du Produit, particulièrement celle des consommables, des accessoires et/ou des pièces reliées au Produit (touches, éléments pivotants, câbles, Manuel d'utilisation etc.), et
- (h) Toute déformation, décoloration, et/ou gondolage de l'extérieur du Produit, y compris celle de la surface du panneau LCD.

Pour bénéficier d'un service dans le cadre de cette Garantie, l'Acheteur initial doit renvoyer le Produit port payé, dans son emballage d'origine ou tout autre emballage approprié offrant un degré de protection équivalent, au Distributeur local, et assumera la responsabilité des dommages et/ou perte possibles lors du transport. L'Acheteur initial doit présenter une preuve d'achat du Produit comprenant sa date d'achat pour bénéficier de ce service dans le cadre de la Garantie.

La Période de garantie pour tout Produit remplacé et/ou réparé dans le cadre de cette Garantie expirera à la fin de la Période de garantie initiale.

EIZO OU SES DISTRIBUTEURS NE SAURAIENT ÊTRE TENUS RESPONSABLES DES DOMMAGES OU PERTES DE DONNÉES OU D'AUTRES INFORMATIONS STOCKÉES DANS UN MÉDIA QUELCONQUE OU UNE AUTRE PARTIE DU PRODUIT RENVOYÉ À EIZO OU AUX DISTRIBUTEURS POUR RÉPARATION.

AUCUNE AUTRE GARANTIE, EXPLICITE OU TACITE, N'EST OFFERTE PAR EIZO ET SES DISTRIBUTEURS CONCERNANT LE PRODUIT ET SES QUALITÉS, PERFORMANCES, QUALITÉ MARCHANDE OU ADAPTATION À UN USAGE PARTICULIER. EN AUCUN CAS, EIZO OU SES DISTRIBUTEURS NE SERONT RESPONSABLES DES DOMMAGES FORTUITS, INDIRECTS, SPÉCIAUX, INDUITS, OU DE TOUT AUTRE DOMMAGE QUEL QU'IL SOIT (Y COMPRIS, SANS LIMITATION, LES DOMMAGES RÉSULTANT D'UNE PERTE DE PROFIT, D'UNE INTERRUPTION D'ACTIVITÉS, D'UNE PERTE DE DONNÉES COMMERCIALES, OU DE TOUT AUTRE MANQUE À GAGNER) RÉSULTANT DE L'UTILISATION OU DE L'INCAPACITÉ D'UTILISER LE PRODUIT OU AYANT UN RAPPORT QUELCONQUE AVEC LE PRODUIT, QUE CE SOIT SUR LA BASE D'UN CONTRAT, D'UN TORT, D'UNE NÉGLIGENCE, D'UNE RESPONSABILITÉ STRICTE OU AUTRE, MÊME SI EIZO OU SES DISTRIBUTEURS ONT ÉTÉ AVERTIS DE LA POSSIBILITÉ DE TELS DOMMAGES. CETTE LIMITATION INCLUT AUSSI TOUTE RESPONSABILITÉ QUI POURRAIT ÊTRE SOULEVÉE LORS DES RÉCLAMATIONS D'UN TIERS CONTRE L'ACHETEUR INITIAL. L'ESSENCE DE CETTE CLAUSE EST DE LIMITER LA RESPONSABILITÉ POTENTIELLE DE EIZO ET DE SES DISTRIBUTEURS RÉSULTANT DE CETTE GARANTIE LIMITÉE ET/OU DES VENTES.

GARANTÍA LIMITADA

EIZO Corporation (en lo sucesivo "**EIZO**") y sus distribuidores autorizados (en lo sucesivo los "**Distribuidores**"), con arreglo y de conformidad con los términos de esta garantía limitada (en lo sucesivo la "**Garantía**"), garantizan al comprador original (en lo sucesivo el "**Comprador original**") que compró el producto especificado en este documento (en lo sucesivo el "**Producto**") a EIZO o a sus Distribuidores, que EIZO y sus Distribuidores, a su propio criterio, repararán o sustituirán el Producto de forma gratuita si el Comprador original detecta dentro del periodo de la Garantía (indicado posteriormente) que el Producto no funciona correctamente o que se ha averiado durante el uso normal del mismo de acuerdo con las indicaciones del manual de instrucciones suministrado con el Producto (en lo sucesivo el "**Manual del usuario**").

El período de validez de esta Garantía está limitado a (i) cinco (5) años a partir de la fecha de compra del Producto o (ii) a 30.000 horas de uso del Producto (en adelante designado como el "**Periodo de Garantía**"). EIZO y sus Distribuidores no tendrán ninguna responsabilidad ni obligación con respecto al Producto para con el Comprador original ni para con terceros que no sean las estipuladas en la presente Garantía.

EIZO y sus Distribuidores no estarán obligados a suministrar cualquier recambio del Producto una vez pasados siete (7) años desde que se deje de fabricar el mismo. Para la reparación del monitor, EIZO y los distribuidores utilizarán repuestos que cumplan con nuestros estándares de control de calidad.

La Garantía es válida sólo en los países y territorios donde están ubicados los Distribuidores. La Garantía no restringe ningún derecho legal del Comprador original.

A pesar de las estipulaciones de esta Garantía, EIZO y sus Distribuidores no tendrán obligación alguna bajo esta Garantía en ninguno de los casos expuestos a continuación:

- (a) Cualquier defecto del Producto causado por daños en el transporte, modificación, alteración, abuso, uso incorrecto, accidente, instalación incorrecta, desastre, mantenimiento incorrecto y/o reparación indebida realizada por un tercero que no sea EIZO o sus Distribuidores.
- (b) Cualquier incompatibilidad del Producto debida a posibles innovaciones técnicas y/o reglamentaciones.
- (c) Cualquier deterioro del sensor.
- (d) Cualquier deterioro en el rendimiento de la visualización causado por fallos en las piezas consumibles como el panel LCD y/o la "Backlight", etc. (p. ej. cambios de brillo, cambios de uniformidad del brillo, cambios de color, cambios de uniformidad del color, defectos de píxeles, incluyendo píxeles muertos, etc.).
- (e) Cualquier defecto del Producto causado por un equipo externo.
- (f) Cualquier defecto del Producto en el que haya sido alterado o borrado el número de serie original.
- (g) Cualquier deterioro normal del Producto, y en particular de las piezas consumibles, accesorios y demás (p. ej. botones, piezas giratorias, cables, Manual del usuario, etc.).
- (h) Cualquier deformación, decoloración y/o alabeo del exterior del Producto incluida la superficie del panel LCD.

Para obtener servicio en los términos de esta Garantía, el Producto deberá ser enviado por el Comprador original, a su Distribuidor local, con el transporte previamente pagado, en el embalaje original u otro embalaje adecuado que ofrezca el mismo grado de protección, asumiendo el riesgo de daños y/o pérdida del Producto durante el transporte. El Comprador original deberá presentar un comprobante de compra del Producto en el que se refleje la fecha de compra del mismo cuando lo solicite el servicio de Garantía.

El Periodo de garantía para cualquier Producto reemplazado y/o reparado en los términos de esta Garantía expirará al vencer el Periodo de garantía original.

EIZO O LOS DISTRIBUIDORES AUTORIZADOS DE EIZO NO SE RESPONSABILIZAN DE NINGÚN DAÑO O PÉRDIDA QUE PUEDAN SUFRIR LOS DATOS U OTRA INFORMACIÓN ALMACENADA EN CUALQUIER MEDIO O CUALQUIER PARTE DE CUALQUIER PRODUCTO DEVUELTO A EIZO O A LOS DISTRIBUIDORES DE EIZO PARA SU REPARACIÓN.

EIZO Y LOS DISTRIBUIDORES AUTORIZADOS DE EIZO NO OFRECEN NINGUNA OTRA GARANTÍA, IMPLÍCITA NI EXPLÍCITA, CON RESPECTO AL PRODUCTO Y A SU CALIDAD, RENDIMIENTO, COMERCIABILIDAD E IDONEIDAD PARA CUALQUIER USO EN PARTICULAR. EN NINGÚN CASO SERÁN EIZO O LOS DISTRIBUIDORES AUTORIZADOS DE EIZO RESPONSABLES DE NINGÚN DAÑO EMERGENTE, INDIRECTO, ESPECIAL, INHERENTE O CUALQUIERA QUE SEA (INCLUYENDO, SIN LIMITACIÓN, DAÑOS POR LUCRO CESANTE, INTERRUPTIÓN DE LA ACTIVIDAD COMERCIAL, PÉRDIDA DE INFORMACIÓN COMERCIAL O CUALQUIER OTRA PÉRDIDA PECUNIARIA) QUE SE DERIVE DEL USO O IMPOSIBILIDAD DE USO DEL PRODUCTO O EN RELACIÓN CON EL PRODUCTO, YA SEA BASADO EN CONTRATO, POR AGRAVIO, NEGLIGENCIA, ESTRICTA RESPONSABILIDAD O CUALQUIERA QUE SEA, AUN CUANDO SE HAYA ADVERTIDO A EIZO O A LOS DISTRIBUIDORES DE EIZO DE LA POSIBILIDAD DE TALES DAÑOS. ESTA EXCLUSIÓN TAMBIÉN ABARCA CUALQUIER RESPONSABILIDAD QUE PUEDA DERIVARSE DE RECLAMACIONES HECHAS POR UN TERCERO CONTRA EL COMPRADOR ORIGINAL. LA ESENCIA DE ESTA ESTIPULACIÓN ES LIMITAR LA RESPONSABILIDAD POTENCIAL DE EIZO Y LOS DISTRIBUIDORES QUE PUDIERA DERIVARSE DE ESTA GARANTÍA LIMITADA Y/O VENTAS.

GARANZIA LIMITATA

EIZO Corporation (a cui si farà riferimento da qui in poi con “**EIZO**”) ed i Distributori autorizzati da EIZO (a cui si farà riferimento da qui in poi con “**Distributori**”) garantiscono, secondo i termini di questa garanzia limitata (a cui si farà riferimento da qui in poi con “**Garanzia**”) all’acquirente originale (a cui si farà riferimento da qui in poi con “**Acquirente originale**”) che ha acquistato il prodotto specificato in questo documento (a cui si farà riferimento da qui in poi con “**Prodotto**”) da EIZO o dai suoi Distributori, che EIZO e i distributori, a loro discrezione, ripareranno o sostituiranno il Prodotto senza addebito se l’Acquirente originale trova, entro il periodo della Garanzia (definito sotto), che il Prodotto malfunziona e si è danneggiato nel corso del suo normale utilizzo osservando le indicazioni del manuale di istruzioni allegato al Prodotto (a cui si farà riferimento da qui in poi con “**Manuale utente**”).

La presente Garanzia è limitata a (i) cinque (5) anni a partire dalla data d’acquisto del Prodotto o (ii) allo scadere di 30.000 ore d’utilizzo del Prodotto (a cui si farà riferimento da qui in poi con “**Periodo di Garanzia**”). EIZO e i suoi Distributori non si assumono alcuna responsabilità e non hanno alcun obbligo riguardo al Prodotto verso l’Acquirente originale o terzi diversi da quelli relativi a questa Garanzia.

EIZO e i suoi Distributori cesseranno di tenere o di conservare qualsiasi ricambio del Prodotto allo scadere di sette (7) anni dopo che la produzione di tali ricambi è stata terminata. Per la riparazione del monitor, EIZO e i Distributori utilizzeranno parti di ricambio conformi ai nostri standard di controllo della qualità.

La Garanzia è valida soltanto nei paesi dove ci sono i Distributori EIZO. La Garanzia non limita alcun diritto legale dell’Acquirente originale.

Indipendentemente da qualsiasi altra condizione di questa Garanzia, EIZO e i suoi Distributori non avranno alcun obbligo derivante da questa Garanzia in ognuno dei casi elencati di seguito:

- (a) Qualsiasi difetto del Prodotto causato da danni di trasporto, modifiche, alterazioni, abusi, usi impropri, incidenti, installazione errata, calamità, manutenzione errata e/o riparazioni improprie eseguite da terze parti che non siano EIZO o i suoi Distributori.
- (b) Qualsiasi incompatibilità del Prodotto dovuta a possibili innovazioni tecniche e/o normative.
- (c) Qualsiasi deterioramento del sensore.
- (d) Qualsiasi deterioramento delle prestazioni dello schermo causato dal deterioramento delle parti consumabili, come il pannello LCD e/o la retroilluminazione, ecc. (per esempio: i cambiamenti di luminosità, cambiamenti di uniformità della luminosità, i cambiamenti di colore, i cambiamenti di uniformità del colore, i difetti dei pixel, inclusi i pixel bruciati, ecc.).
- (e) Qualsiasi difetto del Prodotto causato da apparecchiature esterne.
- (f) Qualsiasi difetto del Prodotto in cui il numero di serie originale sia stato alterato o rimosso.
- (g) Qualsiasi normale deterioramento del Prodotto, in particolar modo nelle sue parti di consumo, accessori, e/o attacchi (per esempio: tasti, parti rotanti, cavi, Manuale dell’utente, ecc.).
- (h) Qualsiasi tipo di deformazione, scolorimento, e/o di involucro esterno del Prodotto inclusa la superficie del pannello LCD.

Per ricevere assistenza tecnica con questa Garanzia, l’Acquirente originale deve inviare il Prodotto, con trasporto pre-pagato, nella sua confezione originale o altra confezione adeguata che fornisce un livello analogo di protezione, assumendosi il rischio di danni e/o perdita in transito, al Distributore locale. L’Acquirente originale deve presentare la prova di acquisto che stabilisce la data di acquisto del Prodotto quando richiede servizio sotto Garanzia.

Il Periodo di garanzia per qualsiasi Prodotto sostituito e/o riparato sotto questa Garanzia scade alla fine del Periodo di garanzia originale.

EIZO O I SUOI DISTRIBUTORI NON SONO RESPONSABILI PER QUALSIASI DANNO O PERDITA DI DATI O ALTRE INFORMAZIONI MEMORIZZATI SU QUALSIASI SUPPORTO O QUALSIASI PARTE DI QUALSIASI PRODOTTO INVIATO A EIZO O I SUOI DISTRIBUTORI PER RIPARAZIONI.

EIZO E I SUOI DISTRIBUTORI NON OFFRONO ALCUNA GARANZIA ADDIZIONALE, IMPLICITA O ESPLICITA, RIGUARDO IL PRODOTTO E LA SUA QUALITÀ, PRESTAZIONI, VENDIBILITÀ O APPROPRIATEZZA PER QUALSIASI USO PARTICOLARE. IN NESSUN CASO EIZO O I DISTRIBUTORI EIZO AUTORIZZATI SARANNO RESPONSABILI PER QUALSIASI DANNO ACCIDENTALE, INDIRETTO, SPECIALE, CONSEGUENTE O DI QUALSIASI ALTRA NATURA (INCLUSI, SENZA LIMITI, DANNI PER PERDITA DI PROFITTI, INTERRUZIONE DELLE ATTIVITÀ, PERDITA DI INFORMAZIONI D’AFFARI O QUALSIASI ALTRA PERDITA PECUNIARIA) DERIVANTI DALL’USO O DALL’IMPOSSIBILITÀ DI USARE IL PRODOTTO O IN QUALSIASI RELAZIONE AL PRODOTTO, SIA SU BASE DI CONTRATTO, TORTO, NEGLIGENZA, STRETTA RESPONSABILITÀ O ALTRIMENTI, ANCHE SE EIZO O I DISTRIBUTORI EIZO AUTORIZZATI SONO STATI AVVERTITI DELLA POSSIBILITÀ DI TALI DANNI. QUESTA ESCLUSIONE INCLUDE ANCHE QUALSIASI RESPONSABILITÀ CHE POSSA INSORGERE DA RECLAMI DI TERZI CONTRO L’ACQUIRENTE ORIGINALE. L’ESSENZA DI QUESTO PROVVEDIMENTO È LIMITARE LA RESPONSABILITÀ POTENZIALE DI EIZO E DEI DISTRIBUTORI DERIVANTE DA QUESTA GARANZIA LIMITATA E/O DALLE VENDITE.

BEGRÄNSAD GARANTI

EIZO Corporation (nedan kallat "**EIZO**") och EIZOs auktoriserade distributörer (nedan kallade "**Distributörer**") garanterar i enlighet med villkoren i denna begränsade garanti (nedan kallad "**Garantin**") den ursprunglige köparen (nedan kallad den "**Ursprunglige köparen**") som köpte den i dokumentet specificerade produkten (nedan kallad "**Produkten**") från EIZO eller Distributörer, att EIZO eller Distributörer enligt eget gottfinnande kostnadsfritt antingen reparera eller byta ut den defekta Produkten om den Ursprunglige köparen inom Garantiperioden (definieras nedan) upptäcker att Produkten fungerar felaktigt eller skadas under normal användning av Produkten i enlighet med beskrivningen i bruksanvisningen (nedan kallad "**Bruksanvisning**").

Giltighetsperioden för denna garanti är begränsad till (i) fem (5) år från datumet för Produktens inköp eller, om detta inträffar tidigare, begränsat till utlöpanget av (ii) 30 000 timmars användning av Produkten (häri kallad "**Garantiperioden**"). EIZO och Distributörer ska inte under några villkor ha något annat ansvar än vad som anges i denna garanti gällande Produkten i relation till den Ursprunglige köparen eller tredje part.

EIZO och Distributörer kommer att upphöra med lagerhållning av Produktens delar efter sju (7) år efter att produktionen av dessa delar upphört. Nät skärmen repareras använder EIZO och distributörer reservdelar som uppfyller våra kvalitetsstandarder.

Garantin är endast giltig i de länder där det finns Distributörer. Garantin begränsar inte några av den Ursprunglige köparens lagstadgade rättigheter.

Oavsett andra villkor i denna garanti ska inte EIZO Distributörer under några villkor ha något ansvar i något av de fall som beskrivs nedan:

- (a) När någon bristfällighet hos Produkten kan härledas till att ha uppstått vid frakt, modifiering, ändring, felaktigt handhavande, olycka, felaktig installation, katastrof, felaktigt underhåll och/eller felaktig reparation utförd av tredje part annan än EIZO och Distributörer.
- (b) Alla former av inkompatibilitet hos Produkten på grund av möjliga tekniska innovationer och/eller bestämmelser.
- (c) Alla försämringar av sensorn.
- (d) Alla försämringar av bildens prestanda beroende på förbrukningsdelar så som LCD-panel och/eller bakgrundsbelysning etc. (t.ex. ändringar i ljusstyrka, jämnhet i ljusstyrka, färg, färgjämnhet, defekta pixlar och/eller fast lysande pixlar etc.).
- (e) Alla defekter hos Produkten som orsakats av extern utrustning.
- (f) Alla defekter hos Produkten på vilken det ursprungliga serienumret har ändrats eller avlägsnats.
- (g) All normal försämring av Produkten, speciellt förbrukningsartiklar, tillbehör och/eller yttre delar (t.ex. knappar, roterande delar, kablar, Bruksanvisningen etc.).
- (h) Varje deformation, missfärgning och/eller skevhet av Produktens yttre inklusive ytan på LCD-panelen.

För att erhålla service under denna garanti måste den Ursprunglige köparen (med hänseende till risken för skada och/eller förlust under transport) leverera Produkten till närmaste Distributör med förebetalad frakt, i dess ursprungliga förpackning eller annan fullgod förpackning som ger likvärdigt skydd. Den Ursprunglige köparen måste kunna visa inköpsbevis för Produkten som klargör Produktens inköpsdatum vid begäran av garantiservice.

Garantiperioden för alla utbytta och/eller reparerade produkter under denna garanti skall upphöra vid utgången av den ursprungliga Garantiperioden.

EIZO ELLER DISTRIBUTÖRER ÄR INTE ANSVARIGA FÖR NÅGON FORM AV SKADA ELLER FÖRLUST AV DATA ELLER ANNAN INFORMATION SOM HAR LAGRATS I NÅGON FORM AV MEDIA ELLER ANNAN DEL AV NÅGON PRODUKT SOM HAR RETURNERATS TILL EIZO ELLER DISTRIBUTÖRER FÖR REPARATION.

EIZO OCH DISTRIBUTÖRERNA GARANTERAR INGET, UTTRYCKLIGEN ELLER UNDERFÖRSTÅTT, VAD BETRÄFFAR PRODUKTEN OCH DESS KVALITET, PRESTANDA, SÄLJBARHET ELLER LÄMPLIGHET FÖR NÅGON FORM AV SPECIELL ANVÄNDNING. UNDER INGA OMSTÄNDIGHETER SKALL EIZO ELLER DISTRIBUTÖRERNA HÅLLAS ANSVARIGA FÖR NÅGRA SOM HELST UNDERORDNADE, INDIREKTA, SPECIELLA, DÄRAV FÖLJANDE ELLER ÖVRIGA SKADOR (INKLUSIVE, UTAN BEGRÄNSNING TILL, SKADOR FÖR FÖRLUST AV INKOMST, AVBRUTEN AFFÄRSRÖRELSE, FÖRLUST AV AFFÄRSINFORMATION ELLER ANNAN SÄRSKILD FÖRLUST) SOM UPPSTÅTT SOM ETT RESULTAT AV ANVÄNDNING ELLER OFÖRMÅGA ATT ANVÄNDA PRODUKTEN ELLER I NÅGON FORM AV ANSLUTNING TILL PRODUKTERNA, VARE SIG DETTA GRUNDAS PÅ KONTRAKT, ÅTALBAR HANDLING, FÖRSUMLIGHET, ANSVARSSKYLDIGHET ELLER ANNAT, ÄVEN OM EIZO ELLER DISTRIBUTÖRERNA HAR INFORMERATS BETRÄFFANDE MÖJLIGHET ATT SÅDANA SKADOR FÖRELIGGER. DETTA UNDANTAG OMFATTAR ÄVEN ALL FORM AV ANSVARSSKYLDIGHET SOM KAN UPPSTÅ GENOM EN TREDJE PARTS ANSPRÅK GENTEMOT DEN URSPRUNGLIGE KÖPAREN. GRUNDBESTÅNDSDELEN I BESTÄMMELEN ÄR ATT BEGRÄNSA DET EVENTUELLA ANSVARSTAGANDET FÖR EIZO OCH DISTRIBUTÖRERNA SOM KAN UPPSTÅ GENOM DENNA BEGRÄNSADE GARANTI OCH/ELLER FÖRSÄLJNING.

ΠΕΡΙΟΡΙΣΜΕΝΗ ΕΓΓΥΗΣΗ

Η EIZO Corporation (στο εξής «**EIZO**») και οι διανομείς που εξουσιοδοτεί η EIZO (στο εξής «**Διανομείς**») παρέχουν εγγύηση, υποκειμένη και σύμφωνα με τους όρους της παρούσας περιορισμένης εγγύησης (στο εξής «**Εγγύηση**»), στον αρχικό αγοραστή (στο εξής «**Αρχικός Αγοραστής**») ο οποίος αγόρασε το προϊόν που καθορίζεται στο παρόν έγγραφο (στο εξής «**Προϊόν**») από την EIZO ή τους Διανομείς, η οποία εξασφαλίζει ότι η EIZO και οι Διανομείς, σύμφωνα με τη διακριτή ευχέρειά τους, είτε θα επισκευάσουν είτε θα αντικαταστήσουν το Προϊόν χωρίς χρέωση εάν ο Αρχικός Αγοραστής αντιληφθεί εντός της Περιόδου Εγγύησης (ορίζεται κατωτέρω) ότι το Προϊόν δυσλειτουργεί ή έχει υποστεί βλάβη κατά τη διάρκεια κανονικής χρήσης του Προϊόντος σύμφωνα με την περιγραφή στο εγχειρίδιο χρήσης που συνοδεύει το Προϊόν (στο εξής «**Εγχειρίδιο Χρήστη**»).

Η περίοδος της παρούσας Εγγύησης είναι (i) πέντε (5) έτη από την ημερομηνία αγοράς του Προϊόντος, ή, στη λήξη των (ii) 30.000 ωρών χρήσης του Προϊόντος (στο εξής «**Περίοδος Εγγύησης**»). Η EIZO και οι Διανομείς δεν φέρουν καμία ευθύνη ή υποχρέωση όσον αφορά το Προϊόν σε σχέση με τον Αρχικό Αγοραστή ή οποιοδήποτε τρίτο μέρος, ούτε άλλη ευθύνη διαφορετική από αυτήν που παρέχεται στην παρούσα Εγγύηση.

Η EIZO και οι Διανομείς θα παύσουν να διατηρούν ή να αποθηκεύουν τυχόν εξαρτήματα του Προϊόντος κατόπιν της λήξης των επτά (7) ετών μετά τη διακοπή της παραγωγής τέτοιων εξαρτημάτων. Κατά την επισκευή της οθόνης, η EIZO και οι Διανομείς θα χρησιμοποιήσουν ανταλλακτικά επισκευής που συμμορφώνονται με τα πρότυπα μας για τη Διασφάλιση Ποιότητας.

Η Εγγύηση ισχύει μόνο σε χώρες ή περιοχές όπου βρίσκονται οι Διανομείς. Η Εγγύηση δεν περιορίζει οποιαδήποτε νόμιμα δικαιώματα του Αρχικού Αγοραστή.

Λαμβανομένης υπόψη κάθε διάταξης της παρούσας Εγγύησης, η EIZO και οι Διανομείς δεν θα έχουν καμία απολύτως υποχρέωση σύμφωνα με την παρούσα Εγγύηση σε οποιαδήποτε από τις περιπτώσεις που διατυπώνονται κατωτέρω:

- (α) Τυχόν ελάττωμα του Προϊόντος που προκαλείται από ζημιά κατά τη μεταφορά, τροποποίηση, αλλαγή, κατάχρηση, λανθασμένη χρήση, ατύχημα, λανθασμένη εγκατάσταση, καταστροφή, εσφαλμένη συντήρηση ή/και λανθασμένη επισκευή από τρίτο μέρος εκτός της EIZO και των Διανομέων,
- (β) Τυχόν ασυμβατότητα του Προϊόντος λόγω πιθανών τεχνικών καινοτομιών ή/και κανονισμών,
- (γ) Τυχόν επιδείνωση του αισθητήρα,
- (δ) Τυχόν επιδείνωση της απόδοσης οθόνης που προκαλείται από τη φθορά αναλώσιμων εξαρτημάτων όπως της οθόνης LCD ή/και του φωτός υποβάθρου, κτλ. (π.χ. αλλαγές στη φωτεινότητα, αλλαγές στην ομοιομορφία φωτεινότητας, αλλαγές στο χρώμα, αλλαγές στην ομοιομορφία χρώματος, ελαττώματα σε pixel περιλαμβανομένων των καμένων pixel, κτλ.),
- (ε) Τυχόν ελάττωμα του Προϊόντος που προκαλείται από εξωτερικό εξοπλισμό,
- (στ) Τυχόν ελάττωμα του Προϊόντος στο οποίο έχει τροποποιηθεί ή αφαιρεθεί ο γνήσιος αριθμός σειράς,
- (ζ) Τυχόν φυσιολογική φθορά του προϊόντος, ιδιαίτερα αυτής των αναλώσιμων, των αξεσουάρ ή/και των προσαρτημάτων (π.χ. κουμπιά, περιστρεφόμενα μέρη, καλώδια, Εγχειρίδιο Χρήστη, κτλ.), και
- (η) Τυχόν παραμόρφωση, αποχρωματισμό ή/και διαστρέβλωση του εξωτερικού μέρους του προϊόντος, περιλαμβανομένης της επιφάνειας της οθόνης LCD.

Ο Αρχικός Αγοραστής για να δικαιούται υπηρεσίες επισκευής σύμφωνα με την Εγγύηση, θα πρέπει να παραδώσει το Προϊόν, με πληρωμένα τα μεταφορικά έξοδα, στην αρχική του συσκευασία ή σε άλλη επαρκή συσκευασία με ισότιμο βαθμό προστασίας, αναλαμβάνοντας τον κίνδυνο βλάβης ή/και απώλειας κατά τη μεταφορά, στον τοπικό Διανομέα. Ο Αρχικός Αγοραστής όταν ζητά υπηρεσίες επισκευής σύμφωνα με την Εγγύηση, θα πρέπει να προσκομίζει την απόδειξη αγοράς του Προϊόντος και την ημερομηνία της αγοράς.

Η Περίοδος Εγγύησης για οποιοδήποτε αντικατεστημένο ή/και επισκευασμένο προϊόν σύμφωνα με την παρούσα Εγγύηση λήγει στο τέλος της αρχικής Περιόδου Εγγύησης.

Η EIZO Ή ΟΙ ΔΙΑΝΟΜΕΙΣ ΔΕΝ ΕΥΘΥΝΟΝΤΑΙ ΓΙΑ ΟΠΟΙΟΔΗΠΟΤΕ ΒΛΑΒΗ Ή ΑΠΩΛΕΙΑ ΔΕΔΟΜΕΝΩΝ Ή ΑΛΛΩΝ ΠΛΗΡΟΦΟΡΙΩΝ ΠΟΥ ΑΠΟΘΗΚΕΥΟΝΤΑΙ ΣΕ ΟΠΟΙΟΔΗΠΟΤΕ ΜΕΣΟ Ή ΟΠΟΙΟΔΗΠΟΤΕ ΑΛΛΟ ΜΕΡΟΣ ΣΕ ΟΠΟΙΟΔΗΠΟΤΕ ΠΡΟΪΟΝ ΠΟΥ ΕΠΙΣΤΡΕΦΕΤΑΙ ΣΤΗΝ EIZO Ή ΣΕ ΔΙΑΝΟΜΕΑ ΓΙΑ ΕΠΙΣΚΕΥΗ.

Η EIZO ΚΑΙ ΟΙ ΔΙΑΝΟΜΕΙΣ ΔΕΝ ΠΑΡΕΧΟΥΝ ΚΑΜΙΑ ΠΕΡΑΙΤΕΡΩ ΕΓΓΥΗΣΗ, ΡΗΤΗ Ή ΣΥΝΕΠΑΓΟΜΕΝΗ, ΟΣΟΝ ΑΦΟΡΑ ΤΟ ΠΡΟΪΟΝ ΚΑΙ ΤΗΝ ΠΟΙΟΤΗΤΑ, ΤΗΝ ΑΠΟΔΟΣΗ, ΤΗΝ ΕΜΠΟΡΕΥΣΙΜΟΤΗΤΑ Ή ΤΗΝ ΚΑΤΑΛΛΗΛΟΤΗΤΑ ΤΟΥ ΓΙΑ ΟΠΟΙΟΔΗΠΟΤΕ ΣΥΓΚΕΚΡΙΜΕΝΗ ΧΡΗΣΗ. ΣΕ ΚΑΜΙΑ ΠΕΡΙΠΤΩΣΗ Η EIZO Ή ΟΙ ΔΙΑΝΟΜΕΙΣ ΔΕΝ ΘΑ ΕΥΘΥΝΟΝΤΑΙ ΓΙΑ ΚΑΜΙΑ ΑΠΟΛΥΤΩΣ ΤΥΧΑΙΑ, ΕΜΜΕΣΗ, ΕΙΔΙΚΗ, ΣΥΝΕΠΑΓΟΜΕΝΗ Ή ΑΛΛΗ ΒΛΑΒΗ (ΠΕΡΙΛΑΜΒΑΝΟΜΕΝΩΝ, ΜΕΤΑΞΥ ΑΛΛΩΝ, ΒΛΑΒΩΝ Ή ΑΠΩΛΕΙΑΣ ΚΕΡΔΩΝ, ΔΙΑΚΟΠΗΣ ΕΠΙΧΕΙΡΗΜΑΤΙΚΩΝ ΔΡΑΣΤΗΡΙΟΤΗΤΩΝ, ΑΠΩΛΕΙΑΣ ΕΠΙΧΕΙΡΗΜΑΤΙΚΩΝ ΠΛΗΡΟΦΟΡΙΩΝ Ή ΤΥΧΟΝ ΑΛΛΗΣ ΧΡΗΜΑΤΙΚΗΣ ΑΠΩΛΕΙΑΣ) ΠΟΥ ΠΡΟΚΥΠΤΕΙ ΑΠΟ ΤΗ ΧΡΗΣΗ Ή ΤΗΝ ΑΝΙΚΑΝΟΤΗΤΑ ΧΡΗΣΗΣ ΤΟΥ ΠΡΟΪΟΝΤΟΣ Ή ΤΥΧΟΝ ΑΛΛΗΣ ΣΥΝΔΕΣΗΣ ΜΕ ΤΟ ΠΡΟΪΟΝ, ΕΙΤΕ ΒΑΣΙΖΕΤΑΙ ΣΕ ΣΥΜΒΟΛΑΙΟ, ΒΛΑΒΗ, ΑΜΕΛΕΙΑ, ΑΥΣΤΗΡΗ ΕΥΘΥΝΗ Ή ΕΙΔΑΛΛΩΣ, ΑΚΟΜΗ ΚΙ ΕΑΝ Η EIZO Ή ΟΙ ΔΙΑΝΟΜΕΙΣ ΕΝΗΜΕΡΩΘΟΥΝ ΓΙΑ ΤΗΝ ΠΙΘΑΝΟΤΗΤΑ ΤΕΤΟΙΩΝ ΖΗΜΙΩΝ. Η ΕΞΑΙΡΕΣΗ ΑΥΤΗ ΠΕΡΙΛΑΜΒΑΝΕΙ ΕΠΙΣΗΣ ΟΠΟΙΟΔΗΠΟΤΕ ΕΥΘΥΝΗ ΕΝΔΕΧΕΤΑΙ ΝΑ ΠΡΟΚΥΨΕΙ ΑΠΟ ΑΞΙΩΣΕΙΣ ΤΡΙΤΟΥ ΜΕΡΟΥΣ ΚΑΤΑ ΤΟΥ ΑΡΧΙΚΟΥ ΑΓΟΡΑΣΤΗ. Η ΟΥΣΙΑ ΤΟΥ ΟΡΟΥ ΑΥΤΟΥ ΕΙΝΑΙ ΝΑ ΠΕΡΙΟΡΙΣΕΙ ΤΗΝ ΠΙΘΑΝΗ ΕΥΘΥΝΗ ΤΗΣ EIZO ΚΑΙ ΤΩΝ ΔΙΑΝΟΜΕΩΝ ΠΟΥ ΠΡΟΚΥΠΤΕΙ ΑΠΟ ΤΗΝ ΠΑΡΟΥΣΑ ΕΓΓΥΗΣΗ Ή/ΚΑΙ ΤΙΣ ΠΩΛΗΣΕΙΣ.

ОГРАНИЧЕННАЯ ГАРАНТИЯ

EIZO Corporation (называемая в дальнейшем **“EIZO”**) и авторизованные EIZO дистрибуторы (называемые в дальнейшем **“Дистрибуторы”**) гарантируют, в соответствии с условиями и пунктами этой ограниченной гарантии (называемой в дальнейшем **“Гарантия”**), первичному покупателю (называемому в дальнейшем **“Первоначальный покупатель”**), который приобрел у EIZO или Дистрибуторов продукт, указанный в этом документе (называемый в дальнейшем **“Продукт”**), что EIZO или Дистрибуторы на свое усмотрение либо бесплатно отремонтируют, либо бесплатно заменят Продукт, если Первоначальный покупатель признает в пределах Гарантийного срока (определенного ниже), что Продукт неисправен или он поврежден процессе нормального использования продукта в соответствии с описанием в инструкции по эксплуатации, прилагаемой к Продукту (называемой в дальнейшем **“Руководство пользователя”**).

Гарантийный период ограничен сроком (i) пять (5) лет от даты приобретения Продукта или ограничен сроком (ii) 30 000 часов использования Продукта (называемый в дальнейшем **“Гарантийный период”**). EIZO и Дистрибуторы не несут никакой ответственности и не берут обязательств относительно Продукта по отношению к Первоначальному покупателю или по отношению к любым третьим сторонам, кроме обязательств, оговоренных в этой Гарантии.

EIZO и Дистрибуторы прекратят хранение или складирование любых деталей Продукта по истечении семи (7) лет после прекращения производства таких деталей. В случае ремонта монитора EIZO и Дистрибуторы будут использовать запчасти, которые соответствуют нашим стандартам QC (контроль качества).

Гарантия действительна только в странах или регионах, где расположены Дистрибуторы. Гарантия не ограничивает никакие законные права Первоначального покупателя.

Несмотря на другие условия этой Гарантии EIZO и Дистрибуторы не несут никаких обязательств согласно этой Гарантии в любом из перечисленных ниже случаев:

- (а) Любые дефекты Продукта, вызванные повреждениями при перевозке, модификацией, изменением, неправильным обращением, неправильным использованием, авариями, неправильной установкой, стихийными бедствиями, неправильным уходом и/или неправильным ремонтом третьей стороной, отличной от EIZO или Дистрибуторов;
- (б) Любые несовместимости Продукта из-за технических усовершенствований и/или изменения технических норм;
- (в) Любое повреждение датчика;
- (г) Любые ухудшения работы дисплея, вызванные изнашиванием невосстановимых частей, таких как панель ЖКД и/или подсветка и т.д. (например, изменение в яркости, изменение в равномерности яркости, изменение в цветности, изменение в равномерности цветности, изменение в пикселях, включая выгоревшие пиксели и т.д.);
- (д) Любые дефекты Продукта, вызванные внешним оборудованием;
- (е) Любые дефекты Продукта, при которых оригинальный серийный номер был изменен или удален;
- (ж) Любые естественные ухудшения продукта, в частности, вызванные износом расходных частей, принадлежностей и/или приспособлений (например, кнопок, вращающихся частей, кабелей, Руководства пользователя и т.д.); и
- (з) Любые деформации, изменения цвета и/или коробления внешней поверхности продукта, включая поверхность панели ЖКД.

Чтобы получить техническое обслуживание в рамках Гарантии, Первоначальный покупатель должен доставить Продукт местному Дистрибутору, оплатив перевозку, в его оригинальной упаковке или в другой соответствующей упаковке, обеспечивающей равноценную степень защиты, принимая во внимание риск повреждения и/или утерю при транспортировке. При запросе технического обслуживания в рамках Гарантии Первоначальный покупатель должен предоставить свидетельство покупки продукта и даты покупки.

Гарантийный период для любого замененного и/или отремонтированного продукта в рамках Гарантии истекает в конце завершения срока действия оригинального Гарантийного периода.

EIZO ИЛИ ДИСТРИБУТОРЫ НЕ НЕСУТ ОТВЕТСТВЕННОСТИ ЗА ЛЮБЫЕ ПОВРЕЖДЕНИЯ ИЛИ УТЕРЮ ДАННЫХ ИЛИ ДРУГОЙ ИНФОРМАЦИИ, ХРАНЯЩИХСЯ НА КАКИХ-ЛИБО НОСИТЕЛЯХ ИНФОРМАЦИИ ИЛИ НА ЛЮБЫХ ДРУГИХ ЧАСТЯХ ПРОДУКТА, КОТОРЫЙ ВОЗВРАЩЕН EIZO ИЛИ ДИСТРИБУТОРАМ ДЛЯ РЕМОНТА.

EIZO И ДИСТРИБУТОРЫ НЕ ДАЮТ НИКАКОЙ ДАЛЬНЕЙШЕЙ ГАРАНТИИ, ВЫРАЖЕННОЙ ИЛИ ПОДРАЗУМЕВАЕМОЙ, ОТНОСИТЕЛЬНО ПРОДУКТА И ЕГО КАЧЕСТВА, ТЕХНИЧЕСКИХ ХАРАКТЕРИСТИК, ТОВАРНОСТИ ИЛИ СООТВЕТСТВИЯ ДЛЯ КАКОГО-ЛИБО ОПРЕДЕЛЕННОГО ИСПОЛЬЗОВАНИЯ. НИ ПРИ КАКИХ УСЛОВИЯХ EIZO ИЛИ ДИСТРИБУТОРЫ НЕ НЕСУТ ОТВЕТСТВЕННОСТИ ЗА ЛЮБОЙ СЛУЧАЙНЫЙ, КОСВЕННЫЙ, СПЕЦИАЛЬНЫЙ, ПОБОЧНЫЙ ИЛИ ИНОЙ УЩЕРБ (ВКЛЮЧАЯ, БЕЗ ОГРАНИЧЕНИЙ, УЩЕРБ ИЗ-ЗА НЕПОЛУЧЕННОЙ ПРИБЫЛИ, ПРЕРЫВАНИЯ БИЗНЕСА, ПОТЕРИ КОММЕРЧЕСКОЙ ИНФОРМАЦИИ ИЛИ ЛЮБЫЕ ДРУГИЕ ФИНАНСОВЫЕ ПОТЕРИ), ВОЗНИКШИЙ ИЗ-ЗА ИСПОЛЬЗОВАНИЯ ИЛИ НЕВОЗМОЖНОСТИ ИСПОЛЬЗОВАТЬ ПРОДУКТ ИЛИ В ЛЮБОЙ ДРУГОЙ СВЯЗИ С ПРОДУКТОМ, ЛИБО ОСНОВАННЫЙ НА КОНТРАКТНЫХ ОТНОШЕНИЯХ, ГРАЖДАНСКИХ ПРАВОНАРУШЕНИЯХ, НЕБРЕЖНОСТИ, ПРИЧИНЕНИЯ УЩЕРБА ТРЕТЬЕЙ СТОРОНЕ ИЛИ ЧЕМ-ЛИБО ЕЩЕ, ДАЖЕ ЕСЛИ EIZO ИЛИ ДИСТРИБУТОРЫ БЫЛИ УВЕДОМЛЕННЫ О ВОЗМОЖНОСТИ ТАКОГО УЩЕРБА. ЭТО ИСКЛЮЧЕНИЕ ТАКЖЕ ВКЛЮЧАЕТ ЛЮБЫЕ ОБЯЗАТЕЛЬСТВА, КОТОРЫЕ МОГУТ ВОЗНИКНУТЬ В РЕЗУЛЬТАТЕ ТРЕБОВАНИЙ ТРЕТЬЕЙ СТОРОНЫ В ОТНОШЕНИИ ПЕРВОНАЧАЛЬНОГО ПОКУПАТЕЛЯ. СУЩЕСТВОМ ЭТОГО ПОЛОЖЕНИЯ ЯВЛЯЕТСЯ ОГРАНИЧЕНИЕ ПОТЕНЦИАЛЬНОЙ ОТВЕТСТВЕННОСТИ EIZO И ДИСТРИБУТОРОВ, ВОЗНИКАЮЩЕЙ ИЗ-ЗА ЭТОЙ ОГРАНИЧЕННОЙ ГАРАНТИИ И/ИЛИ ПРОДАЖ.

有限责任保证书

EIZO Corporation（以下简称“**EIZO**”）和 EIZO 授权的经销商（以下简称“**经销商**”），接受并依照本有限责任保证书（以下简称“**保证书**”）之条款，向从 EIZO 和经销商购买本文中所规定产品（以下简称“**产品**”）的原买方（以下称“**原买方**”）提供保证：在保证期内（规定如下），如果原买方发现按本产品所附使用说明书（以下简称“**用户手册**”）所述方式正常使用本产品过程中，本产品出现故障或损坏，EIZO 和经销商根据其独立的判断免费修理或更换该产品。

本保证期限定为 (i) 自本产品购买之日起的五 (5) 年期间或限定为到达 (ii) 使用本产品 3 万小时的期限（以下简称“**保证期限**”）。EIZO 和经销商将不向原买方或任何第三方承担本保证书所规定之外的与本产品有关的任何责任或义务。

本产品的任何部件停产七 (7) 年后，EIZO 和经销商将不再保留或保管任何这类部件。维修显示器时，EIZO 与经销商将使用符合我方质量控制标准的替换零件。

本保证书仅对于设有经销商的国家或地区有效。本保证书并不限定原买方的任何法律权利。

无论本保证书的任何其他条款如何规定，对于任何下列情况之一，EIZO 和经销商将不承担本保证书规定责任：

- (a) 由于运输损害、改装、改动、滥用、误用、意外事故、错误安装、灾害、维护不善和 / 或由除 EIZO 和经销商以外的第三方进行不适当的修理造成本产品的任何故障。
- (b) 由于可能发生的技术变更和 / 或调整造成本产品的任何不兼容性。
- (c) 传感器的任何劣化。
- (d) 由于诸如液晶显示屏 (LCD) 和 / 或背灯等消耗品部件的老化造成的任何显示性能低劣（如亮度变化、亮度均一性变化、色彩变化、色彩均一性变化、如烧伤像素等像素缺陷）。
- (e) 因外部设备造成本产品的任何故障。
- (f) 因本产品的原序号被改变或消除造成本产品的任何故障。
- (g) 本产品的任何正常老化，尤其是消耗品、附件和 / 或附加装置（如按钮、旋转部件、电缆、用户手册等）、以及
- (h) 本产品表面包括液晶显示屏 (LCD) 表面的任何变形、变色和 / 翘曲。

为了获得本保证书规定的服务，原买方必须使用原包装或其他具有同等保护程度的适当包装将本产品运送到当地的经销商，并且预付运费，承担运输中的损坏和 / 或损失的风险。要求提供本保证书规定的服务时，原买方必须提交购买本产品和标明此购买日期的证明。

按本保证书规定进行了更换和 / 或修理的任何产品的保证期限，将在原保证期限结束时终止。

在返回给 EIZO 和经销商进行修理后，任何产品的任何媒体或任何部件中储存的数据或其他信息发生任何损坏或损失，对此 EIZO 和经销商将不承担责任。

对于本产品及其质量、性能、可销售性以及对于特殊用途的适合性，EIZO 和经销商不提供其他任何明示或暗示的保证。因使用本产品或无法使用本产品或因与本产品有任何关系（无论是否根据合同）而造成：任何附带的、间接的、特殊的、随之发生的或其他的损害（包括但不限于：利润损失、业务中断、业务信息丢失或其他任何金钱损失）以及侵权行为、过失、严格赔偿责任或其他责任，即使已经向 EIZO 和经销商提出了发生这些损害的可能性，对此 EIZO 和经销商概不承担责任。本免责条款还包括因第三方向原买方提出索赔而可能发生的任何责任。本条款的本质是限定由于本有限责任保证书和 / 或销售本产品所发生的 EIZO 和经销商的潜在责任。

Recycling Information

Recycling Information

This product, when disposed of, is supposed to be collected and recycled according to your country's legislation to reduce environmental burden. When you dispose of this product, please contact a distributor or an affiliate in your country.

The contact addressees are listed on the EIZO website below.

www.eizoglobal.com

For recycling information for customers in Switzerland, please refer to the following website.

www.swico.ch

Informationen zum Thema Recycling

Dieses Produkt muss gemäß den Vorschriften Ihres Landes zur Entlastung der Umwelt recyclet werden. Wenden Sie sich bei der Entsorgung dieses Produkts an einen Verteiler oder eine Tochtergesellschaft in Ihrem Land.

Die Adressen zur Kontaktaufnahme sind auf der unten angegebenen Website von EIZO aufgeführt.

www.eizoglobal.com

Kunden in der Schweiz entnehmen Informationen zum Recycling der folgenden Website:

www.swico.ch

Informations sur le recyclage

Ce produit doit être jeté aux points de collecte prévus à cet effet et recyclé conformément à la législation de votre pays, afin de réduire l'impact sur l'environnement. Lorsque vous jetez ce produit, veuillez contacter un distributeur ou une société affiliée de votre pays.

Les adresses des distributeurs sont répertoriées sur le site Web EIZO ci-dessous.

www.eizoglobal.com

Pour les clients en Suisse, veuillez consulter le site Web suivant afin d'obtenir des informations sur le recyclage.

www.swico.ch

Información sobre reciclaje

Este producto debe desecharse y reciclarse según la legislación del país para reducir el impacto medioambiental. Cuando desee deshacerse de este producto, póngase en contacto con un distribuidor o una filial de su país.

Encontrará las direcciones de contacto en el sitio web de EIZO que se indica a continuación.

www.eizoglobal.com

Informazioni sul riciclaggio

Per lo smaltimento e il riciclaggio del presente prodotto, attenersi alle normative vigenti nel proprio paese per ridurre l'impatto ambientale. Per lo smaltimento, rivolgersi ad un distributore o un affiliato presenti nel proprio paese.

Gli indirizzi sono elencati nel sito Web EIZO riportato di seguito.

www.eizoglobal.com

Per informazioni sul riciclaggio per i clienti in Svizzera, consultare il sito Web riportato di seguito.

www.swico.ch

Återvinningsinformation

När denna produkt kasseras ska den hanteras och återvinnas enligt landets föreskrifter för att reducera miljöpåverkan. När du kasserar produkten ska du kontakta en distributör eller representant i ditt land.

Kontaktadresserna listas på EIZO-webbplatsen nedan.

www.eizoglobal.com

Πληροφορίες ανακύκλωσης

Το προϊόν αυτό, όταν απορρίπτεται, πρέπει να συλλέγεται και να ανακυκλώνεται σύμφωνα με τη νομοθεσία της χώρας σας έτσι ώστε να μην επιβαρύνει το περιβάλλον. Για να απορρίψετε το προϊόν, επικοινωνήστε με έναν αντιπρόσωπο ή μια θυγατρική εταιρεία στη χώρα σας.

Οι διευθύνσεις επικοινωνίας αναγράφονται στην τοποθεσία web της EIZO παρακάτω.

www.eizoglobal.com

Сведения по утилизации

По истечении срока службы данного продукта его следует принести на сборный пункт и утилизировать в соответствии с действующими предписаниями в вашей стране, чтобы уменьшить вредное воздействие на окружающую среду. Прежде чем выбросить данный продукт, обратитесь к дистрибьютору или в местное представительство компании в вашей стране.

Контактные адреса можно найти на веб-узле EIZO.

www.eizoglobal.com

Informatie over recycling

Wanneer u dit product wilt weggooien, moet het uit milieu-overwegingen worden verzameld en gerecycled volgens de betreffende wetgeving van uw land. Wanneer u dit product wilt weggooien, moet u contact opnemen met een distributeur of een partner in uw land.

De contactadressen worden vermeld op de volgende EIZO-website.

www.eizoglobal.com

Informação sobre reciclagem

Este produto, quando o deitar fora, deve ser recolhido e reciclado de acordo com a legislação do seu país para reduzir a poluição. Quando deitar fora este produto, contacte um distribuidor ou uma filial no seu país.

Os endereços de contacto estão listados no website do EIZO, abaixo.

www.eizoglobal.com

Oplysninger om genbrug

Denne produkt forventes ved bortskaffelse at blive indsamlet og genbrugt i overensstemmelse med lovgivningen i dit land for at reducere belastningen af miljøet. Når du bortskaffer denne produkt, skal du kontakte en distributør eller et tilknyttet selskab i dit land.

Adresserne på kontaktpersonerne er angivet på EIZO's websted nedenfor.

www.eizoglobal.com

Kierrätystä koskevia tietoja

Tuote tulee hävittää kierrättämällä maan lainsäädännön mukaisesti ympäristön kuormittumisen vähentämiseksi. Kun hävität tuotteen, ota yhteyttä jälleenmyyjään tai tytäryhtiöön maassasi.

Yhteystiedot löytyvät EIZOn Internet-sivustolta.

www.eizoglobal.com

Wykorzystanie surowców wtórnych

Ten produkt po zużyciu powinien być zbierany i przetwarzany zgodnie z krajowymi przepisami dotyczącymi ochrony środowiska. Wyrzucając ten produkt, należy skontaktować się z lokalnym dystrybutorem lub partnerem. Adresy kontaktowe można znaleźć we wskazanej poniżej witrynie internetowej firmy EIZO.

www.eizoglobal.com

Informace o recyklaci

Při likvidaci produktu musí být produkt vyzvednut a recyklován podle zákonů příslušné země, aby nedocházelo k zatěžování životního prostředí. Zbavujete-li se produktu, kontaktujte distributora nebo pobočku ve své zemi. Kontaktní adresy jsou uvedeny na následující webové stránce společnosti EIZO.

www.eizoglobal.com

Ringlussevõtu alane teave

Keskonnakoormuse vähendamiseks tuleks kasutatud tooted kokku koguda ja võtta ringlusse vastavalt teie riigi seadustele. Kui kõrvaldate käesoleva toote, võtke palun ühendust turustaja või filiaaliga oma riigis.

Kontaktisikud on toodud EIZO veebilehel järgmisel aadressil:

www.eizoglobal.com

Újrahasznosítási információ

Jelen terméket, amikor eldobjuk, az illető ország törvényei alapján kell összegyűjteni és újrahasznosítani, hogy csökkentjük a környezet terhelését. Amikor ezt a terméket eldobja, kérjük lépjen kapcsolatba egy országon belüli forgalmazóval vagy társvállalkozással.

A kapcsolat címei az EIZO alábbi weboldalán található felsorolva:

www.eizoglobal.com

Podatki o recikliranju

Ob koncu uporabe odslužen izdelek izročite na zbirno mesto za recikliranje v skladu z okoljevarstveno zakonodajo vaše države. Prosimo, da se pri odstranjevanju izdelka obrnete na lokalnega distributerja ali podružnico.

Kontaktni naslovi so objavljeni na spodaj navedenih spletnih straneh EIZO:

www.eizoglobal.com

Informácie o recyklácii

Pri likvidácii musí byť tento výrobok recyklovaný v súlade s legislatívou vašej krajiny, aby sa znížilo zaťaženie životného prostredia. Keď sa chcete zbaviť tohto výrobku, kontaktujte prosím distribútora alebo pobočku vo vašej krajine.

Zoznam kontaktných adries je uvedený na nasledovnej webovej stránke firmy EIZO:

www.eizoglobal.com

Pārstrādes informācija

Utilizējot šo produktu, tā savākšana un pārstrāde veicama atbilstoši jūsu valsts likumdošanas prasībām attiecībā uz slodzes uz vidi samazināšanu. Lai veiktu šī produkta utilizāciju, sazinieties ar izplatītāju vai pārstāvniecību jūsu valstī.

Kontaktadreses ir norādītas zemāk minētajā EIZO tīmekļa vietnē.

www.eizoglobal.com

Informacija apie gražinamąjį perdirbimą

Šalinant (išmetant) šiuos gaminius juos reikia surinkti ir perdirbti gražinamuoju būdu pagal jūsų šalies teisės aktus, siekiant sumažinti aplinkos teršimą. Kai reikia išmesti šį gaminį, kreipkitės į jūsų šalyje veikiančią gaminių pardavimo atstovybę arba jos filialą.

Kontaktiniai adresatai nurodyti EIZO interneto svetainėje.

www.eizoglobal.com

Информация относно рециклиране

При изхвърлянето на този продукт се предлага събирането и рециклирането му съобразно законите на вашата страна за да се намали замърсяването на околната среда. Когато искате да се освободите от този продукт, моля свържете се с търговския му представител или със съответните органи отговарящи за това във вашата страна.

Данните за връзка с нас са описани на следния Интернет сайт на EIZO:

www.eizoglobal.com

Informație referitoare la reciclare

Acest produs, când debarasat, trebuie colectat și reciclat conform legislației țării respective ca să reducem sarcina mediului. Când se debarasează de acest produs, vă rugăm să contactați un distribuitor sau un afiliat al țării respective.

Adresele de contact le găsiți pe pagina de web al EIZO:

www.eizoglobal.com

معلومات عن إعادة التدوير

عند التخلص من هذا المنتج، من الضروري تجميعه وإعادة تدويره وفقاً للقوانين المتبعة في بلدك لتقليل العبء المسلط على البيئة. عندما تتخلص من هذا المنتج، يرجى الاتصال بموزع أو طرف منتسب إليه في بلدك. عناوين الاتصال مدرجة في موقع ايزو EIZO ادناه على شبكة الانترنت.

www.eizoglobal.com

Geri Dönüşüm Bilgisi

Bu ürünün, atılacağı zaman, ülkenizin çevre kirliliğinin azaltılması konusundaki mevzuatına göre toplanması ve yeniden değerlendirilmesi gerekmektedir. Ürünü atacağınız zaman lütfen ülkenizdeki bir distribütör veya ilgili kuruluşla temasa geçiniz.

İrtibat adresleri aşağıdaki EIZO web sitesinde verilmiştir.

www.eizoglobal.com

