



User's Manual

DuraVision® FDF2121WT-A

Touch Panel Color LCD Monitor

Important

Please read this "User's Manual", and "Setup Manual" (separate volume) carefully to familiarize yourself with safe and effective usage.

-
- Refer to the "Setup Manual" for information on the installation / connection of the monitor.
 - For the latest product information including the "User's Manual", refer to our web site :
www.eizoglobal.com
-

This product has been adjusted specifically for use in the region to which it was originally shipped. If operated outside this region, the product may not perform as stated in the specifications.

No part of this manual may be reproduced, stored in a retrieval system, or transmitted, in any form or by any means, electronic, mechanical, or otherwise, without the prior written permission of EIZO Corporation. EIZO Corporation is under no obligation to hold any submitted material or information confidential unless prior arrangements are made pursuant to EIZO Corporation's receipt of said information. Although every effort has been made to ensure that this manual provides up-to-date information, please note that EIZO monitor specifications are subject to change without notice.

Notice for this monitor

This product is suited to general purposes like creating documents, viewing multimedia content.

This product has been adjusted specifically for use in the region to which it was originally shipped. If the product is used outside the region, it may not operate as specified in the specifications.

This product may not be covered by warranty for uses other than those described in this manual.

The specifications noted in this manual are only applicable when the following are used:

- Power cords provided with the product
 - Signal cables specified by us
-

Only use optional products manufactured or specified by us with this product.

If you place this product on a lacquer-coated desk, the color may adhere to the bottom of the stand due to the composition of the rubber. Check the desk surface before use.

It takes about 30 minutes (under our measurement conditions) for the monitor display to stabilize. Please wait 30 minutes or more after the monitor power has been turned on, and then adjust the monitor.

Monitors should be set to a lower brightness to reduce changes in luminosity caused by long-term use and maintain a stable display.

When the screen image is changed after displaying the same image for extended periods of time, an afterimage may appear. Use the screen saver or power save function to avoid displaying the same image for extended periods of time. Depending on the image, an afterimage may appear even if it was displayed for a short period of time. To remove such a phenomenon, change the image or keep the power turned off for several hours.

If the monitor displays continuously over a long period of time, dark smudges or burn-in may appear. To maximize the life of the monitor, we recommend the monitor be turned off periodically.

Periodic cleaning is recommended to keep the monitor looking new and to prolong its operation lifetime (refer to [“Cleaning” \(page 4\)](#)).

The LCD panel is manufactured using high-precision technology. Although, missing pixels or lit pixels may appear on the LCD panel, this is not a malfunction. Percentage of effective dots: 99.9994 % or higher.

The backlight of the LCD panel has a fixed lifetime. Depending on the usage pattern, such as usage for long continuous periods, the lifespan of the backlight may run out sooner, requiring replacement. When the screen becomes dark or begins to flicker, please contact your local EIZO representative.

Do not scratch or press on the LCD panel with any sharp objects, at this may result in damage to the LCD panel. Do not attempt to brush with tissues as this may scratch the panel.

When the monitor is cold and brought into a room or the room temperature goes up quickly, dew condensation may occur on the interior and exterior surfaces of the monitor. In that case, do not turn the monitor on. Instead wait until the dew condensation disappears, otherwise it may cause some damage to the monitor.

(Cautions for the Use of the Touch Panel)

- During touch operation
 - Be careful of the following points. Otherwise, damage to the monitor or malfunctions may occur.
 - Do not strongly press, scratch, or poke the panel.
 - Do not touch the panel with hard objects such as ballpoint pens or metals.
 - Do not touch the black periphery of the screen.
 - Do not stick tape or anything else onto the panel or the black periphery of the panel.
 - If any liquid comes into contact with the panel, wipe it off immediately.
 - Do not allow liquid to enter between the panel and the panel frame.
-
-

Cleaning

The stains on the cabinet and LCD panel surface can be removed by moistening part of a soft cloth with water.

Attention

- Do not allow liquid to enter the clearance between the panel and the panel frame.
- Chemicals such as alcohol and antiseptic solution may cause gloss variation, tarnishing, and fading of the cabinet or LCD panel, and also quality deterioration of the image.
- Never use thinner, benzine, wax, or abrasive cleaner as they may damage the cabinet or LCD panel surface.

Note

- It is recommended that ScreenCleaner (available as an option) be used to clean the cabinet and LCD panel surface.
-

To use the monitor comfortably

- An excessively dark or bright screen may affect your eyes. Adjust the brightness of the monitor according to the environmental conditions.
- Staring at the monitor for a long time tires your eyes. Take a 10-minute rest every hour.

CONTENTS

Notice for this monitor	3	3-8. Resetting the Monitor to the Default Settings	22
Cleaning	4	● To reset the color adjustments	22
To use the monitor comfortably	4	● To reset all adjustments to the default settings	22
CONTENTS	5	Chapter 4 Touch Panel Settings	23
Chapter 1 Introduction	6	4-1. Calibrating the Monitor	23
1-1. Features	6	4-2. Configuring Touch Panel Operation Settings	25
1-2. EIZO LCD Utility Disk	6	Chapter 5 Power Saving Functions	26
● Disk contents and software overview	6	5-1. Setting Power Saving	26
1-3. Basic Operations and Functions	7	● Monitor	26
● Basic operation of the Setting menu	7	● Audio Output	27
● Functions	8	5-2. Setting Power Indicator	27
Chapter 2 Adjusting Screens	9	5-3. Enabling / Disabling Auto Power-OFF	27
2-1. Setting the Resolution	9	Chapter 6 Troubleshooting	28
● Windows 10	9	6-1. No picture	28
● Windows 8.1 / Windows 7	9	6-2. Imaging problems (for both digital and analog)	29
2-2. Adjusting Color	10	6-3. Imaging problems (for analog only)	30
● To select the display mode (FineContrast Mode)	10	6-4. Touch panel problems	31
● To perform advanced adjustments	11	6-5. Other problems	32
● Adjustable settings in each mode	11	Chapter 7 Reference	33
● To adjust brightness	11	7-1. Attaching the Optional Arm	33
● To adjust contrast	12	7-2. Connecting Multiple PCs	35
● To adjust color temperature	12	● To switch among input signals	35
● To adjust gamma	13	● To set input signal selection	36
● To adjust the color saturation	13	7-3. Displaying Monitor Information	36
● To adjust hue	13	7-4. Preset Timing	37
● To adjust gain	14	Chapter 8 Glossary	38
2-3. Screen Adjustment	15	Appendix	40
● Digital Signal Input	15	Trademark	40
● Analog Signal Input	15	License / Copyright	40
2-4. Screen Size Changing	19	FCC Declaration of Conformity	41
● Screen Size Changing	19	LIMITED WARRANTY	42
● To adjust brightness of non-display area	19	Recycling Information	52
Chapter 3 Setting Monitor	20	China Measures for RoHS Compliance in ChinaRoHS	56
3-1. Adjusting Volume	20		
3-2. Selecting sound source while using the DisplayPort signal input	20		
3-3. Enabling / Disabling DDC/CI communication	20		
3-4. Locking Operation Buttons	21		
3-5. Showing and hiding the EIZO logo	21		
3-6. Changing Setting Menu Display Position	21		
3-7. Setting Language	21		

Chapter 1 Introduction

Thank you very much for choosing an EIZO color LCD monitor.

1-1. Features

- 21.5" wide format LCD
- Supports a resolution of 1920 × 1080
- Touch Panel provided
 - Surface Acoustic Wave technology
 - Supported OS: Microsoft Windows 10 / Windows 8.1 / Windows 7
 - Supports the Windows Touch function (multi-touch) of Microsoft Windows 10 / Windows 8.1 / Windows 7.*1
- *1 This product supports up to two simultaneous touches (multi-touch support).
- 3 signal input terminals (DVI-D × 1, DisplayPort × 1, D-Sub × 1)
 - Applicable to DisplayPort (applicable to 8 bit)*2
 - The DisplayPort input receives both an image signal and an audio signal via a single DisplayPort cable.
- *2 When transmitting an audio signal using the DisplayPort cable, the graphics board must be compatible with audio output (see "Specifications" in the Setup Manual).
- The FineContrast function allows the user to select the display mode optimum to the displayed image.
- Flattening of the bezel allows smooth touch operations.
- Small footprint achieved through low-profile and lightweight design
The monitor can be readily moved and its position adjusted.
- Power saving function
Suppressing the power consumption reduces the carbon dioxide emissions. This product is equipped with power saving function.
 - 0 W power consumption when the main power is off
 - Equipped with main power switch.
 - When the monitor is not required, the power supply can be shut off using the main power switch.
- Displays HDCP (High-bandwidth Digital Protection) protected contents.

1-2. EIZO LCD Utility Disk

An "EIZO LCD Utility Disk" (CD-ROM) is supplied with this product. The following table shows the disk contents and the overview of the software programs.

● Disk contents and software overview

The disk includes software programs for adjustment, and User's Manual. Refer to Readme.txt file on the disk for software startup procedures or file access procedures.

Item	Overview
Screen adjustment pattern files	Used when adjusting the image of analog signal input manually.
User's Manual of this monitor (PDF file)	
Readme.txt file	

1-3. Basic Operations and Functions

● Basic operation of the Setting menu

1. Displaying the Setting menu

1. Press ENTER. The Setting menu appears.



2. Adjusting / Setting

1. Choose a menu to adjust / set with ▲,▼, and then press ENTER. The Sub menu appears.

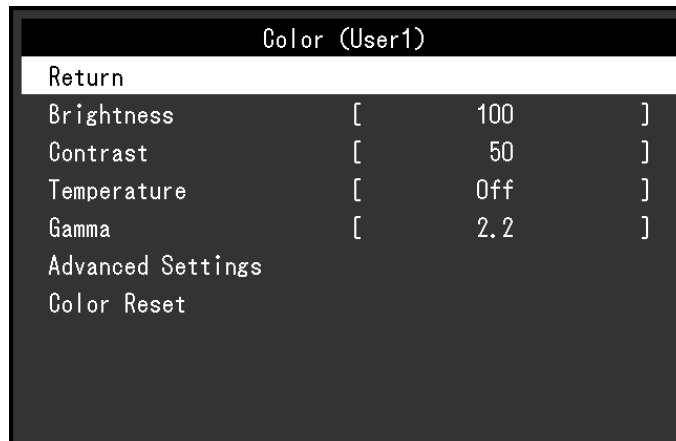

2. Choose an item to adjust / set with ▲,▼, and then press ENTER. The adjustment / setting menu appears.



3. Adjust / set the selected item with ▲,▼, and then press ENTER.

3. Exiting

1. Choose "Return" from the Sub menu and press ENTER. The Setting menu appears.
2. Choose "Exit" from the Main menu and press ENTER. The Setting menu quits.

Note

- The Setting menu can also be exited by pressing ENTER twice quickly.
-

● Functions

The following table shows the Setting menu and setting items of each menu.

Main menu	Setting	Reference	
Color ^{*1}	Brightness	"2-2. Adjusting Color" (page 10)	
	Contrast		
	Temperature		
	Gamma		
	Advanced Settings		Saturation
		Hue	
	Gain		
	Color Reset	"To reset the color adjustments" (page 22)	
Screen	Screen Size	"Screen Size Changing" (page 19)	
	Smoothing	"2-3. Screen Adjustment" (page 15)	
	Analog Adjustment ^{*2}		Auto Screen Adjust
			Auto Range Adjust
			Clock
			Phase
			Hor.Position
Ver.Position			
Sound	Source	"3-2. Selecting sound source while using the DisplayPort signal input" (page 20)	
	Power Save	"Audio Output" (page 27)	
PowerManager	Power Save	"5-1. Setting Power Saving" (page 26)	
	Eco Timer	"5-3. Enabling / Disabling Auto Power-OFF" (page 27)	
Monitor Settings	Input Signal	"To set input signal selection" (page 36)	
	Power Indicator	"5-2. Setting Power Indicator" (page 27)	
	Language	"3-7. Setting Language" (page 21)	
	DDC/CI	"3-3. Enabling / Disabling DDC/CI communication" (page 20)	
	Border Intensity	"To adjust brightness of non-display area" (page 19)	
	Menu Settings	Logo	"3-5. Showing and hiding the EIZO logo" (page 21)
		Menu Position	"3-6. Changing Setting Menu Display Position" (page 21)
	Reset	"To reset all adjustments to the default settings" (page 22)	
Information		"7-3. Displaying Monitor Information" (page 36)	

*1 The adjustment / settings available on the "Color" menu depend on the selected Color mode. ("Adjustable settings in each mode" (page 11))

*2 These functions can be adjusted with analog input.

Chapter 2 Adjusting Screens

2-1. Setting the Resolution

When you connect the monitor to the PC and find that the resolution is improper, or when you want to change the resolution, follow the procedure below.

● Windows 10

1. Right-click the mouse anywhere on the desktop except for icons.
2. From the displayed menu, click “Display Settings”.
3. On the “Customize your display” dialog box, click “Advanced display settings”.
4. Select a monitor, then choose a resolution from the “Resolution” pull-down menu.
5. Click the “Apply” button.
6. When a confirmation dialog box is displayed, click “Keep changes”.

● Windows 8.1 / Windows 7

1. For Windows 8.1, click the “Desktop” tile on the Start Screen to display the desktop.
2. Right-click the mouse anywhere on the desktop except for icons.
3. From the displayed menu, click “Screen resolution”.
4. On the “Screen Resolution” dialog box, select the monitor.
5. Click “Resolution” to select the desired resolution.
6. Click the “OK” button.
7. When a confirmation dialog box is displayed, click “Keep changes”.

2-2. Adjusting Color

● To select the display mode (FineContrast Mode)

This function allows easy selection of a desired mode according to monitor application.

Display Modes

Mode	Purpose
User1	Select this to define a desired set of parameter settings.
User2	
sRGB	Suitable for color matching with sRGB compatible peripherals.

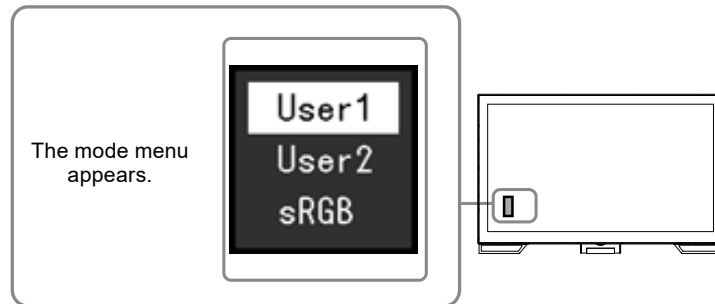

Procedure

1. Press MODE.

The mode menu appears at the bottom left of the screen.

2. The mode among the list is highlighted in turn each time MODE is pressed.

You can switch the mode with ▲ or ▼ while the mode menu is displayed.



Note

- The Setting menu and the Mode menu cannot be displayed at the same time.

● To perform advanced adjustments

The “Color” menu of the Setting menu allows you to set and save the independent color adjustment for each mode.

Attention

- It takes about 30 minutes for the performance of electrical parts to stabilize. Please wait 30 minutes or more after the monitor power has been turned on, and then adjust the monitor.
- Perform the range adjustment first when adjusting color for analog signals (see “To adjust color gradation automatically” (page 18)).
- The same image may be seen in different colors on multiple monitors due to their monitor-specific characteristics. Make fine color adjustment visually when matching colors on multiple monitors.

● Adjustable settings in each mode

The adjustable settings depend on the mode. (Non-adjustable or non-settable function cannot be selected.)

√: Adjustable -: Not adjustable

Function		FineContrast Mode		
		User1	User2	sRGB
Brightness		√	√	√
Contrast		√	√	-
Temperature		√	√	-
Gamma		√	√	-
Advanced Settings	Saturation	√	√	-
	Hue	√	√	-
	Gain	√	√	-
Color Reset		√	√	√

● To adjust brightness

The screen brightness is adjusted by changing the brightness of the backlight (light source from the LCD back panel).

Adjustable range

0 to 100

Procedure

1. Press ▲/☼.
2. Use ▲ or ▼ for adjustment.
3. Press ENTER to exit.

Note

- If you feel that the image is too dark even if the brightness is set to 100, adjust the contrast.
- Alternatively, you can use “Brightness” under “Color” in the Adjustment menu to adjust it.

● To adjust contrast

The brightness of the screen is adjusted by varying the video signal level.

Adjustable range

0 to 100

Procedure

1. Choose “Color” in the Setting menu, and press ENTER.
2. Choose “Contrast” in the “Color” menu, and press ENTER.
The “Contrast” menu appears.
3. Use ▲ or ▼ for adjustment.
4. Press ENTER to exit.

Note

- In the contrast of 50, every color gradation is displayed.
 - When adjusting the monitor, it is recommended to perform the brightness adjustment which may not lose the gradation characteristics, prior to the contrast adjustment.
 - Perform the contrast adjustment in the following cases.
 - When you feel the image is too dark even if the brightness is set to 100 (Set the contrast to higher than 50.)
-

● To adjust color temperature

Color temperature can be adjusted.

The color temperature is normally used to express the hue of “White” and / or “Black” by a numerical value. The value is expressed in degrees “K” (Kelvin).

The screen becomes reddish at a low color temperature, and bluish at a high color temperature, like the flame temperature. A gain preset value is set for each color temperature setting value.

Adjustable range

Off, 4000 K-10000 K (specified by every 500 K unit, including 9300 K)

Procedure

1. Choose “Color” in the Setting menu, and press ENTER.
2. Choose “Temperature” in the “Color” menu, and press ENTER.
The “Temperature” menu appears.
3. Use ▲ or ▼ for adjustment.
4. Press ENTER to exit.

Note

- The value shown in “K” is available only as reference.
 - “Gain” allows you to perform more advanced adjustment (see [“To adjust gain” \(page 14\)](#)).
 - If you set to “Off”, the image is displayed in the preset color of the monitor (Gain: 100 for each RGB).
 - When gain is changed, the color temperature is changed to “Off”.
-

● To adjust gamma

Gamma can be adjusted. The brightness of the monitor varies depending on the input signal, however, the variation rate is not proportional to the input signal. To keep the balance between the input signal and the brightness of the monitor is called as “Gamma correction”.

Adjustable range

1.8, 2.0, 2.2

Procedure

1. Choose “Color” in the Setting menu, and press ENTER.
2. Choose “Gamma” in the “Color” menu, and press ENTER.
The “Gamma” menu appears.
3. Use ▲ or ▼ for adjustment.
4. Press ENTER to exit.

● To adjust the color saturation

This function allows you to adjust color saturation.

Adjustable range

-50 to 50

Procedure

1. Choose “Color” in the Setting menu, and press ENTER.
2. Choose “Advanced Settings” in the “Color” menu, and press ENTER.
3. Choose “Saturation” in the “Advanced Settings” menu, and press ENTER.
The “Saturation” menu appears.
4. Use ▲ or ▼ for adjustment.
5. Press ENTER to exit.

Attention

- Using this function may make some color gradations unavailable for display.

Note

- The minimum value (-50) changes the screen to monochrome.
-

● To adjust hue

This function allows you to adjust hue.

Adjustable range

-50 to 50

Procedure

1. Choose “Color” in the Setting menu, and press ENTER.
2. Choose “Advanced Settings” in the “Color” menu, and press ENTER.
3. Choose “Hue” in the “Advanced Settings” menu, and press ENTER.
The “Hue” menu appears.
4. Use ▲ or ▼ for adjustment.
5. Press ENTER to exit.

Attention

- Using this function may make some color gradations unavailable for display.
-

● To adjust gain

The brightness of each color component red, green, and blue is called “Gain”. You can change the hue of “white” by adjusting gain.

Adjustable range

0 to 100

Procedure

1. Choose “Color” in the Setting menu, and press ENTER.
2. Choose “Advanced Settings” in the “Color” menu, and press ENTER.
3. Choose “Gain” in the “Advanced Settings” menu, and press ENTER.

The “Gain” menu appears.

4. Adjust gain with ▲ or ▼ for each of red, green, and blue.
5. Press ENTER to exit.

Attention

- Using this function may make some color gradations unavailable for display.

Note

- The value of gain changes with that of color temperature.
 - When gain is changed, the color temperature is changed to “Off”.
-

2-3. Screen Adjustment

● Digital Signal Input

When digital signals are input, images are displayed correctly based on the preset data of the monitor, but if characters and / or lines appear blurred, go to [“To modify blurred characters / lines” \(page 18\)](#).

When performing more advanced adjustment, see [“2-2. Adjusting Color” \(page 10\)](#) and subsequent pages.

● Analog Signal Input

Attention

- It takes about 30 minutes for the performance of electrical parts to stabilize. Please wait 30 minutes or more after the monitor power has been turned on, and then adjust the monitor.
 - The Self Adjust (automatic screen adjustment) function does not work for the images under the resolution of 800 × 600 (SVGA).
 - The self adjustment (or automatic screen adjustment) function works correctly when an image is fully displayed over the Windows or Macintosh display area. They do not work properly in the cases below:
 - When an image is displayed only on a part of the screen (command prompt window, for example)
 - When a black background (wallpaper, etc.) is in use
- Also, these functions cannot work properly in some graphic boards.
-

The monitor screen adjustment is used to suppress flickering of the screen or adjust screen position and screen size correctly according to the PC to be used.

Note

- The Self Adjust function works when all of the following conditions are satisfied:
 - When a signal is input into the monitor for the first time or when a resolution or vertical / horizontal scan frequency not used before is set
-

If the screen is not displayed correctly even after performing the Self Adjust operation, adjust the screen according to the procedures on the following pages to use the monitor comfortably.

Setting Procedures

1. Perform the auto adjustment.

● To adjust flickering, screen position, and screen size automatically

Procedure

1. Choose “Screen” in the Setting menu, and press ENTER.
2. Choose “Analog Adjustment” in the “Screen” menu, and press ENTER.
3. Choose “Auto Screen Adjust” in the “Analog Adjustment” menu, and press ENTER.
4. Select “Yes” with ▲ or ▼, and press ENTER.

Flickering, screen position, and screen size are corrected by the auto-adjustment function.

If the screen is not displayed correctly even after performing the auto adjustment, perform adjustments according to the following procedure. If the screen is displayed correctly, go to [“5. Adjusting color gradation.” \(page 18\)](#).

2. Prepare to use analog screen adjustment patterns.

Load the “EIZO LCD Utility Disk” to your PC, and then open the “Screen adjustment pattern files”.

Note

- For details and instructions on opening the “Screen adjustment pattern files”, refer to the Readme.txt file.

3. Perform the auto adjustment again with the analog screen adjustment pattern displayed.

● To adjust flickering, screen position, and screen size automatically

Procedure

1. Display Pattern 1 in full screen on the monitor using the “Screen adjustment pattern files”.

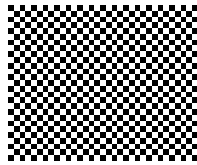

2. Choose “Screen” in the Setting menu, and press ENTER.
3. Choose “Analog Adjustment” in the “Screen” menu, and press ENTER.
4. Choose “Auto Screen Adjust” in the “Analog Adjustment” menu, and press ENTER.
5. Select “Yes” with ▲ or ▼, and press ENTER.

Flickering, screen position, and screen size are corrected by the auto-adjustment function.

If the screen is not displayed correctly even after performing the auto adjustment, perform adjustments according to the following procedure. If the screen is displayed correctly, go to [“5. Adjusting color gradation.”](#) (page 18).

4. Choose “Screen” from the Setting menu to perform advanced adjustments.

Adjust the clock, phase and position, in this order.

● To eliminate vertical bars

Procedure

1. Choose “Analog Adjustment” in the “Screen” menu, and press ENTER.
2. Choose “Clock” in the “Analog Adjustment” menu, and press ENTER.

The “Clock” menu appears.

3. Adjust the clock with ▲ or ▼ to eliminate vertical bars.
Press ▲ or ▼ slowly so as not to miss the adjustment point.
4. Press ENTER to exit.

When blurring, flickering or bars appear on the screen after adjustment, proceed to “To remove flickering or blurring”.

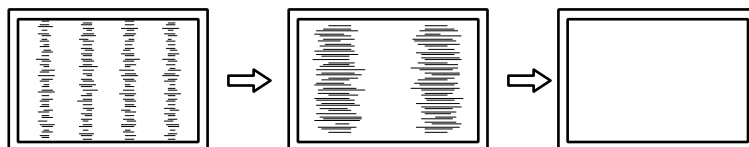

● To remove flickering or blurring

Procedure

1. Choose “Analog Adjustment” in the “Screen” menu, and press ENTER.
2. Choose “Phase” in the “Analog Adjustment” menu, and press ENTER.

The “Phase” menu appears.

3. Adjust the phase with ▲ or ▼ to minimize flickering or blurring.
4. Press ENTER to exit.

When vertical bars appear on the screen after adjustment, go back to “To eliminate vertical bars”.

(Clock → Phase → Position)

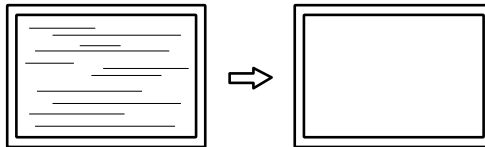

Attention

- Flickering or blurring may not be eliminated depending on your PC or graphics board.
-

● To correct the screen position

Note

- Since the number of pixels and the pixel positions are fixed on the LCD monitor, only one position is provided to display images correctly. The position adjustment is made to shift an image to the correct position.
-

Procedure

1. Choose “Analog Adjustment” in the “Screen” menu, and press ENTER.
2. Choose “Hor.Position” or “Ver.Position” from the “Analog Adjustment” menu, and press ENTER.

The “Hor. Position” or “Ver. Position” menu appears.

3. Adjust the position with ▲ or ▼.
4. Press ENTER to exit.

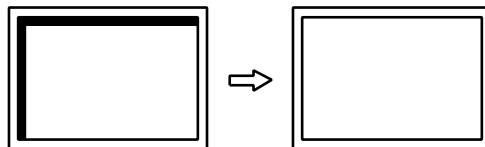

5. Close Pattern 1.

5. Adjusting color gradation.

● To adjust color gradation automatically

Every color gradation (0 to 255) can be displayed by adjusting the signal output level.

Procedure

1. Display Pattern 2 in full screen on the monitor using the “Screen adjustment pattern files”.

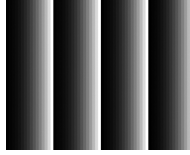

2. Choose “Screen” in the Setting menu, and press ENTER.
3. Choose “Analog Adjustment” in the “Screen” menu, and press ENTER.
4. Choose “Auto Range Adjust” in the “Analog Adjustment” menu, and press ENTER.
5. Select “Yes” with ▲ or ▼, and press ENTER.
The output range is set automatically.
6. Close Pattern 2.

6. Modify blurred characters or lines.

● To modify blurred characters / lines

When an image is displayed with a resolution other than recommended, the characters or lines of the displayed image may blur.

Attention

- Smoothing setting may not be required depending on the display resolution. (You cannot choose the smoothing icon.)
-

Adjustable range

1 to 5

Procedure

1. Choose “Screen” in the Setting menu, and press ENTER.
2. Choose “Smoothing” in the “Screen” menu, and press ENTER.
The “Smoothing” menu appears.
3. Use ▲ or ▼ for adjustment.
4. Press ENTER to exit.

2-4. Screen Size Changing

● Screen Size Changing

The image with the resolution other than the recommended resolution is displayed in full screen automatically. You can change the screen size by using the “Screen Size” function.

Setting	Function
Full Screen	Displays an image in full screen. Images are distorted in some cases because the vertical rate is not equal to the horizontal rate.
Enlarged	Displays an image in full screen. In some cases, a blank horizontal or vertical border appears to equalize the vertical rate and the horizontal rate.
Normal	Displays images with the specified resolution.

Example: Image size 1024 × 768

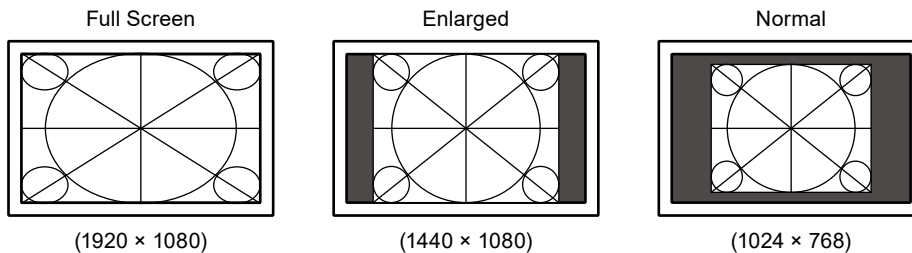

Procedure

1. Choose “Screen” in the Setting menu, and press ENTER.
2. Choose “Screen Size” in the “Screen” menu, and press ENTER.
The “Screen Size” menu appears.
3. Select “Full Screen”, “Enlarged”, or “Normal” with ▲ or ▼.
4. Press ENTER to exit.

Attention

- Selecting “Normal” may make some color gradations unavailable for display.

● To adjust brightness of non-display area

A border (black area with no image) around the image appears in the “Normal” or “Enlarged” mode.

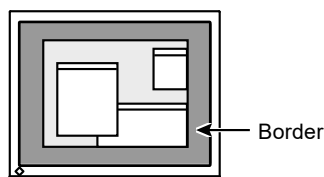

Procedure

1. Choose “Monitor Settings” in the Setting menu, and press ENTER.
2. Choose “Border Intensity” in the “Monitor Settings” menu, and press ENTER.
The “Border Intensity” menu appears.
3. Use ▲ or ▼ for adjustment.
4. Press ENTER to exit.

Chapter 3 Setting Monitor

3-1. Adjusting Volume

This function allows you to adjust the speaker volume.

Adjustable range

0 to 30

Procedure

1. Press ▼ / (M).
2. Use ▲ or ▼ for adjustment.
3. Press ENTER to exit.

3-2. Selecting sound source while using the DisplayPort signal input

This function allows you to switch sound source during DisplayPort signal input. You can select the Stereo Mini Jack or DisplayPort.

Procedure

1. Choose "Sound" in the Setting menu, and press ENTER.
2. Choose "Source" in the "Sound" menu, and press ENTER.
The "Source" menu appears.
3. Select "Stereo Mini Jack" or "DisplayPort" with ▲ or ▼.
4. Press ENTER to exit.

Note

- This function is available with DisplayPort signal input.
-

3-3. Enabling / Disabling DDC/CI communication

This function allows you to enable / disable the DDC/CI communication (see "[Chapter 8 Glossary](#)" (page 38)).

Procedure

1. Choose "Monitor Settings" in the Setting menu, and press ENTER.
2. Choose "DDC/CI" in the "Monitor Settings" menu, and press ENTER.
The "DDC/CI" menu appears.
3. Select "On" or "Off" with ▲ or ▼.
4. Press ENTER to exit.

Note

- The DisplayPort input of this monitor does not support DDC/CI communication.
-

3-4. Locking Operation Buttons

This function allows you to lock the settings to prevent them being changed.

Procedure

1. Press \odot to turn off the monitor.
2. Hold down SIGNAL while pressing \odot to turn on the monitor.
The Lock / Unlock setting is toggled by performing the operation in step 2.

Note

- The following operations are available even if the buttons are locked.
 - Turning on or off the monitor with the Power button
-

3-5. Showing and hiding the EIZO logo

When the monitor is turned on, the EIZO logo appears on the screen. You can choose to show or hide the display of the EIZO logo.

Procedure

1. Choose "Monitor Settings" in the Setting menu, and press ENTER .
2. Choose "Menu Settings" in the "Monitor Settings" menu, and press ENTER.
3. Choose "Logo" in the "Menu Settings" menu, and press ENTER.
The "Logo" menu appears.
4. Select "On" or "Off" with \blacktriangle or \blacktriangledown .
5. Press ENTER to exit.

3-6. Changing Setting Menu Display Position

You can change the display position of the Setting menu.

Procedure

1. Choose "Monitor Settings" in the Setting menu, and press ENTER .
2. Choose "Menu Settings" in the "Monitor Settings" menu, and press ENTER.
3. Choose "Menu Position" in the "Menu Settings" menu, and press ENTER.
The "Menu Position" menu appears.
4. Choose the position with \blacktriangle or \blacktriangledown .
5. Press ENTER to exit.

3-7. Setting Language

This function allows you to select a language for the Setting menu or messages.

Selectable languages

English, German, French, Spanish, Italian, Swedish, Japanese, Simplified Chinese, Traditional Chinese

Procedure

1. Choose "Monitor Settings" in the Setting menu, and press ENTER.
2. Choose "Language" in the "Monitor Settings" menu, and press ENTER.
The "Language" menu appears.
3. Choose a language with \blacktriangle or \blacktriangledown .
4. Press ENTER to exit.

3-8. Resetting the Monitor to the Default Settings

The setting values are reset to the default settings.

Attention

- After resetting, you cannot undo the operation.

Note

- Regarding the default setting, see “Main Default Settings” in the Setup Manual.
-

● To reset the color adjustments

This function only resets the color adjustments for the currently selected mode to the default settings.

Procedure

1. Choose “Color” in the Setting menu, and press ENTER.
2. Choose “Color Reset” in the “Color” menu, and press ENTER.
3. Select “Yes” with ▲ or ▼.
4. Press ENTER.

The color adjustments revert to the default settings.

● To reset all adjustments to the default settings

This function resets all adjustments to the default settings.

Procedure

1. Choose “Monitor Settings” in the Setting menu, and press ENTER.
2. Choose “Reset” in the “Monitor Settings” menu, and press ENTER.
3. Select “Yes” with ▲ or ▼.
4. Press ENTER.

All adjustments revert to the default settings.

Chapter 4 Touch Panel Settings

Settings are configured on the Windows Control Panel.

4-1. Calibrating the Monitor

Attention

- If a “User Account Control” dialog box is displayed during operation, proceed according to the displayed instructions.
-

1. Open the Windows Control Panel.

The method for opening the Control Panel differs depending on the OS.

Windows 10

1. Open the Start menu, and click “All apps” - “Windows System” - “Control Panel”.

Windows 8.1

1. Click  at the bottom of the “Start” screen.
The “Apps” screen appears.
2. Click “Control Panel” under “Windows System”.

Windows 7

1. Click “Start” - “Control Panel”.

2. Click “Hardware and Sound” - “Tablet PC Settings”.

The “Tablet PC Settings” window appears.

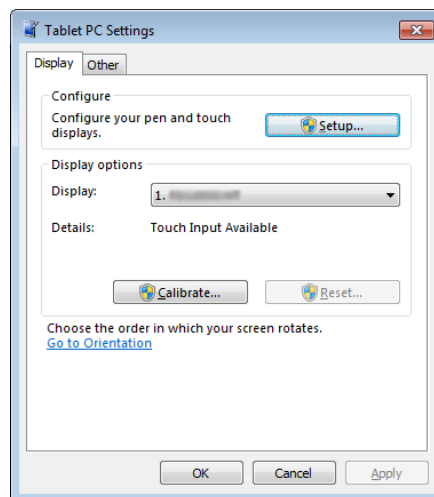

3. Click “Setup” in the “Display” tab.

A touchscreen specification screen with a white background is displayed.

Attention

- If using the monitor in a multiple monitor environment, specify the touchscreen according to the message displayed on screen.
-

4. Touch the screen with your finger.

The touched screen is recognized as a touchscreen.

5. Press “Enter” on the keyboard.

The “Tablet PC Settings” window reappears.

6. Click “Calibrate”.

A calibration screen with a white background is displayed.

Attention

- If using the monitor in a multiple monitor environment, select the monitor for calibration from the “Display” pulldown menu and then click “Calibrate”.
-

7. Touch the calibration target (cross) for a few seconds with your finger and release.

The calibration target appears on the screen 16 times, starting from the top left to top right and then down to the bottom left to bottom right.

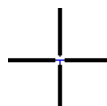

Note

- For second or subsequent calibrations, the calibration target appears 4 times.
-

8. After completing calibration, click “Yes” to save the calibration data.

9. Click “OK” to close the window.

4-2. Configuring Touch Panel Operation Settings

1. Open the Windows Control Panel.

The method for opening the Control Panel differs depending on the OS (see [page 23](#)).

2. Click “Hardware and Sound” - “Pen and Touch”.

“Pen and Touch” window appears.

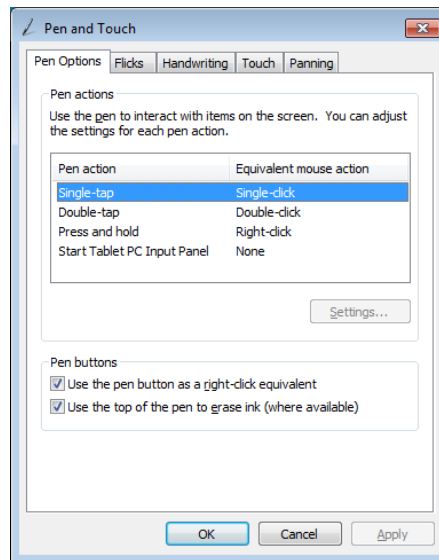

Configure the touch panel operation settings in the “Pen and Touch” window. For detailed settings, refer to the settings on each tab and Windows Help.

3. After completing settings, click “OK” to close the window.

Chapter 5 Power Saving Functions

5-1. Setting Power Saving

● Monitor

This function allows you to set the monitor into the power saving mode according to the PC status. When the monitor has shifted to the power saving mode, the images on the screen are not displayed.

Attention

- Turning off the main power switch or unplugging the power cord completely shuts off power supply to the monitor.
- Power consumption varies even when the stereo mini jack cable is connected.

Note

- The monitor changes to the power saving mode about 15 seconds after the signal input ceases to be detected.

Procedure

1. Choose "PowerManager" in the Setting menu, and press ENTER.
2. Choose "Power Save" in the "PowerManager" menu, and press ENTER.
The "Power Save" menu appears.
3. Select "On" or "Off" with ▲ or ▼.
4. Press ENTER to exit.

Power Saving System

Analog Signal Input

This monitor complies with the VESA DPM standard.

PC		Monitor	Power Indicator
On		Operating	Blue
Power saving mode	STAND-BY SUSPENDED OFF	Power saving mode	Orange
Power Off		Power saving mode	Orange

Digital Signal Input

- DVI

This monitor complies with the DVI DMPM standard.

PC		Monitor	Power Indicator
On		Operating	Blue
Power saving mode		Power saving mode	Orange
Power Off		Power saving mode	Orange

Exiting the power saving mode

If the monitor receives input, it automatically exits the power saving mode and returns to the normal display mode.

● Audio Output

This monitor allows you to turn on/off audio output from the speakers in the power saving mode.

Procedure

1. Choose "Sound" in the Setting menu, and press ENTER.
2. Choose "Power Save" in the "Sound" menu, and press ENTER.
The "Power Save" menu appears.
3. Select "Sound On" or "Sound Off" with ▲ or ▼.
4. Press ENTER to exit.

5-2. Setting Power Indicator

This function allows you to set the power indicator (blue) ON / OFF in the monitor ON condition.

Procedure

1. Choose "Monitor Settings" in the Setting menu, and press ENTER.
2. Choose "Power Indicator" in the "Monitor Settings" menu, and press ENTER.
The "Power Indicator" menu appears.
3. Select "On" or "Off" with ▲ or ▼.
4. Press ENTER to exit.

5-3. Enabling / Disabling Auto Power-OFF

This function allows you to switch the setting to turn off the monitor automatically after a specified time has passed in the power saving mode.

Adjustable range



Off, 0, 1, 2, 3, 5, 10, 15, 20, 25, 30, 45 min, 1, 2, 3, 4, 5 h

Procedure

1. Choose "PowerManager" in the Setting menu, and press ENTER.
2. Choose "Eco Timer" in the "PowerManager", and press ENTER.
3. Select "Off" or time to turn off the monitor with ▲ or ▼.
4. Press ENTER to exit.

Chapter 6 Troubleshooting

6-1. No picture

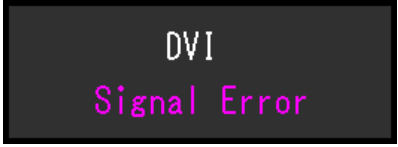

Problem	Possible cause and remedy
<p>1. No picture</p> <ul style="list-style-type: none"> Power indicator does not light. 	<ul style="list-style-type: none"> Check whether the power cord is connected properly. Turn the main power switch on. Press . Turn off the main power, and then turn it on again a few minutes later.
<ul style="list-style-type: none"> Power indicator is lighting blue. 	<ul style="list-style-type: none"> Increase “Brightness”, “Contrast”, or “Gain” in the Setting menu (see “To perform advanced adjustments” (page 11)).
<ul style="list-style-type: none"> Power indicator is lighting orange. 	<ul style="list-style-type: none"> Switch the input signal with SIGNAL. Move the mouse or press any key on the keyboard. Touch the panel surface. Check whether the PC is turned on. Depending on the PC and graphics board, the input signal is not detected and the monitor does not recover from the power saving mode. If the screen is not displayed even after moving the mouse or pressing any key on the keyboard, turn the monitor off and on using its power button. When the screen is displayed, execute the following procedure. The problem may be improved. <ol style="list-style-type: none"> Press  to turn off the monitor. Hold down MODE while pressing  to turn on the monitor. “x” is displayed on the menu title of “Information” of the Setting menu (see “7-3. Displaying Monitor Information” (page 36)). Reboot the PC. To return to the previous setting, perform steps 1 to 3 again. <div data-bbox="884 1364 1310 1644" data-label="Image"> </div>
<ul style="list-style-type: none"> Power indicator is flashing orange. 	<ul style="list-style-type: none"> The device that is connected using DisplayPort have a problem. Solve the problem, turn off the monitor, and then turn it on again. Refer to the User’s Manual of the output device for further details.

Problem	Possible cause and remedy
<p>2. The message below appears.</p> <ul style="list-style-type: none"> The message shows that the input signal is out of the specified frequency range. Example: 	<p>This message appears when the signal is not input correctly even when the monitor functions properly.</p> <ul style="list-style-type: none"> Check whether the PC is configured to meet the resolution and vertical scan frequency requirements of the monitor (see “Compatible Resolutions” in the Setup Manual). Reboot the PC. Select an appropriate setting using the graphics board’s utility. Refer to the User’s Manual of the graphics board for details.

6-2. Imaging problems (for both digital and analog)

Problem	Possible cause and remedy
<p>1. The screen is too bright or too dark.</p>	<ul style="list-style-type: none"> Use “Brightness” or “Contrast” in the Setting menu to adjust it. (The LCD monitor backlight has a limited life span. When the screen becomes dark or begins to flicker, contact your local EIZO representative.)
<p>2. Characters are blurred.</p>	<ul style="list-style-type: none"> Check whether the PC is configured to meet the resolution and vertical scan frequency requirements of the monitor (see “Compatible Resolutions” in the Setup Manual). When an image is displayed with a resolution other than recommended, the characters or lines of the displayed image may blur. Use “Smoothing” and “Screen Size” in the Setting menu to adjust the display (see “To modify blurred characters / lines” (page 18), and “Screen Size Changing” (page 19)).
<p>3. Afterimages appear.</p>	<ul style="list-style-type: none"> Afterimages are particular to LCD monitors. Avoid displaying the same image for a long time. Use the screen saver or power save function to avoid displaying the same image for extended periods of time.
<p>4. Green / red / blue / white dots or defective dots remain on the screen.</p>	<ul style="list-style-type: none"> This is due to LCD panel characteristics and is not a failure.
<p>5. Interference patterns or pressure marks remain on the screen.</p>	<ul style="list-style-type: none"> Leave the monitor with a white or black screen. The symptom may disappear.
<p>6. Noise appears on the screen.</p>	<ul style="list-style-type: none"> When entering the HDCP signals, the normal images may not be displayed immediately.

6-3. Imaging problems (for analog only)

Problem	Possible cause and remedy
<p>1. Display position is incorrect.</p> 	<ul style="list-style-type: none">• Use "Position" in the Setting menu to correct the image position (see "To correct the screen position" (page 17)).• If the problem persists, use the graphics board's utility if available to change the display position.
<p>2. Vertical bars appear on the screen or a part of the image is flickering.</p> 	<ul style="list-style-type: none">• Use "Clock" in the Setting menu to adjust it (see "To eliminate vertical bars" (page 16)).
<p>3. Whole screen is flickering or blurring.</p> 	<ul style="list-style-type: none">• Use "Phase" in the Setting menu to adjust it (see "To remove flickering or blurring" (page 17)).

6-4. Touch panel problems

Problem	Possible cause and remedy
1. Touch operation is disabled.	<ul style="list-style-type: none"> • Check that the monitor and PC are connected with a USB cable. • Check that the power cord of the monitor and PC is connected to a grounded main outlet. Failure to ground the equipment may result in malfunction.
2. Cursor position is not correct. / Cursor jumps.	<ul style="list-style-type: none"> • Connect the monitor to the PC with the cable indicated in the Setup Manual. The touch panel may not work correctly if a conversion adapter is used. • Turn off and on the monitor. • Calibrate the screen again. • Check that the power cord of the monitor and PC is connected to a grounded main outlet. Failure to ground the equipment may result in malfunction. • Changing the position or angle of the monitor may cause the cursor to jump. • If the touch panel is dirty, the touch panel may not operate properly. Refer to the User's Manual of the monitor to clean the touch panel. • The spray for preventing static electricity may influence the sensitivity of the touch panel. • Do not touch the touch panel for 5 seconds after the PC starts up, after turning on the monitor, or after connecting the USB cable. Touching the touch panel too soon may cause incorrect cursor positioning or disable touch operation. If this occurs, either leave the touch panel untouched for approximately 2 minutes or turn the monitor off and on again. If the problem persists, calibrate the screen again. • Changing the screen size of the monitor may cause the cursor position to become misaligned. Execute calibration again after changing the screen size.
3. The cursor does not appear at the touched position and instead is displayed at a point-symmetric position with respect to the center of the screen.	<ul style="list-style-type: none"> • Calibrate the screen again.
4. Calibration does not work correctly.	<ul style="list-style-type: none"> • Reset the touch panel to the state before calibration (by clicking "Reset" in the "Display" tab of the "Tablet PC Settings" window accessible from the Windows Control Panel) and then calibrate the touch panel again. • Once "Setup" has been completed in the "Display" tab of the "Tablet PC Settings" window accessible from the Windows Control Panel, close the "Tablet PC Settings" once, open the "Display" tab of "Tablet PC Settings" again, and then attempt calibration.
5. No touch-sound.	<ul style="list-style-type: none"> • This product does not feature touch sounds.

6-5. Other problems

Problem	Possible cause and remedy
1. The Setting menu does not appear.	<ul style="list-style-type: none">• Check whether the operation lock function is active (see “3-4. Locking Operation Buttons” (page 21)).
2. The “Smoothing” on the Setting menu “Screen” cannot be selected.	<ul style="list-style-type: none">• You cannot choose “smoothing” when the screen is displayed in the following resolutions or settings.<ul style="list-style-type: none">- The resolution is 1920 × 1080- Screen Size is “Normal”
3. The auto adjustment function does not work.	<ul style="list-style-type: none">• This function does not work during digital signal input.• This function operates correctly when images are displayed in the entire viewable area such as in Windows. It does not work properly when an image is displayed only on a part of the screen (command prompt window, for example) or when a black background (wallpaper, etc.) is in use.• This function does not work correctly with some graphics boards.
4. No audio output.	<ul style="list-style-type: none">• Check whether the stereo mini jack cable is connected properly.• Check whether volume is set to 0.• Check the setting of the PC and the audio playback software.• During DisplayPort signal input, check the “Source” setting (see “3-2. Selecting sound source while using the DisplayPort signal input” (page 20)).

Chapter 7 Reference

7-1. Attaching the Optional Arm

An optional arm (or an optional stand) can be attached by removing the stand section.

Attention

- When attaching an arm or stand, follow the instructions of their User's Manual.
- When using another manufacturer's arm or stand, confirm the following in advance and select one conforming to the VESA standard.
 - Clearance between the screw holes: 100 mm × 100 mm
 - Thickness of plate: 2.6 mm
 - Strong enough to support weight of the monitor unit (except the stand) and attachments such as cables.
- When using another manufacturer's arm or stand, use the screws as described below.
 - Screws fixing the stand to the monitor
- When using an arm or stand, attach it to meet the following tilt angles of the monitor.
 - Up 90° (landscape display / turned 90° clockwise to portrait display)
- When setting the monitor to the portrait style, turn the monitor screen 90° in clockwise direction.
- Connect the cables after attaching an arm or stand.
- Do not move the removed stand up and down. Doing so may result in injury or device damage.
- The monitor and arm or stand are heavy. Dropping them may result in injury or equipment damage.

Procedure

1. Lay the LCD monitor on a soft cloth spread over on a stable surface with the panel surface facing down.

2. Remove the stand.

Using a screwdriver, loosen the screws securing the unit and the stand.

3. Attach the arm or stand to the monitor.

Secure the monitor to the arm or stand using the screws specified in the User's Manual of the arm or stand.

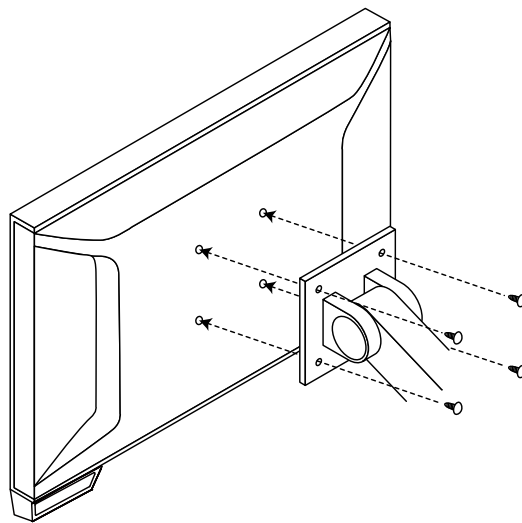

Note

- When using the LaidBack Stand and setting the monitor in the portrait orientation, remove the feet on the bottom of the monitor according to the following procedure.
 1. Remove the foot covers.

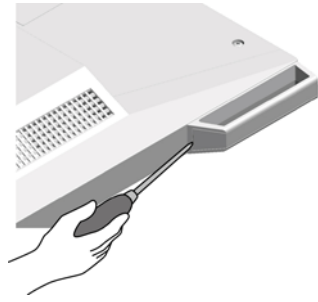

2. Remove the screw that secures each foot to the monitor.

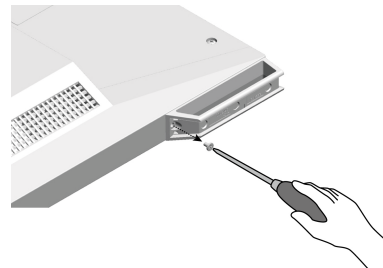

3. Slide each foot toward the edge of the monitor and remove them as shown below.



4. Seal the holes by adhering the supplied stickers.
- Store the removed parts in a safe place.
-

7-2. Connecting Multiple PCs

The product has multiple connections to PCs and allows you to switch to one of the connections for display.

Connection examples : LaidBack Stand

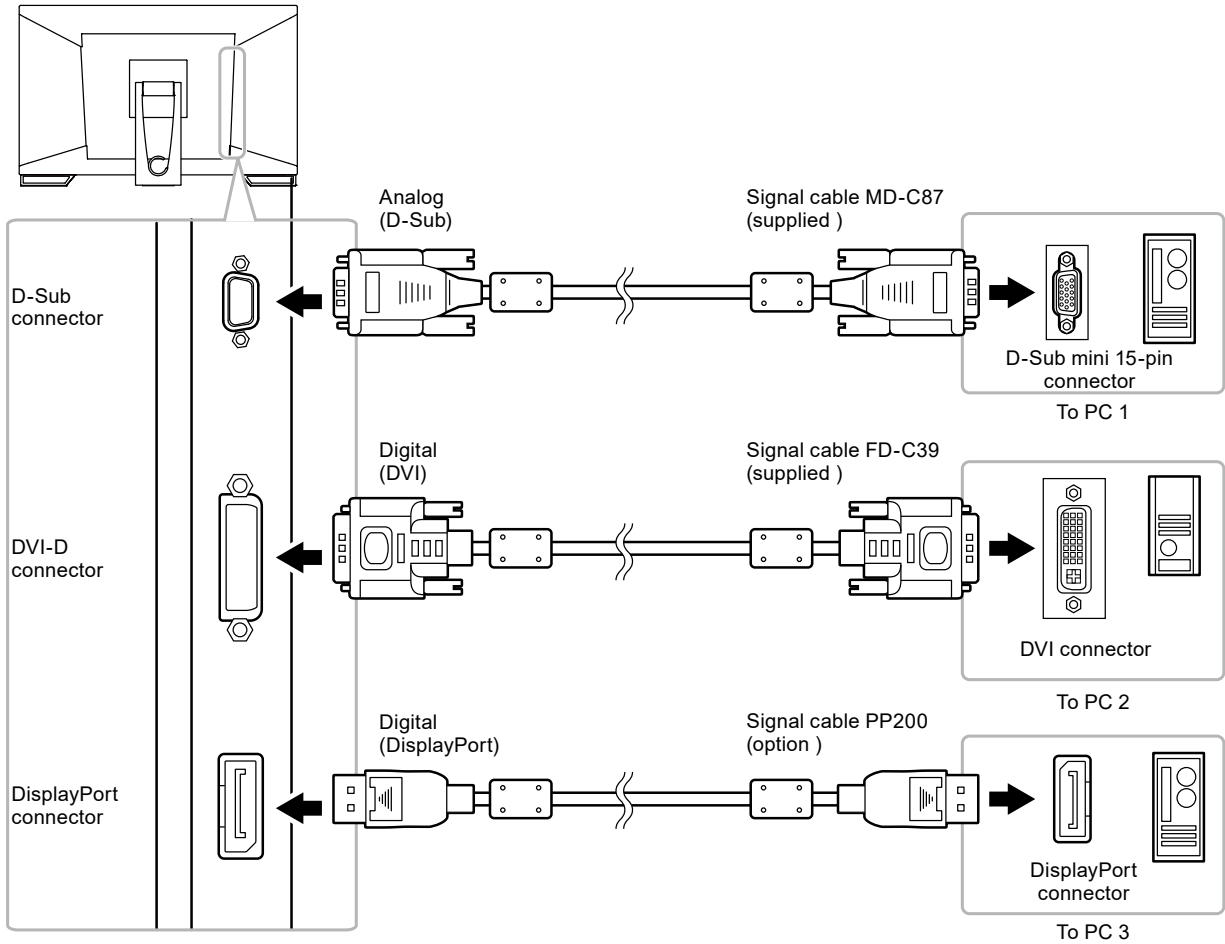

● To switch among input signals

The input signal switches each time SIGNAL is pressed.

When the signal is switched, the active input port name appears at the top right corner of the screen.

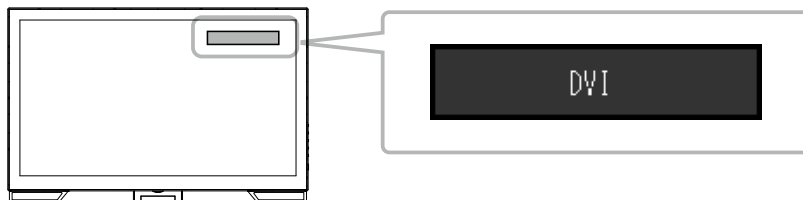

● To set input signal selection

Setting	Function
Auto	The monitor recognizes the connector through which PC signals are input. When a PC is turned off or enters the power saving mode, the monitor automatically displays another signal.
Manual	The monitor detects only the PC's signals currently displaying automatically. Select the input signal for display using the SIGNAL operation button.

Procedure

1. Choose "Monitor Settings" from the Adjustment menu, and press ENTER.
2. Choose "Input Signal" from "Monitor Settings", and press ENTER.
3. Select "Auto" or "Manual" with ▲ or ▼.
4. Press ENTER to exit.

Note

- If you select "Auto", the monitor enters the power saving mode after all the PCs have entered the power saving mode or have been switched off.
-

7-3. Displaying Monitor Information

This function allows you to display the model name, serial number, usage time, resolution, and input signal.

Procedure

1. Choose "Information" in the Setting menu, and press ENTER.
The "Information" menu appears.

Attention

- When you turn on the monitor for the first time, the usage time may be more than 0 due to a factory inspection.
-

7-4. Preset Timing

The following table shows factory preset analog signal timing.

Attention

- Display position may be deviated depending on the PC connected, which may require screen adjustment using Setting menu.
- If a signal other than those listed in the table is input, adjust the screen using the Setting menu. However, screen display may still be incorrect even after the adjustment.
- When interlace signals are used, the screen cannot be displayed correctly even after screen adjustment using the Setting menu.

Resolution	Applicable Signals	Frequency			Polarity	
		Dot Clock: MHz	Horizontal: kHz	Vertical: Hz	Horizontal	Vertical
640 × 480	VGA	25.18	31.47	59.94	Negative	Negative
640 × 480	VESA	31.50	37.86	72.81	Negative	Negative
640 × 480	VESA	31.50	37.50	75.00	Negative	Negative
720 × 400	VGA TEXT	28.32	31.47	70.09	Negative	Positive
800 × 600	VESA	36.00	35.16	56.25	Positive	Positive
800 × 600	VESA	40.00	37.88	60.32	Positive	Positive
800 × 600	VESA	50.00	48.08	72.19	Positive	Positive
800 × 600	VESA	49.50	46.88	75.00	Positive	Positive
1024 × 768	VESA	65.00	48.36	60.00	Negative	Negative
1024 × 768	VESA	75.00	56.48	70.07	Negative	Negative
1024 × 768	VESA	78.75	60.02	75.03	Positive	Positive
1280 × 720	CEA-861	74.25	45.00	60.00	Positive	Positive
1280 × 960	VESA	108.00	60.00	60.00	Positive	Positive
1280 × 1024	VESA	108.00	63.98	60.02	Positive	Positive
1280 × 1024	VESA	135.00	79.98	75.03	Positive	Positive
1680 × 1050	VESA CVT	146.25	65.29	59.95	Negative	Positive
1680 × 1050	VESA CVT RB	119.00	64.67	59.88	Positive	Negative
1920 × 1080	CEA-861	148.50	67.50	60.00	Positive	Positive

Chapter 8 Glossary

Clock

The analog signal input monitor needs to reproduce a clock of the same frequency as the dot clock of the graphics system in use, when the analog signal is converted to a digital signal for image display. This is called clock adjustment. If the clock pulse is not set correctly, some vertical bars appear on the screen.

DDC/CI (Display Data Channel/Command Interface)

VESA provides the standardization for the interactive communication of the setting information, etc. between a PC and the monitor.

DisplayPort

DisplayPort is a next-generation digital AV interface that allows connection of the PC, audio, imaging devices, etc. to the monitor. One cable can transfer sound with images.

DVI (Digital Visual Interface)

DVI is a digital interface standard. DVI allows direct transmission of the PC's digital data without loss.

This adopts the TMDS transmission system and DVI connectors. There are two types of DVI connectors. One is a DVI-D connector for digital signal input only. The other is a DVI-I connector for both digital and analog signal inputs.

DVI DMPM (DVI Digital Monitor Power Management)

DVI DMPM is a digital interface power saving function. The "Monitor ON (operating mode)" and "Active Off (power saving mode)" are indispensable for DVI DMPM as the monitor's power mode.

Gain

This is used to adjust each color parameter for red, green and blue. An LCD monitor displays the color by the light passing through the panel color filter. Red, green and blue are the three primary colors. All the colors on the screen are displayed by combining these three colors. The color tone can be changed by adjusting the light intensity (volume) passing through each color's filter.

Gamma

Generally, the monitor brightness varies nonlinearly with the input signal level, which is called "Gamma Characteristic". A small gamma value produces a low-contrast image, while a large gamma value produces a highcontrast image.

HDCP (High-bandwidth Digital Content Protection)

Digital signal coding system developed to copy-protect the digital contents, such as video, music, etc.

This helps to transmit the digital contents safely by coding the digital contents sent via the DVI or HDMI connector on the output side and decoding them on the input side.

Any digital contents cannot be reproduced if both of the equipments on the output and input sides are not applicable to HDCP system.

Phase

Phase means the sampling timing to convert the analog input signal to a digital signal. Phase adjustment is made to adjust the timing. It is recommended that phase adjustment be made after the clock is adjusted correctly.

Range Adjustment

Range adjustment controls the signal output levels to display every color gradation. It is recommended that range adjustment be made before color adjustment.

Resolution

The LCD panel consists of numerous pixels of specified size, which are illuminated to form images. This monitor consists of horizontal 1920 pixels and 1080 vertical pixels. At a resolution of 1920 × 1080, all pixels are illuminated as a full screen (1:1).

sRGB (Standard RGB)

International standard for color reproduction and color space among peripheral devices (such as monitors, printers, digital cameras, scanners). As a form of simple color matching for the Internet, colors can be displayed using tones close to those of the transmission and reception devices.

Temperature

Color temperature is a method to measure the white color tone, generally indicated in degrees Kelvin. The screen becomes reddish at a low temperature, and bluish at a high temperature, like the flame temperature.

5000 K: Slightly reddish white

6500 K: White referred to as daylight-balanced color

9300 K: Slightly bluish white

TMDs (Transition Minimized Differential Signaling)

A signal transmission system for digital interface.

VESA DPM (Video Electronics Standards Association - Display Power Management)

VESA specifications achieve increased energy efficiency for computer monitors. This involves standardization of signals sent from the computer (graphics board).

DPM defines the status of signals transmitted between the computer and monitor.

Appendix

Trademark

The terms HDMI and HDMI High-Definition Multimedia Interface, and the HDMI Logo are trademarks or registered trademarks of HDMI Licensing, LLC in the United States and other countries.

The DisplayPort Compliance Logo and VESA are registered trademarks of the Video Electronics Standards Association.

The SuperSpeed USB Trident Logo is a registered trademark of USB Implementers Forum, Inc.



DICOM is the registered trademark of the National Electrical Manufacturers Association for its standards publications relating to digital communications of medical information.

Kensington and Microsaver are registered trademarks of ACCO Brands Corporation.

Thunderbolt is a trademark of Intel Corporation in the United States and/or other countries.

Microsoft and Windows are registered trademarks of Microsoft Corporation in the United States and other countries.

Adobe is a registered trademark of Adobe Systems Incorporated in the United States and other countries.

Apple, macOS, Mac OS, OS X, Macintosh and ColorSync are registered trademarks of Apple Inc.

EIZO, the EIZO Logo, ColorEdge, CuratOR, DuraVision, FlexScan, FORIS, RadiCS, RadiForce, RadiNET, Raptor and ScreenManager are registered trademarks of EIZO Corporation in Japan and other countries.

ColorEdge Tablet Controller, ColorNavigator, EcoView NET, EIZO EasyPIX, EIZO Monitor Configurator, EIZO ScreenSlicer, G-Ignition, i•Sound, Quick Color Match, RadiLight, Re/Vue, Screen Administrator, Screen InStyle and UniColor Pro are trademarks of EIZO Corporation.

All other company and product names are trademarks or registered trademarks of their respective owners.

License / Copyright

A round gothic bold bit map font designed by Ricoh is used for the characters displayed on this product.

FCC Declaration of Conformity

For U.S.A. , Canada, etc. (rated 100-120 Vac) Only

FCC Declaration of Conformity

We, the Responsible Party

EIZO Inc.

5710 Warland Drive, Cypress, CA 90630

Phone: (562) 431-5011

declare that the product

Trade name: EIZO

Model: DuraVision FDF2121WT-A

is in conformity with Part 15 of the FCC Rules. Operation of this product is subject to the following two conditions: (1) this device may not cause harmful interference, and (2) this device must accept any interference received, including interference that may cause undesired operation.

This equipment has been tested and found to comply with the limits for a Class B digital device, pursuant to Part 15 of the FCC Rules. These limits are designed to provide reasonable protection against harmful interference in a residential installation. This equipment generates, uses, and can radiate radio frequency energy and, if not installed and used in accordance with the instructions, may cause harmful interference to radio communications. However, there is no guarantee that interference will not occur in a particular installation. If this equipment does cause harmful interference to radio or television reception, which can be determined by turning the equipment off and on, the user is encouraged to try to correct the interference by one or more of the following measures.

- * Reorient or relocate the receiving antenna.
- * Increase the separation between the equipment and receiver.
- * Connect the equipment into an outlet on a circuit different from that to which the receiver is connected.
- * Consult the dealer or an experienced radio/TV technician for help.

Changes or modifications not expressly approved by the party responsible for compliance could void the user's authority to operate the equipment.

Note

Use the attached specified cable below or EIZO signal cable with this monitor so as to keep interference within the limits of a Class B digital device.

- AC Cord
- Shielded Signal Cable (enclosed)

Canadian Notice

This Class B digital apparatus complies with Canadian ICES-003.

Cet appareil numérique de la classe B est conforme à la norme NMB-003 du Canada.

LIMITED WARRANTY

LIMITED WARRANTY

EIZO Corporation (hereinafter referred to as “**EIZO**”) and distributors authorized by EIZO (hereinafter referred to as the “**Distributors**”) warrant, subject to and in accordance with the terms of this limited warranty (hereinafter referred to as the “**Warranty**”), to the original purchaser (hereinafter referred to as the “**Original Purchaser**”) who purchased the product specified in this document (hereinafter referred to as the “**Product**”) from EIZO or Distributors, that EIZO and Distributors shall, at their sole discretion, either repair or replace the Product at no charge if the Original Purchaser becomes aware within the Warranty Period (defined below) that the Product malfunctions or is damaged in the course of normal use of the Product in accordance with the description in the instruction manual attached to the Product (hereinafter referred to as the “**User’s Manual**”).

The period of this Warranty is three (3) years from the date of purchase of the Product (hereinafter referred to as the “**Warranty Period**”). EIZO and Distributors shall bear no liability or obligation with regard to the Product in relation to the Original Purchaser or any third parties other than as provided under this Warranty.

EIZO and Distributors will cease to hold or store any parts (excluding design parts) of the Product upon expiration of seven (7) years after the production of such parts is discontinued. In repairing the monitor, EIZO and Distributors will use renewal parts which comply with our QC standards. If the unit cannot be repaired due to its condition or the stockout of a relevant part, EIZO and Distributors may offer the replacement by a product with equivalent performance instead of repairing it.

The Warranty is valid only in the countries or territories where the Distributors are located. The Warranty does not restrict any legal rights of the Original Purchaser.

Notwithstanding any other provision of this Warranty, EIZO and Distributors shall have no obligation under this Warranty whatsoever in any of the cases as set forth below:

- (a) Any defect of the Product caused by freight damage, modification, alteration, abuse, misuse, accident, incorrect installation, disaster, faulty maintenance and/or improper repair by third party other than EIZO and Distributors;
- (b) Any incompatibility of the Product due to possible technical innovations and/or regulations;
- (c) Any deterioration of the sensor;
- (d) Any deterioration of display performance caused by the deterioration of expendable parts such as the LCD panel and/or backlight, etc. (e.g. changes in brightness, changes in brightness uniformity, changes in color, changes in color uniformity, defects in pixels including burnt pixels, etc.);
- (e) Any defect of the Product caused by placement in a location where it may be affected by strong vibration or shocks;
- (f) Any defect of the Product caused by external equipment;
- (g) Any defect of the Product on which the original serial number has been altered or removed;
- (h) Any defect of the Product caused by liquid leaking from battery;
- (i) Any normal deterioration of the product, particularly that of consumables, accessories, and/or attachments (e.g. buttons, rotating parts, cables, User’s Manual, etc.); and
- (j) Any deformation, discoloration, warp, and/or rust of the exterior of the product including that of the surface of the LCD panel.

To obtain service under the Warranty, the Original Purchaser must deliver the Product, freight prepaid, in its original package or other adequate package affording an equal degree of protection, assuming the risk of damage and/or loss in transit, to the local Distributor. The Original Purchaser must present proof of purchase of the Product and the date of such purchase when requesting services under the Warranty.

The Warranty Period for any replaced and/or repaired product under this Warranty shall expire at the end of the original Warranty Period.

EIZO OR DISTRIBUTORS ARE NOT RESPONSIBLE FOR ANY DAMAGE TO, OR LOSS OF, DATA OR OTHER INFORMATION STORED IN ANY MEDIA OR ANY PART OF ANY PRODUCT RETURNED TO EIZO OR DISTRIBUTORS FOR REPAIR.

EIZO AND DISTRIBUTORS MAKE NO FURTHER WARRANTIES, EXPRESSED OR IMPLIED, WITH RESPECT TO THE PRODUCT AND ITS QUALITY, PERFORMANCE, MERCHANTABILITY OR FITNESS FOR ANY PARTICULAR USE. IN NO EVENT SHALL EIZO OR DISTRIBUTORS BE LIABLE FOR ANY INCIDENTAL, INDIRECT, SPECIAL, CONSEQUENTIAL OR OTHER DAMAGE WHATSOEVER (INCLUDING, WITHOUT LIMITATION, DAMAGES FOR LOSS OF PROFIT, BUSINESS INTERRUPTION, LOSS OF BUSINESS INFORMATION, OR ANY OTHER PECUNIARY LOSS) ARISING OUT OF THE USE OR INABILITY TO USE THE PRODUCT OR IN ANY CONNECTION WITH THE PRODUCT, WHETHER BASED ON CONTRACT, TORT, NEGLIGENCE, STRICT LIABILITY OR OTHERWISE, EVEN IF EIZO OR DISTRIBUTORS HAVE BEEN ADVISED OF THE POSSIBILITY OF SUCH DAMAGES. THIS EXCLUSION ALSO INCLUDES ANY LIABILITY WHICH MAY ARISE OUT OF THIRD PARTY CLAIMS AGAINST THE ORIGINAL PURCHASER. THE ESSENCE OF THIS PROVISION IS TO LIMIT THE POTENTIAL LIABILITY OF EIZO AND DISTRIBUTORS ARISING OUT OF THIS LIMITED WARRANTY AND/OR SALES.

BEGRENZTE GARANTIE

EIZO Corporation (im Weiteren als „**EIZO**“ bezeichnet) und die Vertragsimporteure von EIZO (im Weiteren als „**Vertrieb(e)**“ bezeichnet) garantieren dem ursprünglichen Käufer (im Weiteren als „**Erstkäufer**“ bezeichnet), der das in diesem Dokument vorgegebene Produkt (im Weiteren als „**Produkt**“ bezeichnet) von EIZO oder einem Vertrieb erworben hat, gemäß den Bedingungen dieser beschränkten Garantie (im Weiteren als „**Garantie**“ bezeichnet), dass EIZO und der Vertrieb nach eigenem Ermessen das Produkt entweder kostenlos reparieren oder austauschen, falls der Erstkäufer innerhalb der Garantiefrist (weiter unten festgelegt) eine Fehlfunktion bzw. Beschädigung des Produkts feststellt, die während des normalen Gebrauchs des Produkts gemäß den Anweisungen des zum Lieferumfang des Produkts gehörenden Benutzerhandbuchs (im Weiteren als „**Benutzerhandbuch**“ bezeichnet) aufgetreten ist.

Die Dauer der Garantieleistung (im Weiteren als „**Garantiefrist**“ bezeichnet) beträgt drei (3) Jahre ab dem Kaufdatum des Produkts. EIZO und die Vertriebe übernehmen über den Rahmen dieser Garantie hinaus hinsichtlich des Produkts keinerlei Haftung oder Verpflichtung dem Erstkäufer oder Dritten gegenüber.

Nach Ablauf von sieben (7) Jahren nach Ende der Produktion solcher Teile werden EIZO und Vertriebshändler keine Teile (mit Ausnahme von Konstruktionsteilen) mehr vorhalten und lagern. EIZO und seine Vertriebspartner verpflichten sich, bei einer etwaigen Reparatur des Monitors ausschließlich Produkte gemäß den EIZO-Qualitätssicherungsstandards zu verwenden. Wenn das Gerät aufgrund seines Zustands oder eines Fehlbestands bei einem entsprechenden Teil nicht repariert werden kann, können EIZO und Vertriebshändler statt der Reparatur des Geräts den Austausch gegen ein Produkt mit gleichwertiger Leistung anbieten.

Diese Garantie gilt nur in Ländern oder Gebieten, in denen sich Vertriebe befinden. Die gesetzlichen Gewährleistungsrechte des Erstkäufers gegenüber dem Verkäufer werden durch diese Garantie nicht berührt.

EIZO und die Vertriebe besitzen im Rahmen dieser Garantie keinerlei Verpflichtung in den folgenden Fällen:

- (a) Produktdefekte, die auf Frachtschäden, Modifikation, Nachgestaltung, Missbrauch, Fehlbedienung, Unfälle, unsachgemäße Installation, Naturkatastrophen, fehlerhafte Wartung und/oder unsachgemäße Reparatur durch eine andere Partei als EIZO und die Vertriebe zurückzuführen sind.
- (b) Eine Inkompatibilität des Produkts aufgrund von technischen Neuerungen und/oder neuen Bestimmungen, die nach dem Kauf in Kraft treten.
- (c) Jegliche Verschlechterung des Sensors.
- (d) Jegliche Verschlechterung der Bildschirmleistung, die durch Verschleißteile wie das LCD-Panel und/oder die Hintergrundbeleuchtung usw. hervorgerufen werden (z.B. Veränderungen von Helligkeit oder Helligkeitsverteilung, Veränderungen von Farbe oder Farbverteilung, Pixeldefekte einschließlich von durchgebrannten Pixeln usw.).
- (e) Produktdefekte, die durch Platzierung an einer Stelle verursacht werden, wo das Produkt von starker Vibration oder Schocks betroffen sein könnte.
- (f) Produktdefekte, die durch externe Geräte verursacht werden.
- (g) Jeglicher Defekt eines Produkts, dessen ursprüngliche Seriennummer geändert oder entfernt wurde.
- (h) Produktdefekte, die durch Austritt von Batterieflüssigkeit verursacht werden.
- (i) Normale Abnutzung des Produkts, insbesondere von Verbrauchsteilen, Zubehöerteilen und/oder Beilagen (z.B. Tasten, drehbare Teile, Kabel, Benutzerhandbuch usw.); sowie
- (j) Verformungen, Verfärbungen, Verziehungen und/oder Rost am Produktäußeren, einschließlich der Oberfläche des LCD-Panels.

Bei Inanspruchnahme der Garantieleistung ist der Erstkäufer verpflichtet, das Produkt auf eigene Kosten und in der Originalverpackung bzw. einer anderen geeigneten Verpackung, die einen gleichwertigen Schutz gegen Transportschäden bietet, an den örtlichen Vertrieb zu übersenden, wobei der Erstkäufer das Transportrisiko gegenüber Schäden und/oder Verlust trägt. Zum Zeitpunkt der Inanspruchnahme der Garantieleistung muss der Erstkäufer einen Verkaufsbeleg vorweisen, auf dem das Kaufdatum angegeben ist.

Die Garantiefrist für ein im Rahmen dieser Garantie ausgetauschtes und/oder repariertes Produkt erlischt nach Ablauf der ursprünglichen Garantiefrist.

EIZO ODER DIE EIZO-VERTRAGSIMPORTEURE HAFTEN NICHT FÜR ZERSTÖRTE DATENBESTÄNDE ODER DIE KOSTEN DER WIEDERBESCHAFFUNG DIESER DATENBESTÄNDE AUF JEDLICHEN DATENTRÄGERN ODER TEILEN DES PRODUKTS, DIE IM RAHMEN DER GARANTIE BEI EIZO ODER DEN EIZO-VERTRAGSIMPORTEUREN ZUR REPARATUR EINGEREICHT WURDEN.

EIZO UND DIE EIZO-VERTRAGSIMPORTEURE GEBEN WEDER EXPLIZITE NOCH IMPLIZITE GARANTIE IN BEZUG AUF DIESES PRODUKT UND SEINE QUALITÄT, LEISTUNG, VERKÄUFLICHKEIT ODER EIGNUNG FÜR EINEN BESTIMMTEN ZWECK. AUF KEINEN FALL SIND EIZO ODER DIE EIZO-VERTRAGSIMPORTEURE VERANTWORTLICH FÜR JEDLICHE ZUFÄLLIGE, INDIREKTE, SPEZIELLE, FOLGE- ODER ANDERE SCHÄDEN JEDLICHER ART (EINSCHLIESSLICH OHNE JEDE BEGRENZUNG SCHÄDEN BEZÜGLICH PROFITVERLUST, GESCHÄFTSUNTERBRECHUNG, VERLUST VON GESCHÄFTSINFORMATION ODER JEDLICHE ANDEREN FINANZIELLEN EINBUSSEN), DIE DURCH DIE VERWENDUNG DES PRODUKTES ODER DIE UNFÄHIGKEIT ZUR VERWENDUNG DES PRODUKTES ODER IN JEDLICHER BEZIEHUNG MIT DEM PRODUKT, SEI ES BASIEREND AUF VERTRAG, SCHADENSERSATZ, NACHLAESSIGKEIT, STRIKTE HAFTPFLICHT ODER ANDEREN FORDERUNGEN ENTSTEHEN, AUCH WENN EIZO UND DIE EIZO-VERTRAGSIMPORTEURE IM VORAUS ÜBER DIE MÖGLICHKEIT SOLCHER SCHÄDEN INFORMIERT WURDEN. DIESER AUSSCHLUSS ENTHÄLT AUCH JEDE HAFTPFLICHT, DIE AUS FORDERUNGEN DRITTER GEGEN DEN ERSTKÄUFER ENTSTEHEN KANN. ZWECK DIESER KLAUSEL IST ES, DIE HAFTUNG VON EIZO UND DEN VERTRIEBEN GEGENÜBER FORDERUNGEN ZU BEGRENZEN, DIE AUS DIESER BESCHRÄNKTEN GARANTIE UND/ODER DEM VERKAUF ENTSTEHEN KÖNNEN.

GARANTIE LIMITÉE

EIZO Corporation (ci-après dénommé « **EIZO** ») et les distributeurs autorisés par EIZO (ci-après dénommés « **Distributeurs** »), sous réserve et conformément aux termes de cette garantie limitée (ci-après dénommée « **Garantie** »), garantissent à l'acheteur initial (ci-après dénommé « **Acheteur initial** ») du produit spécifié dans la présente (ci-après dénommé « **Produit** ») acheté auprès d'EIZO ou de Distributeurs agréés EIZO, que EIZO et ses Distributeurs auront pour option de réparer ou remplacer gratuitement le Produit si l'Acheteur initial constate, pendant la Période de garantie (définie ci-dessous), qu'il y a un dysfonctionnement ou que le Produit a subi un dommage dans le cadre d'une utilisation normale du Produit conformément à la description du mode d'emploi qui accompagne le Produit (ci-après dénommé « **Manuel d'utilisation** »).

La période de cette Garantie est de trois (3) ans à partir de la date d'achat du Produit (ci-après dénommée « **Période de Garantie** »). EIZO et ses Distributeurs déclinent toute responsabilité ou obligation concernant ce Produit face à l'Acheteur initial ou à toute autre personne à l'exception de celles stipulées dans la présente Garantie.

EIZO et ses Distributeurs cesseront de conserver ou de stocker des pièces (à l'exception des pièces de conception) du Produit à l'expiration d'une période de sept (7) ans après l'arrêt de la production de ces pièces. Pour réparer le moniteur, EIZO et ses distributeurs utiliseront des pièces de rechange conformes à nos normes de contrôle qualité. Si l'unité ne peut pas être réparée en raison de son état ou de la rupture de stock d'une pièce adéquate, EIZO et ses Distributeurs peuvent proposer le remplacement par un produit aux performances équivalentes au lieu de le réparer.

La Garantie est valable uniquement dans les pays ou les territoires où se trouvent les Distributeurs. La Garantie ne limite aucun des droits reconnus par la loi à l'Acheteur initial.

Nonobstant toute autre clause de cette Garantie, EIZO et ses Distributeurs n'auront d'obligation dans le cadre de cette Garantie pour aucun des cas énumérés ci-dessous :

- (a) Tout défaut du Produit résultant de dommages occasionnés lors du transport, d'une modification, d'une altération, d'un abus, d'une mauvaise utilisation, d'un accident, d'une installation incorrecte, d'un désastre, d'un entretien et/ou d'une réparation incorrects effectués par une personne autre que EIZO ou ses Distributeurs ;
- (b) Toute incompatibilité du Produit résultant d'améliorations techniques et/ou réglementations possibles ;
- (c) Toute détérioration du capteur ;
- (d) Toute détérioration des performances d'affichage causée par la détérioration des éléments consommables tels que le panneau LCD et/ou le rétroéclairage, etc. (par exemple des changements de luminosité, des changements de l'uniformité de la luminosité, des modifications de couleur, des changements de l'uniformité des couleurs, des défauts de pixels y compris des pixels brûlés, etc.);
- (e) Tout défaut du Produit causé par le placement dans un endroit où il pourrait être affecté par de fortes vibrations ou chocs ;
- (f) Tout défaut du Produit causé par un appareil externe ;
- (g) Tout défaut d'un Produit sur lequel le numéro de série original a été altéré ou supprimé ;
- (h) Tout défaut du Produit causé par un écoulement du liquide contenu dans les piles ;
- (i) Toute détérioration normale du Produit, particulièrement celle des consommables, des accessoires et/ou des pièces reliées au Produit (touches, éléments pivotants, câbles, Manuel d'utilisation etc.), et
- (j) Toute déformation, décoloration, gondolage et/ou rouille de l'extérieur du Produit, y compris celle de la surface du panneau LCD.

Pour bénéficier d'un service dans le cadre de cette Garantie, l'Acheteur initial doit renvoyer le Produit port payé, dans son emballage d'origine ou tout autre emballage approprié offrant un degré de protection équivalent, au Distributeur local, et assumera la responsabilité des dommages et/ou perte possibles lors du transport. L'Acheteur initial doit présenter une preuve d'achat du Produit comprenant sa date d'achat pour bénéficier de ce service dans le cadre de la Garantie.

La Période de garantie pour tout Produit remplacé et/ou réparé dans le cadre de cette Garantie expirera à la fin de la Période de garantie initiale.

EIZO OU SES DISTRIBUTEURS NE SAURAIENT ÊTRE TENUS RESPONSABLES DES DOMMAGES OU PERTES DE DONNÉES OU D'AUTRES INFORMATIONS STOCKÉES DANS UN MÉDIA QUELCONQUE OU UNE AUTRE PARTIE DU PRODUIT RENVOYÉ À EIZO OU AUX DISTRIBUTEURS POUR RÉPARATION.

AUCUNE AUTRE GARANTIE, EXPLICITE OU TACITE, N'EST OFFERTE PAR EIZO ET SES DISTRIBUTEURS CONCERNANT LE PRODUIT ET SES QUALITÉS, PERFORMANCES, QUALITÉ MARCHANDE OU ADAPTATION À UN USAGE PARTICULIER. EN AUCUN CAS, EIZO OU SES DISTRIBUTEURS NE SERONT RESPONSABLES DES DOMMAGES FORTUITS, INDIRECTS, SPÉCIAUX, INDUITS, OU DE TOUT AUTRE DOMMAGE QUEL QU'IL SOIT (Y COMPRIS, SANS LIMITATION, LES DOMMAGES RÉSULTANT D'UNE PERTE DE PROFIT, D'UNE INTERRUPTION D'ACTIVITÉS, D'UNE PERTE DE DONNÉES COMMERCIALES, OU DE TOUT AUTRE MANQUE À GAGNER) RÉSULTANT DE L'UTILISATION OU DE L'INCAPACITÉ D'UTILISER LE PRODUIT OU AYANT UN RAPPORT QUELCONQUE AVEC LE PRODUIT, QUE CE SOIT SUR LA BASE D'UN CONTRAT, D'UN TORT, D'UNE NÉGLIGENCE, D'UNE RESPONSABILITÉ STRICTE OU AUTRE, MÊME SI EIZO OU SES DISTRIBUTEURS ONT ÉTÉ AVERTIS DE LA POSSIBILITÉ DE TELS DOMMAGES. CETTE LIMITATION INCLUT AUSSI TOUTE RESPONSABILITÉ QUI POURRAIT ÊTRE SOULEVÉE LORS DES RÉCLAMATIONS D'UN TIERS CONTRE L'ACHETEUR INITIAL. L'ESSENCE DE CETTE CLAUSE EST DE LIMITER LA RESPONSABILITÉ POTENTIELLE DE EIZO ET DE SES DISTRIBUTEURS RÉSULTANT DE CETTE GARANTIE LIMITÉE ET/OU DES VENTES.

GARANTÍA LIMITADA

EIZO Corporation (en lo sucesivo “EIZO”) y sus distribuidores autorizados (en lo sucesivo los “Distribuidores”), con arreglo y de conformidad con los términos de esta garantía limitada (en lo sucesivo la “Garantía”), garantizan al comprador original (en lo sucesivo el “Comprador original”) que compró el producto especificado en este documento (en lo sucesivo el “Producto”) a EIZO o a sus Distribuidores, que EIZO y sus Distribuidores, a su propio criterio, repararán o sustituirán el Producto de forma gratuita si el Comprador original detecta dentro del periodo de la Garantía (indicado posteriormente) que el Producto no funciona correctamente o que se ha averiado durante el uso normal del mismo de acuerdo con las indicaciones del manual de instrucciones suministrado con el Producto (en lo sucesivo el “Manual del usuario”).

El periodo de esta Garantía es de tres (3) años a partir de la fecha de compra del Producto (en adelante designado como el “Periodo de Garantía”). EIZO y sus Distribuidores no tendrán ninguna responsabilidad ni obligación con respecto al Producto para con el Comprador original ni con terceros que no sean las estipuladas en la presente Garantía.

EIZO y sus distribuidores dejarán de tener o almacenar cualquier pieza del producto (excepto piezas del diseño) una vez expirado el periodo de siete (7) años después de que hayan dejado de fabricarse tales piezas. Para la reparación del monitor, EIZO y los distribuidores utilizarán repuestos que cumplan con nuestros estándares de control de calidad. Si no se puede reparar la unidad debido a su estado o si se han agotado las existencias de una pieza importante, EIZO y sus distribuidores podrán ofrecerle sustituirlo por un producto con rendimiento equivalente en lugar de repararlo.

La Garantía es válida sólo en los países y territorios donde están ubicados los Distribuidores. La Garantía no restringe ningún derecho legal del Comprador original.

A pesar de las estipulaciones de esta Garantía, EIZO y sus Distribuidores no tendrán obligación alguna bajo esta Garantía en ninguno de los casos expuestos a continuación:

- (a) Cualquier defecto del Producto causado por daños en el transporte, modificación, alteración, abuso, uso incorrecto, accidente, instalación incorrecta, desastre, mantenimiento incorrecto y/o reparación indebida realizada por un tercero que no sea EIZO o sus Distribuidores.
- (b) Cualquier incompatibilidad del Producto debida a posibles innovaciones técnicas y/o reglamentaciones.
- (c) Cualquier deterioro del sensor.
- (d) Cualquier deterioro en el rendimiento de la visualización causado por fallos en las piezas consumibles como el panel LCD y/o la "Backlight", etc. (p. ej. cambios de brillo, cambios de uniformidad del brillo, cambios de color, cambios de uniformidad del color, defectos de píxeles, incluyendo píxeles muertos, etc.).
- (e) Cualquier defecto del Producto provocado por su colocación en un lugar donde pueda verse afectado por fuertes vibraciones o sacudidas.
- (f) Cualquier defecto del Producto causado por un equipo externo.
- (g) Cualquier defecto del Producto en el que haya sido alterado o borrado el número de serie original.
- (h) Cualquier defecto del Producto casusado por fugas de líquido de las pilas.
- (i) Cualquier deterioro normal del Producto, y en particular de las piezas consumibles, accesorios y demás (p. ej. botones, piezas giratorias, cables, Manual del usuario, etc.).
- (j) Cualquier deformación, decoloración, alabeo y/u oxidación del exterior del Producto incluida la superficie del panel LCD.

Para obtener servicio en los términos de esta Garantía, el Producto deberá ser enviado por el Comprador original, a su Distribuidor local, con el transporte previamente pagado, en el embalaje original u otro embalaje adecuado que ofrezca el mismo grado de protección, asumiendo el riesgo de daños y/o pérdida del Producto durante el transporte. El Comprador original deberá presentar un comprobante de compra del Producto en el que se refleje la fecha de compra del mismo cuando lo solicite el servicio de Garantía.

El Periodo de garantía para cualquier Producto reemplazado y/o reparado en los términos de esta Garantía expirará al vencer el Periodo de garantía original.

EIZO O LOS DISTRIBUIDORES AUTORIZADOS DE EIZO NO SE RESPONSABILIZAN DE NINGÚN DAÑO O PÉRDIDA QUE PUEDAN SUFRIR LOS DATOS U OTRA INFORMACIÓN ALMACENADA EN CUALQUIER MEDIO O CUALQUIER PARTE DE CUALQUIER PRODUCTO DEVUELTO A EIZO O A LOS DISTRIBUIDORES DE EIZO PARA SU REPARACIÓN.

EIZO Y LOS DISTRIBUIDORES AUTORIZADOS DE EIZO NO OFRECEN NINGUNA OTRA GARANTÍA, IMPLÍCITA NI EXPLÍCITA, CON RESPECTO AL PRODUCTO Y A SU CALIDAD, RENDIMIENTO, COMERCIALIZACIÓN E IDONEIDAD PARA CUALQUIER USO EN PARTICULAR. EN NINGÚN CASO SERÁN EIZO O LOS DISTRIBUIDORES AUTORIZADOS DE EIZO RESPONSABLES DE NINGÚN DAÑO EMERGENTE, INDIRECTO, ESPECIAL, INHERENTE O CUALQUIERA QUE SEA (INCLUYENDO, SIN LIMITACIÓN, DAÑOS POR LUCRO CESANTE, INTERRUPCIÓN DE LA ACTIVIDAD COMERCIAL, PÉRDIDA DE INFORMACIÓN COMERCIAL O CUALQUIER OTRA PÉRDIDA PECUNIARIA) QUE SE DERIVE DEL USO O IMPOSIBILIDAD DE USO DEL PRODUCTO O EN RELACIÓN CON EL PRODUCTO, YA SEA BASADO EN CONTRATO, POR AGRAVIO, NEGLIGENCIA, ESTRICTA RESPONSABILIDAD O CUALQUIERA QUE SEA, AUN CUANDO SE HAYA ADVERTIDO A EIZO O A LOS DISTRIBUIDORES DE EIZO DE LA POSIBILIDAD DE TALES DAÑOS. ESTA EXCLUSIÓN TAMBIÉN ABARCA CUALQUIER RESPONSABILIDAD QUE PUEDA DERIVARSE DE RECLAMACIONES HECHAS POR UN TERCERO CONTRA EL COMPRADOR ORIGINAL. LA ESENCIA DE ESTA ESTIPULACIÓN ES LIMITAR LA RESPONSABILIDAD POTENCIAL DE EIZO Y LOS DISTRIBUIDORES QUE PUDIERA DERIVARSE DE ESTA GARANTÍA LIMITADA Y/O VENTAS.

GARANZIA LIMITATA

EIZO Corporation (a cui si farà riferimento da qui in poi con “**EIZO**”) ed i Distributori autorizzati da EIZO (a cui si farà riferimento da qui in poi con “**Distributori**”) garantiscono, secondo i termini di questa garanzia limitata (a cui si farà riferimento da qui in poi con “**Garanzia**”) all’acquirente originale (a cui si farà riferimento da qui in poi con “**Acquirente originale**”) che ha acquistato il prodotto specificato in questo documento (a cui si farà riferimento da qui in poi con “**Prodotto**”) da EIZO o dai suoi Distributori, che EIZO e i distributori, a loro discrezione, ripareranno o sostituiranno il Prodotto senza addebito se l’Acquirente originale trova, entro il periodo della Garanzia (definito sotto), che il Prodotto malfunziona e si è danneggiato nel corso del suo normale utilizzo osservando le indicazioni del manuale di istruzioni allegato al Prodotto (a cui si farà riferimento da qui in poi con “**Manuale utente**”).

Il periodo di questa Garanzia è di tre (3) anni dalla data di acquisto del Prodotto (a cui si farà riferimento da qui in poi con “**Periodo di Garanzia**”). EIZO e i suoi Distributori non si assumono alcuna responsabilità e non hanno alcun obbligo riguardo al Prodotto verso l’Acquirente originale o terzi diversi da quelli relativi a questa Garanzia.

EIZO e i distributori cesseranno lo stoccaggio dei componenti (tranne le parti relative al progetto) del prodotto dopo sette (7) anni dall’interruzione della produzione di tali componenti. Per la riparazione del monitor, EIZO e i Distributori utilizzeranno parti di ricambio conformi ai nostri standard di controllo della qualità. Se l’unità non può essere riparata a causa delle sue condizioni o dell’esaurimento scorte di un componente rilevante, EIZO e i distributori potrebbero offrire la sostituzione con un prodotto con prestazioni equivalenti piuttosto ripararlo.

La Garanzia è valida soltanto nei paesi dove ci sono i Distributori EIZO. La Garanzia non limita alcun diritto legale dell’Acquirente originale.

Indipendentemente da qualsiasi altra condizione di questa Garanzia, EIZO e i suoi Distributori non avranno alcun obbligo derivante da questa Garanzia in ognuno dei casi elencati di seguito:

- (a) Qualsiasi difetto del Prodotto causato da danni di trasporto, modifiche, alterazioni, abusi, usi impropri, incidenti, installazione errata, calamità, manutenzione errata e/o riparazioni improprie eseguite da terze parti che non siano EIZO o i suoi Distributori.
- (b) Qualsiasi incompatibilità del Prodotto dovuta a possibili innovazioni tecniche e/o normative.
- (c) Qualsiasi deterioramento del sensore.
- (d) Qualsiasi deterioramento delle prestazioni dello schermo causato dal deterioramento delle parti consumabili, come il pannello LCD e/o la retroilluminazione, ecc. (per esempio: i cambiamenti di luminosità, cambiamenti di uniformità della luminosità, i cambiamenti di colore, i cambiamenti di uniformità del colore, i difetti dei pixel, inclusi i pixel bruciati, ecc.).
- (e) Qualsiasi difetto del Prodotto dovuto alla sua collocazione in un luogo che può assoggettarlo a forti vibrazioni o urti.
- (f) Qualsiasi difetto del Prodotto causato da apparecchiature esterne.
- (g) Qualsiasi difetto del Prodotto in cui il numero di serie originale sia stato alterato o rimosso.
- (h) Qualsiasi difetto del Prodotto causato dalla fuoriuscita di liquido dalle pile.
- (i) Qualsiasi normale deterioramento del Prodotto, in particolar modo nelle sue parti di consumo, accessori, e/o attacchi (per esempio: tasti, parti rotanti, cavi, Manuale dell’utente, ecc.).
- (j) Qualsiasi tipo di deformazione, scolorimento, alterazione e/o arrugginimento dell’involucro esterno del Prodotto inclusa la superficie del pannello LCD.

Per ricevere assistenza tecnica con questa Garanzia, l’Acquirente originale deve inviare il Prodotto, con trasporto pre-pagato, nella sua confezione originale o altra confezione adeguata che fornisce un livello analogo di protezione, assumendosi il rischio di danni e/o perdita in transito, al Distributore locale. L’Acquirente originale deve presentare la prova di acquisto che stabilisce la data di acquisto del Prodotto quando richiede servizio sotto Garanzia.

Il Periodo di garanzia per qualsiasi Prodotto sostituito e/o riparato sotto questa Garanzia scade alla fine del Periodo di garanzia originale.

EIZO O I SUOI DISTRIBUTORI NON SONO RESPONSABILI PER QUALSIASI DANNO O PERDITA DI DATI O ALTRE INFORMAZIONI MEMORIZZATI SU QUALSIASI SUPPORTO O QUALSIASI PARTE DI QUALSIASI PRODOTTO INVIATO A EIZO O I SUOI DISTRIBUTORI PER RIPARAZIONI.

EIZO E I SUOI DISTRIBUTORI NON OFFRONO ALCUNA GARANZIA ADDIZIONALE, IMPLICITA O ESPLICITA, RIGUARDO IL PRODOTTO E LA SUA QUALITÀ, PRESTAZIONI, VENDIBILITÀ O APPROPRIATEZZA PER QUALSIASI USO PARTICOLARE. IN NESSUN CASO EIZO O I DISTRIBUTORI EIZO AUTORIZZATI SARANNO RESPONSABILI PER QUALSIASI DANNO ACCIDENTALE, INDIRECTO, SPECIALE, CONSEGUENTE O DI QUALSIASI ALTRA NATURA (INCLUSI, SENZA LIMITI, DANNI PER PERDITA DI PROFITTI, INTERRUZIONE DELLE ATTIVITÀ, PERDITA DI INFORMAZIONI D’AFFARI O QUALSIASI ALTRA PERDITA PECUNIARIA) DERIVANTI DALL’USO O DALL’IMPOSSIBILITÀ DI USARE IL PRODOTTO O IN QUALSIASI RELAZIONE AL PRODOTTO, SIA SU BASE DI CONTRATTO, TORTO, NEGLIGENZA, STRETTA RESPONSABILITÀ O ALTRIMENTI, ANCHE SE EIZO O I DISTRIBUTORI EIZO AUTORIZZATI SONO STATI AVVERTITI DELLA POSSIBILITÀ DI TALI DANNI. QUESTA ESCLUSIONE INCLUDE ANCHE QUALSIASI RESPONSABILITÀ CHE POSSA INSORGERE DA RECLAMI DI TERZI CONTRO L’ACQUIRENTE ORIGINALE. L’ESSENZA DI QUESTO PROVVEDIMENTO È LIMITARE LA RESPONSABILITÀ POTENZIALE DI EIZO E DEI DISTRIBUTORI DERIVANTE DA QUESTA GARANZIA LIMITATA E/O DALLE VENDITE.

BEGRÄNSAD GARANTI

EIZO Corporation (nedan kallat "**EIZO**") och EIZOs auktoriserade distributörer (nedan kallade "**Distributörer**") garanterar i enlighet med villkoren i denna begränsade garanti (nedan kallad "**Garantin**") den ursprunglige köparen (nedan kallad den "**Ursprunglige köparen**") som köpte den i dokumentet specificerade produkten (nedan kallad "**Produkten**") från EIZO eller Distributörer, att EIZO eller Distributörer enligt eget gottfinnande kostnadsfritt antingen reparera eller byta ut den defekta Produkten om den Ursprunglige köparen inom Garantiperioden (definieras nedan) upptäcker att Produkten fungerar felaktigt eller skadas under normal användning av Produkten i enlighet med beskrivningen i bruksanvisningen (nedan kallad "**Bruksanvisning**").

Garantiperioden är begränsad till tre (3) år från datumet för Produktens inköp (häri kallad "**Garantiperioden**"). EIZO och Distributörer ska inte under några villkor ha något annat ansvar än vad som anges i denna garanti gällande Produkten i relation till den Ursprunglige köparen eller tredje part.

EIZO och dess leverantörer slutar lagerföra delar (utom designdelar) till produkten sju (7) år efter att delen i fråga slutar tillverkas. När skärmen repareras använder EIZO och distributörer reservdelar som uppfyller våra kvalitetsstandarder. Om enheten inte kan repareras på grund av skicket eller att en del inte finns i lager kan EIZO och dess leverantörer erbjuda sig att byta ut produkten mot en produkt med likvärdig prestanda istället för att reparera den.

Garantin är endast giltig i de länder där det finns Distributörer. Garantin begränsar inte några av den Ursprunglige köparens lagstadgade rättigheter.

Oavsett andra villkor i denna garanti ska inte EIZO Distributörer under några villkor ha något ansvar i något av de fall som beskrivs nedan:

- (a) När någon bristfällighet hos Produkten kan härledas till att ha uppstått vid frakt, modifiering, ändring, felaktigt handhavande, olycka, felaktig installation, katastrof, felaktigt underhåll och/eller felaktig reparation utförd av tredje part annan än EIZO och Distributörer.
- (b) Alla former av inkompatibilitet hos Produkten på grund av möjliga tekniska innovationer och/eller bestämmelser.
- (c) Alla försämringar av sensorn.
- (d) Alla försämringar av bildens prestanda beroende på förbrukningsdelar så som LCD-panel och/eller bakgrundsbelysning etc. (t.ex. ändringar i ljusstyrka, jämnhet i ljusstyrka, färg, färgjämnhet, defekta pixlar och/eller fast lysande pixlar etc.).
- (e) Alla defekter hos Produkten som orsakats av placering på en plats där den kan påverkas av kraftiga vibrationer eller stötar.
- (f) Alla defekter hos Produkten som orsakats av extern utrustning.
- (g) Alla defekter hos Produkten på vilken det ursprungliga serienumret har ändrats eller avlägsnats.
- (h) Alla produktfel som orsakas av vätska som läcker från batteriet.
- (i) All normal försämring av Produkten, speciellt förbrukningsartiklar, tillbehör och/eller yttre delar (t.ex. knappar, roterande delar, kablar, Bruksanvisningen etc.).
- (j) Varje deformation, missfärgning, skevhet och/eller rost av Produktens yttre inklusive ytan på LCD-panelen.

För att erhålla service under denna garanti måste den Ursprunglige köparen (med hänseende till risken för skada och/eller förlust under transport) leverera Produkten till närmaste Distributör med förebetalad frakt, i dess ursprungliga förpackning eller annan fullgod förpackning som ger likvärdigt skydd. Den Ursprunglige köparen måste kunna visa inköpsbevis för Produkten som klargör Produktens inköpsdatum vid begäran av garantiservice.

Garantiperioden för alla utbytta och/eller reparerade produkter under denna garanti skall upphöra vid utgången av den ursprungliga Garantiperioden.

EIZO ELLER DISTRIBUTÖRER ÄR INTE ANSVARIGA FÖR NÅGON FORM AV SKADA ELLER FÖRLUST AV DATA ELLER ANNAN INFORMATION SOM HAR LAGRATS I NÅGON FORM AV MEDIA ELLER ANNAN DEL AV NÅGON PRODUKT SOM HAR RETURNERATS TILL EIZO ELLER DISTRIBUTÖRER FÖR REPARATION.

EIZO OCH DISTRIBUTÖRERNA GARANTERAR INGET, UTTRYCKLIGEN ELLER UNDERFÖRSTÅTT, VAD BETRÄFFAR PRODUKTEN OCH DESS KVALITET, PRESTANDA, SÄLJBARHET ELLER LÄMPLIGHET FÖR NÅGON FORM AV SPECIELL ANVÄNDNING. UNDER INGA OMSTÄNDIGHETER SKALL EIZO ELLER DISTRIBUTÖRERNA HÅLLAS ANSVARIGA FÖR NÅGRA SOM HELST UNDERORDNADE, INDIREKTA, SPECIELLA, DÄRAV FÖLJANDE ELLER ÖVRIGA SKADOR (INKLUSIVE, UTAN BEGRÄNSNING TILL, SKADOR FÖR FÖRLUST AV INKOMST, AVBRUTEN AFFÄRSRÖRELSE, FÖRLUST AV AFFÄRSINFORMATION ELLER ANNAN SÄRSKILD FÖRLUST) SOM UPPSTÅTT SOM ETT RESULTAT AV ANVÄNDNING ELLER OFÖRMÅGA ATT ANVÄNDA PRODUKTEN ELLER I NÅGON FORM AV ANSLUTNING TILL PRODUKTERNA, VARE SIG DETTA GRUNDAS PÅ KONTRAKT, ÅTALBAR HANDLING, FÖRSUMLIGHET, ANSVARSSKYLDIGHET ELLER ANNAT, ÄVEN OM EIZO ELLER DISTRIBUTÖRERNA HAR INFORMERATS BETRÄFFANDE MÖJLIGHET ATT SÅDANA SKADOR FÖRELIGGER. DETTA UNDANTAG OMFATTAR ÄVEN ALL FORM AV ANSVARSSKYLDIGHET SOM KAN UPPSTÅ GENOM EN TREDJE PARTS ANSPRÅK GENTEMOT DEN URSPRUNGLIGE KÖPAREN. GRUNDBESTÅNDSDELEN I BESTÄMMELEN ÄR ATT BEGRÄNSA DET EVENTUELLA ANSVARSTAGANDET FÖR EIZO OCH DISTRIBUTÖRERNA SOM KAN UPPSTÅ GENOM DENNA BEGRÄNSADE GARANTI OCH/ELLER FÖRSÄLJNING.

ΠΕΡΙΟΡΙΣΜΕΝΗ ΕΓΓΥΗΣΗ

Η EIZO Corporation (στο εξής «**EIZO**») και οι διανομείς που εξουσιοδοτεί η EIZO (στο εξής «**Διανομείς**») παρέχουν εγγύηση, υποκειμένη και σύμφωνα με τους όρους της παρούσας περιορισμένης εγγύησης (στο εξής «**Εγγύηση**»), στον αρχικό αγοραστή (στο εξής «**Αρχικός Αγοραστής**») ο οποίος αγόρασε το προϊόν που καθορίζεται στο παρόν έγγραφο (στο εξής «**Προϊόν**») από την EIZO ή τους Διανομείς, η οποία εξασφαλίζει ότι η EIZO και οι Διανομείς, σύμφωνα με τη διακριτή ευχέρειά τους, είτε θα επισκευάσουν είτε θα αντικαταστήσουν το Προϊόν χωρίς χρέωση εάν ο Αρχικός Αγοραστής αντιληφθεί εντός της Περιόδου Εγγύησης (ορίζεται κατωτέρω) ότι το Προϊόν δυσλειτουργεί ή έχει υποστεί βλάβη κατά τη διάρκεια κανονικής χρήσης του Προϊόντος σύμφωνα με την περιγραφή στο εγχειρίδιο χρήσης που συνοδεύει το Προϊόν (στο εξής «**Εγχειρίδιο Χρήστη**»).

Η περίοδος της παρούσας Εγγύησης είναι τρία (3) έτη από την ημερομηνία αγοράς του Προϊόντος (στο εξής «**Περίοδος Εγγύησης**»). Η EIZO και οι Διανομείς δεν φέρουν καμία ευθύνη ή υποχρέωση όσον αφορά το Προϊόν σε σχέση με τον Αρχικό Αγοραστή ή οποιοδήποτε τρίτο μέρος, ούτε άλλη ευθύνη διαφορετική από αυτήν που παρέχεται στην παρούσα Εγγύηση.

Η EIZO και οι διανομείς της θα πάψουν να διατηρούν αποθέματα εξαρτημάτων (εκτός από τα εξαρτήματα σχεδιασμού) του προϊόντος μόλις περάσουν επτά (7) χρόνια αφότου διακοπεί η παραγωγή των εν λόγω εξαρτημάτων. Κατά την επισκευή της οθόνης, η EIZO και οι Διανομείς θα χρησιμοποιήσουν ανταλλακτικά επισκευής που συμμορφώνονται με τα πρότυπά μας για τη Διασφάλιση Ποιότητας. Αν δεν είναι εφικτή η επισκευή της μονάδας λόγω της κατάστασής της ή λόγω έλλειψης αποθεμάτων κάποιου σχετικού εξαρτήματος, η EIZO και οι διανομείς της ενδέχεται να σας προσφέρουν τη δυνατότητα αντικατάστασής της με προϊόν ισοδύναμων επιδόσεων αντί να την επισκευάσουν.

Η Εγγύηση ισχύει μόνο σε χώρες ή περιοχές όπου βρίσκονται οι Διανομείς. Η Εγγύηση δεν περιορίζει οποιαδήποτε νόμιμα δικαιώματα του Αρχικού Αγοραστή.

Λαμβανομένης υπόψη κάθε διάταξης της παρούσας Εγγύησης, η EIZO και οι Διανομείς δεν θα έχουν καμία απολύτως υποχρέωση σύμφωνα με την παρούσα Εγγύηση σε οποιαδήποτε από τις περιπτώσεις που διατυπώνονται κατωτέρω:

- (α) Τυχόν ελάττωμα του Προϊόντος που προκαλείται από ζημία κατά τη μεταφορά, τροποποίηση, αλλαγή, κατάχρηση, λανθασμένη χρήση, ατύχημα, λανθασμένη εγκατάσταση, καταστροφή, εσφαλμένη συντήρηση ή/και λανθασμένη επισκευή από τρίτο μέρος εκτός της EIZO και των Διανομέων,
- (β) Τυχόν ασυμβατότητα του Προϊόντος λόγω πιθανών τεχνικών καινοτομιών ή/και κανονισμών,
- (γ) Τυχόν επιδείνωση του αισθητήρα,
- (δ) Τυχόν επιδείνωση της απόδοσης οθόνης που προκαλείται από τη φθορά αναλώσιμων εξαρτημάτων όπως της οθόνης LCD ή/και του φωτός υποβάθρου, κτλ. (π.χ. αλλαγές στη φωτεινότητα, αλλαγές στην ομοιομορφία φωτεινότητας, αλλαγές στο χρώμα, αλλαγές στην ομοιομορφία χρώματος, ελαττώματα σε pixel περιλαμβανομένων των καμένων pixel, κτλ.),
- (ε) Τυχόν ελάττωμα του Προϊόντος που οφείλεται στην τοποθέτησή του σε θέση όπου μπορεί να επηρεαστεί από ισχυρούς κραδασμούς ή κρούσεις,
- (στ) Τυχόν ελάττωμα του Προϊόντος που προκαλείται από εξωτερικό εξοπλισμό,
- (ζ) Τυχόν ελάττωμα του Προϊόντος στο οποίο έχει τροποποιηθεί ή αφαιρεθεί ο γνήσιος αριθμός σειράς,
- (η) Τυχόν ελάττωμα του Προϊόντος που προκαλείται από διαρροή υγρού από την μπαταρία,
- (θ) Τυχόν φυσιολογική φθορά του προϊόντος, ιδιαίτερα αυτής των αναλώσιμων, των αξεσουάρ ή/και των προσαρτημάτων (π.χ. κουμπιά, περιστρεφόμενα μέρη, καλώδια, Εγχειρίδιο Χρήστη, κτλ.), και
- (ι) Τυχόν παραμόρφωση, αποχρωματισμό, διαστρέβλωση ή/και σκουριά του εξωτερικού μέρους του προϊόντος, περιλαμβανομένης της επιφάνειας της οθόνης LCD.

Ο Αρχικός Αγοραστής για να δικαιούται υπηρεσίες επισκευής σύμφωνα με την Εγγύηση, θα πρέπει να παραδώσει το Προϊόν, με πληρωμένα τα μεταφορικά έξοδα, στην αρχική του συσκευασία ή σε άλλη επαρκή συσκευασία με ισότιμο βαθμό προστασίας, αναλαμβάνοντας τον κίνδυνο βλάβης ή/και απώλειας κατά τη μεταφορά, στον τοπικό Διανομέα. Ο Αρχικός Αγοραστής όταν ζητά υπηρεσίες επισκευής σύμφωνα με την Εγγύηση, θα πρέπει να προσκομίζει την απόδειξη αγοράς του Προϊόντος και την ημερομηνία της αγοράς.

Η Περίοδος Εγγύησης για οποιοδήποτε αντικατεστημένο ή/και επισκευασμένο προϊόν σύμφωνα με την παρούσα Εγγύηση λήγει στο τέλος της αρχικής Περιόδου Εγγύησης.

Η EIZO Ή ΟΙ ΔΙΑΝΟΜΕΙΣ ΔΕΝ ΕΥΘΥΝΟΝΤΑΙ ΓΙΑ ΟΠΟΙΑΔΗΠΟΤΕ ΒΛΑΒΗ Ή ΑΠΩΛΕΙΑ ΔΕΔΟΜΕΝΩΝ Ή ΑΛΛΩΝ ΠΛΗΡΟΦΟΡΙΩΝ ΠΟΥ ΑΠΟΘΗΚΕΥΟΝΤΑΙ ΣΕ ΟΠΟΙΟΔΗΠΟΤΕ ΜΕΣΟ Ή ΟΠΟΙΟΔΗΠΟΤΕ ΑΛΛΟ ΜΕΡΟΣ ΣΕ ΟΠΟΙΟΔΗΠΟΤΕ ΠΡΟΪΟΝ ΠΟΥ ΕΠΙΣΤΡΕΦΕΤΑΙ ΣΤΗΝ EIZO Ή ΣΕ ΔΙΑΝΟΜΕΑ ΓΙΑ ΕΠΙΣΚΕΥΗ.

Η EIZO ΚΑΙ ΟΙ ΔΙΑΝΟΜΕΙΣ ΔΕΝ ΠΑΡΕΧΟΥΝ ΚΑΜΙΑ ΠΕΡΑΙΤΕΡΩ ΕΓΓΥΗΣΗ, ΡΗΤΗ Ή ΣΥΝΕΠΑΓΟΜΕΝΗ, ΟΣΟΝ ΑΦΟΡΑ ΤΟ ΠΡΟΪΟΝ ΚΑΙ ΤΗΝ ΠΟΙΟΤΗΤΑ, ΤΗΝ ΑΠΟΔΟΣΗ, ΤΗΝ ΕΜΠΟΡΕΥΣΙΜΟΤΗΤΑ Ή ΤΗΝ ΚΑΤΑΛΛΗΛΟΤΗΤΑ ΤΟΥ ΓΙΑ ΟΠΟΙΑΔΗΠΟΤΕ ΣΥΓΚΕΚΡΙΜΕΝΗ ΧΡΗΣΗ. ΣΕ ΚΑΜΙΑ ΠΕΡΙΠΤΩΣΗ Η EIZO Ή ΟΙ ΔΙΑΝΟΜΕΙΣ ΔΕΝ ΘΑ ΕΥΘΥΝΟΝΤΑΙ ΓΙΑ ΚΑΜΙΑ ΑΠΟΛΥΤΩΣ ΤΥΧΑΙΑ, ΕΜΜΕΣΗ, ΕΙΔΙΚΗ, ΣΥΝΕΠΑΓΟΜΕΝΗ Ή ΑΛΛΗ ΒΛΑΒΗ (ΠΕΡΙΛΑΜΒΑΝΟΜΕΝΩΝ, ΜΕΤΑΞΥ ΑΛΛΩΝ, ΒΛΑΒΩΝ Ή ΑΠΩΛΕΙΑΣ ΚΕΡΔΩΝ, ΔΙΑΚΟΠΗΣ ΕΠΙΧΕΙΡΗΜΑΤΙΚΩΝ ΔΡΑΣΤΗΡΙΟΤΗΤΩΝ, ΑΠΩΛΕΙΑΣ ΕΠΙΧΕΙΡΗΜΑΤΙΚΩΝ ΠΛΗΡΟΦΟΡΙΩΝ Ή ΤΥΧΟΝ ΑΛΛΗΣ ΧΡΗΜΑΤΙΚΗΣ ΑΠΩΛΕΙΑΣ) ΠΟΥ ΠΡΟΚΥΠΤΕΙ ΑΠΟ ΤΗ ΧΡΗΣΗ Ή ΤΗΝ ΑΝΙΚΑΝΟΤΗΤΑ ΧΡΗΣΗΣ ΤΟΥ ΠΡΟΪΟΝΤΟΣ Ή ΤΥΧΟΝ ΑΛΛΗΣ ΣΥΝΔΕΣΗΣ ΜΕ ΤΟ ΠΡΟΪΟΝ, ΕΙΤΕ ΒΑΣΙΖΕΤΑΙ ΣΕ ΣΥΜΒΟΛΑΙΟ, ΒΛΑΒΗ, ΑΜΕΛΕΙΑ, ΑΥΣΤΗΡΗ ΕΥΘΥΝΗ Ή ΕΙΔΑΛΛΩΣ, ΑΚΟΜΗ ΚΙ ΕΑΝ Η EIZO Ή ΟΙ ΔΙΑΝΟΜΕΙΣ ΕΝΗΜΕΡΩΘΟΥΝ ΓΙΑ ΤΗΝ ΠΙΘΑΝΟΤΗΤΑ ΤΕΤΟΙΩΝ ΖΗΜΙΩΝ. Η ΕΞΑΙΡΕΣΗ ΑΥΤΗ ΠΕΡΙΛΑΜΒΑΝΕΙ ΕΠΙΣΗΣ ΟΠΟΙΑΔΗΠΟΤΕ ΕΥΘΥΝΗ ΕΝΔΕΧΕΤΑΙ ΝΑ ΠΡΟΚΥΨΕΙ ΑΠΟ ΑΞΙΩΣΕΙΣ ΤΡΙΤΟΥ ΜΕΡΟΥΣ ΚΑΤΑ ΤΟΥ ΑΡΧΙΚΟΥ ΑΓΟΡΑΣΤΗ. Η ΟΥΣΙΑ ΤΟΥ ΟΡΟΥ ΑΥΤΟΥ ΕΙΝΑΙ ΝΑ ΠΕΡΙΟΡΙΣΕΙ ΤΗΝ ΠΙΘΑΝΗ ΕΥΘΥΝΗ ΤΗΣ EIZO ΚΑΙ ΤΩΝ ΔΙΑΝΟΜΕΩΝ ΠΟΥ ΠΡΟΚΥΠΤΕΙ ΑΠΟ ΤΗΝ ΠΑΡΟΥΣΑ ΕΓΓΥΗΣΗ Ή/ΚΑΙ ΤΙΣ ΠΩΛΗΣΕΙΣ.

ОГРАНИЧЕННАЯ ГАРАНТИЯ

EIZO Corporation (называемая в дальнейшем “EIZO”) и авторизованные EIZO дистрибуторы (называемые в дальнейшем “Дистрибуторы”) гарантируют, в соответствии с условиями и пунктами этой ограниченной гарантии (называемой в дальнейшем “Гарантия”), первичному покупателю (называемому в дальнейшем “Первоначальный покупатель”), который приобрел у EIZO или Дистрибуторов продукт, указанный в этом документе (называемый в дальнейшем “Продукт”), что EIZO или Дистрибуторы на свое усмотрение либо бесплатно отремонтируют, либо бесплатно заменят Продукт, если Первоначальный покупатель признает в пределах Гарантийного срока (определенного ниже), что Продукт неисправен или он поврежден процессе нормального использования продукта в соответствии с описанием в инструкции по эксплуатации, прилагаемой к Продукту (называемой в дальнейшем “Руководство пользователя”).

Гарантийный период ограничен сроком три (3) года от даты приобретения Продукта (называемый в дальнейшем “Гарантийный период”). EIZO и Дистрибуторы не несут никакой ответственности и не берут обязательств относительно Продукта по отношению к Первоначальному покупателю или по отношению к любым третьим сторонам, кроме обязательств, оговоренных в этой Гарантии.

Компания EIZO и ее дистрибуторы хранят детали изделия (за исключением деталей внешней конструкции) не более семи (7) лет после прекращения его выпуска. В случае ремонта монитора EIZO и Дистрибуторы будут использовать запчасти, которые соответствуют нашим стандартам QC (контроль качества). Если устройство невозможно отремонтировать из-за его состояния или отсутствия нужной детали, то вместо ремонта компания EIZO и ее дистрибуторы могут предлагать замену неисправного устройства на устройство с аналогичными характеристиками.

Гарантия действительна только в странах или регионах, где расположены Дистрибуторы. Гарантия не ограничивает никакие законные права Первоначального покупателя.

Несмотря на другие условия этой Гарантии EIZO и Дистрибуторы не несут никаких обязательств согласно этой Гарантии в любом из перечисленных ниже случаев:

- (а) Любые дефекты Продукта, вызванные повреждениями при перевозке, модификацией, изменением, неправильным обращением, неправильным использованием, авариями, неправильной установкой, стихийными бедствиями, неправильным уходом и/или неправильным ремонтом третьей стороной, отличной от EIZO или Дистрибуторов;
- (б) Любые несовместимости Продукта из-за технических усовершенствований и/или изменения технических норм;
- (в) Любое повреждение датчика;
- (г) Любые ухудшения работы дисплея, вызванные изнашиванием невосстановимых частей, таких как панель ЖКД и/или подсветка и т.д. (например, изменение в яркости, изменение в равномерности яркости, изменение в цветности, изменение в равномерности цветности, изменение в пикселях, включая выгоревшие пиксели и т.д.);
- (д) Любые дефекты Продукта, возникшие вследствие его размещения в месте, где Продукт может быть подвержен сильной вибрации или ударам;
- (е) Любые дефекты Продукта, вызванные внешним оборудованием;
- (ж) Любые дефекты Продукта, при которых оригинальный серийный номер был изменен или удален;
- (з) Любые дефекты Продукта, вызванные протеканием батареек;
- (и) Любые естественные ухудшения продукта, в частности, вызванные износом расходных частей, принадлежностей и/или приспособлений (например, кнопок, вращающихся частей, кабелей, Руководства пользователя и т.д.); и
- (j) Любые деформации, изменения цвета, коробления и/или коррозия внешней поверхности продукта, включая поверхность панели ЖКД.

Чтобы получить техническое обслуживание в рамках Гарантии, Первоначальный покупатель должен доставить Продукт местному Дистрибутору, оплатив перевозку, в его оригинальной упаковке или в другой соответствующей упаковке, обеспечивающей равноценную степень защиты, принимая во внимание риск повреждения и/или утерю при транспортировке. При запросе технического обслуживания в рамках Гарантии Первоначальный покупатель должен предоставить свидетельство покупки продукта и даты покупки.

Гарантийный период для любого замененного и/или отремонтированного продукта в рамках Гарантии истекает в конце завершения срока действия оригинального Гарантийного периода.

EIZO или ДИСТРИБУТОРЫ НЕ НЕСУТ ОТВЕТСТВЕННОСТИ ЗА ЛЮБЫЕ ПОВРЕЖДЕНИЯ ИЛИ УТЕРЮ ДАННЫХ ИЛИ ДРУГОЙ ИНФОРМАЦИИ, ХРАНЯЩИХСЯ НА КАКИХ-ЛИБО НОСИТЕЛЯХ ИНФОРМАЦИИ ИЛИ НА ЛЮБЫХ ДРУГИХ ЧАСТЯХ ПРОДУКТА, КОТОРЫЙ ВОЗВРАЩЕН EIZO или ДИСТРИБУТОРАМ ДЛЯ РЕМОНТА.

EIZO и ДИСТРИБУТОРЫ НЕ ДАЮТ НИКАКОЙ ДАЛЬНЕЙШЕЙ ГАРАНТИИ, ВЫРАЖЕННОЙ ИЛИ ПОДРАЗУМЕВАЕМОЙ, ОТНОСИТЕЛЬНО ПРОДУКТА И ЕГО КАЧЕСТВА, ТЕХНИЧЕСКИХ ХАРАКТЕРИСТИК, ТОВАРНОСТИ ИЛИ СООТВЕТСТВИЯ ДЛЯ КАКОГО-ЛИБО ОПРЕДЕЛЕННОГО ИСПОЛЬЗОВАНИЯ. НИ ПРИ КАКИХ УСЛОВИЯХ EIZO или ДИСТРИБУТОРЫ НЕ НЕСУТ ОТВЕТСТВЕННОСТИ ЗА ЛЮБОЙ СЛУЧАЙНЫЙ, КОСВЕННЫЙ, СПЕЦИАЛЬНЫЙ, ПОБОЧНЫЙ ИЛИ ИНОЙ УЩЕРБ (ВКЛЮЧАЯ, БЕЗ ОГРАНИЧЕНИЙ, УЩЕРБ ИЗ-ЗА НЕПОЛУЧЕННОЙ ПРИБЫЛИ, ПРЕРЫВАНИЯ БИЗНЕСА, ПОТЕРИ КОММЕРЧЕСКОЙ ИНФОРМАЦИИ ИЛИ ЛЮБЫЕ ДРУГИЕ ФИНАНСОВЫЕ ПОТЕРИ), ВОЗНИКШИЙ ИЗ-ЗА ИСПОЛЬЗОВАНИЯ ИЛИ НЕВОЗМОЖНОСТИ ИСПОЛЬЗОВАТЬ ПРОДУКТ ИЛИ В ЛЮБОЙ ДРУГОЙ СВЯЗИ С ПРОДУКТОМ, ЛИБО ОСНОВАННЫЙ НА КОНТРАКТНЫХ ОТНОШЕНИЯХ, ГРАЖДАНСКИХ ПРАВОНАРУШЕНИЯХ, НЕБРЕЖНОСТИ, ПРИЧИНЕНИЯ УЩЕРБА ТРЕТЬЕЙ СТОРОНЕ ИЛИ ЧЕМ-ЛИБО ЕЩЕ, ДАЖЕ ЕСЛИ EIZO или ДИСТРИБУТОРЫ БЫЛИ УВЕДОМЛЕННЫ О ВОЗМОЖНОСТИ ТАКОГО УЩЕРБА. ЭТО ИСКЛЮЧЕНИЕ ТАКЖЕ ВКЛЮЧАЕТ ЛЮБЫЕ ОБЯЗАТЕЛЬСТВА, КОТОРЫЕ МОГУТ ВОЗНИКНУТЬ В РЕЗУЛЬТАТЕ ТРЕБОВАНИЙ ТРЕТЬЕЙ СТОРОНЫ В ОТНОШЕНИИ ПЕРВОНАЧАЛЬНОГО ПОКУПАТЕЛЯ. СУЩЕСТВОМ ЭТОГО ПОЛОЖЕНИЯ ЯВЛЯЕТСЯ ОГРАНИЧЕНИЕ ПОТЕНЦИАЛЬНОЙ ОТВЕТСТВЕННОСТИ EIZO и ДИСТРИБУТОРОВ, ВОЗНИКАЮЩЕЙ ИЗ-ЗА ЭТОЙ ОГРАНИЧЕННОЙ ГАРАНТИИ И/ИЛИ ПРОДАЖ.

有限保证责任书

EIZO Corporation（以下简称“EIZO”）和EIZO授权的经销商（以下简称“经销商”），接受并依照本有限保证责任书（以下简称“保证书”）之条款，向从EIZO和经销商购买本文中规定产品（以下简称“产品”）的原买方（以下称“原买方”）提供保证：在保证期内（规定如下），如果原买方发现按本产品所附使用说明书（以下简称“用户手册”）所述方式正常使用本产品过程中，本产品出现故障或损坏，EIZO和经销商根据其独立的判断免费修理或更换该产品。

本保证期限定为本产品自购买本产品之日起的三（3）年（以下简称“保证期限”）。EIZO和经销商将不向原买方或任何第三方承担本保证书所规定之外的与本产品有关任何责任或义务。

本产品的任何部件停产七（7）年后，EIZO和经销商将不再保留或保管任何这类部件（设计零件除外）。维修显示器时，EIZO与经销商将使用符合我方质量控制标准的替换零件。若由于自身条件或缺少相关零件而不能修理设备，EIZO和经销商可提供性能相同的更换产品，而无需维修。

本保证书仅对于设有经销商的国家或地区有效。本保证书并不限定原买方的任何法律权利。

无论本保证书的任何其他条款如何规定，对于任何下列情况之一，EIZO和经销商将不承担本保证书规定责任：

- (a) 由于运输损害、改装、改动、滥用、误用、意外事故、错误安装、灾害、维护不善和 / 或由除EIZO和经销商以外的第三方进行不适当的修理造成本产品的任何故障。
- (b) 由于可能发生的技术变更和 / 或调整造成本产品的任何不兼容性。
- (c) 传感器的任何劣化。
- (d) 由于诸如液晶显示屏（LCD）和 / 或背灯等消耗品部件的老化造成的任何显示性能低劣（如亮度变化、亮度均一性变化、色彩变化、色彩均一性变化、如烧伤像素等像素缺陷）。
- (e) 将产品放置在可能受强烈振动或冲击影响的位置，可能会导致产品出现缺陷。
- (f) 因外部设备造成本产品的任何故障。
- (g) 因本产品的原序号被改变或消除造成本产品的任何故障。
- (h) 因电池液体泄漏造成本产品的任何故障。
- (i) 本产品的任何正常老化，尤其是消耗品、附件和 / 或附加装置（如按钮、旋转部件、电缆、用户手册等）、以及
- (j) 本产品表面包括液晶显示屏（LCD）表面的任何变形、变色、翘曲和 / 或生锈。

为了获得本保证书规定的服务，原买方必须使用原包装或其他具有同等保护程度的适当包装将本产品运送到当地的经销商，并且预付运费，承担运输中的损坏和 / 或损失的风险。要求提供本保证书规定的服务时，原买方必须提交购买本产品和标明此购买日期的证明。

按本保证书规定进行了更换和 / 或修理的任何产品的保证期限，将在原保证期限结束时终止。

在返回给EIZO和经销商进行修理后，任何产品的任何媒体或任何部件中储存的数据或其他信息发生任何损坏或损失，对此EIZO和经销商将不承担责任。

对于本产品及其质量、性能、可销售性以及对于特殊用途的适合性，EIZO和经销商不提供其他任何明示或暗示的保证。因使用本产品或无法使用本产品或因与本产品有任何关系（无论是否根据合同）而造成：任何附带的、间接的、特殊的、随之发生的或其他的损害（包括但不限于：利润损失、业务中断、业务信息丢失或其他任何金钱损失）以及侵权行为、过失、严格赔偿责任或其他责任，即使已经向EIZO和经销商提出了发生这些损害的可能性，对此EIZO和经销商概不承担责任。本免责条款还包括因第三方向原买方提出索赔而可能发生的任何责任。本条款的本质是限定由于本有限保证责任书和 / 或销售本产品所发生的EIZO和经销商的潜在责任。

제한 보증

EIZO Corporation(이후 “EIZO”라고 함) 및 EIZO가 승인한 유통업체(이후 “유통업체”라고 함)는 제한 보증(이후 “보증”이라고 함) 약관에 따라 EIZO 또는 유통업체로부터 이 문서에 지정된 제품(이후 “제품”이라고 함)을 구입한 최초 구매자(이후 “최초 구매자”라고 함)에게 EIZO 및 유통업체는 고유 권한에 의거하여 최초 구매자가 보증 기간(아래 정의) 내에 제품에 부착된 사용 설명서(이후 “사용 설명서”라고 함)의 설명에 따라 제품을 정상적으로 사용하는 과정에서 제품이 고장났거나 손상된 것을 알게된 경우 무료로 교체 또는 수리해야 합니다.

이 보증 기간은 제품 구입일로부터 3년입니다(이후 “보증 기간”이라고 함). EIZO 및 유통업체는 본 보증 하에 제공된 내용을 제외하고 최초 구매자 또는 제 3자와 관련된 제품에 대해 어떠한 책임도 없습니다.

EIZO 및 공급업체는 해당 부품 생산 종료 후 7년의 기간 만료에 따라서 제품의 부품에 대한 유지 또는 공급을 중단합니다(디자인 부품은 제외). 모니터 수리 시 EIZO 및 유통업체는 당사의 QC 표준을 준수하는 재생 부품을 사용합니다. 만일 제품의 상태에 따라서 또는 해당 부품의 재고가 없어서 수리를 하지 못하는 경우 EIZO 및 공급업체는 수리를 대신하여 동등한 성능을 지닌 제품으로 교체를 제공할 수 있습니다.

보증은 유통업체가 위치한 국가 또는 지역에서만 유효합니다. 보증은 최초 구매자의 법적 권한을 제한하지 않습니다.

본 보증의 다른 규정에도 불구하고, EIZO 및 유통업체는 아래 규정된 경우에 대해서는 본 보증 하에서 보증 의무가 없습니다.

- (a) EIZO 및 유통업체 이외 제 3자에 의한 화물 운송 피해, 개조, 변경, 남용, 오용, 사고, 부적절한 설치, 재난, 잘못된 유지보수 및 / 또는 부적절한 수리로 인해 발생하는 제품 결함;
- (b) 가능한 기술 혁신 및 / 또는 규정으로 인한 제품의 비호환성;
- (c) 센서 품질 불량;
- (d) LCD 패널 및 / 또는 백라이트 등과 같이 확장 가능 부품의 품질 불량으로 인한 디스플레이 성능 저하. (예: 밝기 변화, 밝기 일관성 변화, 컬러 변화, 컬러 일관성 변화, 픽셀 번짐 등을 포함한 픽셀 결함.);
- (e) 강한 진동 또는 충격에 의해 영향 받을 수 있는 장소에 배치함으로써 발생하는 제품 결함;
- (f) 외부 장비에 의해 발생하는 제품 결함;
- (g) 최초 일련 번호를 변경하거나 제거한 제품의 결함;
- (h) 배터리에 누출로 인해 발생하는 제품 결함;
- (i) 특히 소모품, 액세서리 및 / 또는 부착장치(예: 버튼, 회전 부품, 케이블, 사용 설명서 등)를 포함하여 제품의 정상적인 성능 저하; 및
- (j) LCD 패널 표면을 포함하여 제품 외관의 변형, 변색, 휨 및 / 또는 녹 발생.

보증 하에서 서비스를 받으려면 최초 구매자가 운송 중 손상 및 / 또는 손실 위험을 고려하여 최초 포장 또는 동등한 보호 수준을 제공하는 기타 적절한 포장에 제품을 포함하여 선불 운임으로 가까운 유통업체에 보내야 합니다. 최초 구매자는 보증 하에서 서비스 요청 시 제품 구입 및 이러한 구입 날짜 증명서를 제출해야 합니다.

본 보증 하의 어떠한 교체 및 / 또는 수리 제품에 대한 보증 기간도 최초 보증 기간 종료 시 만료됩니다.

EIZO 또는 유통업체는 수리를 위해 EIZO 또는 유통업체에 반환된 미디어 또는 제품의 부품에 보관된 데이터 또는 기타 정보의 손상 또는 분실에 대해 책임을 지지 않습니다.

EIZO 및 유통업체는 특정 용도에 대한 제품 및 품질, 성능, 상품성 또는 적합성과 관련하여 명시적 또는 암묵적으로 추가 보증을 하지 않습니다. 어떠한 경우에도 EIZO 또는 유통업체는 제품 또는 제품과 관련하여 사용으로부터 발생하거나 사용 불능으로 인해 발생하는 실수, 간접적, 특별한, 결과적 또는 기타 어떠한 손상(수익 손실 피해, 사업 중단, 사업 정보 손실 또는 기타 금전상의 손실 포함, 이에 국한되지 않음)에 대해, 계약, 불법 행위, 무시, 엄격한 법적 책임 또는 EIZO 또는 유통업체가 이러한 피해 가능성에 대해 조언한 경우에도 책임을 지지 않습니다. 또한 이 예외 규정에는 최초 구매자에 대한 제 3자 클레임으로부터 발생할 수 있는 어떠한 법적 책임도 포함됩니다. 본 규정의 핵심은 이 제한 보증 및 / 또는 판매로 인해 발생하는 EIZO 및 유통업체의 잠재적 법적 책임을 제한하는 것입니다.

Recycling Information

Recycling Information

This product, when disposed of, is supposed to be collected and recycled according to your country's legislation to reduce environmental burden. When you dispose of this product, please contact a distributor or an affiliate in your country.

The contact addressees are listed on the EIZO website below.

www.eizoglobal.com

For recycling information for customers in Switzerland, please refer to the following website.

www.swico.ch

Informationen zum Thema Recycling

Dieses Produkt muss gemäß den Vorschriften Ihres Landes zur Entlastung der Umwelt recyclet werden. Wenden Sie sich bei der Entsorgung dieses Produkts an einen Verteiler oder eine Tochtergesellschaft in Ihrem Land.

Die Adressen zur Kontaktaufnahme sind auf der unten angegebenen Website von EIZO aufgeführt.

www.eizoglobal.com

Kunden in der Schweiz entnehmen Informationen zum Recycling der folgenden Website:

www.swico.ch

Informations sur le recyclage

Ce produit doit être jeté aux points de collecte prévus à cet effet et recyclé conformément à la législation de votre pays, afin de réduire l'impact sur l'environnement. Lorsque vous jetez ce produit, veuillez contacter un distributeur ou une société affiliée de votre pays.

Les adresses des distributeurs sont répertoriées sur le site Web EIZO ci-dessous.

www.eizoglobal.com

Pour les clients en Suisse, veuillez consulter le site Web suivant afin d'obtenir des informations sur le recyclage.

www.swico.ch

Información sobre reciclaje

Este producto debe desecharse y reciclarse según la legislación del país para reducir el impacto medioambiental.

Cuando desee deshacerse de este producto, póngase en contacto con un distribuidor o una filial de su país.

Encontrará las direcciones de contacto en el sitio web de EIZO que se indica a continuación.

www.eizoglobal.com

Informazioni sul riciclaggio

Per lo smaltimento e il riciclaggio del presente prodotto, attenersi alle normative vigenti nel proprio paese per ridurre l'impatto ambientale. Per lo smaltimento, rivolgersi ad un distributore o un affiliato presenti nel proprio paese.

Gli indirizzi sono elencati nel sito Web EIZO riportato di seguito.

www.eizoglobal.com

Per informazioni sul riciclaggio per i clienti in Svizzera, consultare il sito Web riportato di seguito.

www.swico.ch

Återvinningsinformation

När denna produkt kasseras ska den hanteras och återvinnas enligt landets föreskrifter för att reducera miljöpåverkan.

När du kasserar produkten ska du kontakta en distributör eller representant i ditt land.

Kontaktadresserna listas på EIZO-webbplatsen nedan.

www.eizoglobal.com

Πληροφορίες ανακύκλωσης

Το προϊόν αυτό, όταν απορρίπτεται, πρέπει να συλλέγεται και να ανακυκλώνεται σύμφωνα με τη νομοθεσία της χώρας σας έτσι ώστε να μην επιβαρύνει το περιβάλλον. Για να απορρίψετε το προϊόν, επικοινωνήστε με έναν αντιπρόσωπο ή μια θυγατρική εταιρεία στη χώρα σας.

Οι διευθύνσεις επικοινωνίας αναγράφονται στην τοποθεσία web της EIZO παρακάτω.

www.eizoglobal.com

Сведения по утилизации

По истечении срока службы данного продукта его следует принести на сборный пункт и утилизировать в соответствии с действующими предписаниями в вашей стране, чтобы уменьшить вредное воздействие на окружающую среду. Прежде чем выбросить данный продукт, обратитесь к дистрибьютору или в местное представительство компании в вашей стране.

Контактные адреса можно найти на веб-узле EIZO.

www.eizoglobal.com

Informatie over recycling

Wanneer u dit product wilt weggooien, moet het uit milieu-overwegingen worden verzameld en gerecycled volgens de betreffende wetgeving van uw land. Wanneer u dit product wilt weggooien, moet u contact opnemen met een distributeur of een partner in uw land.

De contactadressen worden vermeld op de volgende EIZO-website.

www.eizoglobal.com

Informação sobre reciclagem

Este produto, quando o deitar fora, deve ser recolhido e reciclado de acordo com a legislação do seu país para reduzir a poluição. Quando deitar fora este produto, contacte um distribuidor ou uma filial no seu país.

Os endereços de contacto estão listados no website do EIZO, abaixo.

www.eizoglobal.com

Oplysninger om genbrug

Denne produkt forventes ved bortskaffelse at blive indsamlet og genbrugt i overensstemmelse med lovgivningen i dit land for at reducere belastningen af miljøet. Når du bortskaffer denne produkt, skal du kontakte en distributør eller et tilknyttet selskab i dit land.

Adresserne på kontaktpersonerne er angivet på EIZO's websted nedenfor.

www.eizoglobal.com

Kierrätystä koskevia tietoja

Tuote tulee hävittää kierrättämällä maan lainsäädännön mukaisesti ympäristön kuormittumisen vähentämiseksi. Kun hävität tuotteen, ota yhteyttä jälleenmyyjään tai tytäryhtiöön maassasi.

Yhteystiedot löytyvät EIZOn Internet-sivustolta.

www.eizoglobal.com

Wykorzystanie surowców wtórnych

Ten produkt po zużyciu powinien być zbierany i przetwarzany zgodnie z krajowymi przepisami dotyczącymi ochrony środowiska. Wyrzucając ten produkt, należy skontaktować się z lokalnym dystrybutorem lub partnerem. Adresy kontaktowe można znaleźć we wskazanej poniżej witrynie internetowej firmy EIZO.

www.eizoglobal.com

Informace o recyklaci

Při likvidaci produktu musí být produkt vyzvednut a recyklován podle zákonů příslušné země, aby nedocházelo k zatěžování životního prostředí. Zbavujete-li se produktu, kontaktujte distributora nebo pobočku ve své zemi. Kontaktní adresy jsou uvedeny na následující webové stránce společnosti EIZO.

www.eizoglobal.com

Ringlussevõtu alane teave

Keskkonnakoormuse vähendamiseks tuleks kasutatud tooted kokku koguda ja võtta ringlusse vastavalt teie riigi seadustele. Kui kõrvaldate käesoleva toote, võtke palun ühendust turustaja või filiaaliga oma riigis.

Kontaktisikud on toodud EIZO veebilehel järgmisel aadressil:

www.eizoglobal.com

Újrahasznosítási információ

Jelen terméket, amikor eldobjuk, az illető ország törvényei alapján kell összegyűjteni és újrahasznosítani, hogy csökkentjük a környezet terhelését. Amikor ezt a terméket eldobja, kérjük lépjen kapcsolatba egy országon belüli forgalmazóval vagy társvállalkozással.

A kapcsolat címei az EIZO alábbi weboldalán található felsorolva:

www.eizoglobal.com

Podatki o recikliranju

Ob koncu uporabe odslužen izdelek izročite na zbirno mesto za recikliranje v skladu z okoljevarstveno zakonodajo vaše države. Prosimo, da se pri odstranjevanju izdelka obrnete na lokalnega distributerja ali podružnico.

Kontaktne naslovi so objavljeni na spodaj navedenih spletnih straneh EIZO:

www.eizoglobal.com

Informácie o recyklácii

Pri likvidácii musí byť tento výrobok recyklovaný v súlade s legislatívou vašej krajiny, aby sa znížilo zaťaženie životného prostredia. Keď sa chcete zbaviť tohto výrobku, kontaktujte prosím distribútora alebo pobočku vo vašej krajine.

Zoznam kontaktných adries je uvedený na nasledovnej webovej stránke firmy EIZO:

www.eizoglobal.com

Pārstrādes informācija

Utilizējot šo produktu, tā savākšana un pārstrāde veicama atbilstoši jūsu valsts likumdošanas prasībām attiecībā uz slodzes uz vidi samazināšanu. Lai veiktu šī produkta utilizāciju, sazinieties ar izplatītāju vai pārstāvniecību jūsu valstī. Kontaktadresses ir norādītas zemāk minētajā EIZO tīmekļa vietnē.

www.eizoglobal.com

Informacija apie gražinamąjį perdirbimą

Šalinant (išmetant) šiuos gaminius juos reikia surinkti ir perdirbti gražinamuoju būdu pagal jūsų šalies teisės aktus, siekiant sumažinti aplinkos teršimą. Kai reikia išmesti šį gaminį, kreipkitės į jūsų šalyje veikiančią gaminių pardavimo atstovybę arba jos filialą.

Kontaktiniai adresatai nurodyti EIZO interneto svetainėje.

www.eizoglobal.com

Информация относительно рециклиране

При изхвърлянето на този продукт се предлага събирането и рециклирането му съобразно законите на вашата страна за да се намали замърсяването на околната среда. Когато искате да се освободите от този продукт, моля свържете се с търговския му представител или със съответните органи отговарящи за това във вашата страна.

Данните за връзка с нас са описани на следния Интернет сайт на EIZO:

www.eizoglobal.com

Informație referitoare la reciclare

Acest produs, când debarasat, trebuie colectat și reciclat conform legislației țării respective ca să reducem sarcina mediului. Când se debarasează de acest produs, vă rugăm să contactați un distribuitor sau un afiliat al țării respective. Adresele de contact le găsiți pe pagina de web al EIZO:

www.eizoglobal.com

معلومات عن اعادة التدوير

عند التخلص من هذا المنتج، من الضروري تجميعه واعادة تدويره وفقاً للقوانين المتبعة في بلدك لتقليل العبء المسلط على البيئة. عندما تتخلص من هذا المنتج، يرجى الاتصال بموزع أو طرف منتسب إليه في بلدك. عناوين الاتصال مدرجة في موقع ايزو EIZO ادناه على شبكة الانترنت.

www.eizoglobal.com

Gerı Dönüşüm Bilgisi

Bu ürünün, atılacağı zaman, ülkenizin çevre kirliliğinin azaltılması konusundaki mevzuatına göre toplanması ve yeniden değerlendirilmesi gerekmektedir. Ürünü atacağınız zaman lütfen ülkenizdeki bir distribütör veya ilgili kuruluşla temasa geçiniz.

İrtibat adresleri aşağıdaki EIZO web sitesinde verilmiştir.

www.eizoglobal.com

China Measures for RoHS Compliance in ChinaRoHS

关于电器电子产品有害物质限制使用标识



本标识根据「电器电子产品有害物质限制使用管理办法」，适用于在中华人民共和国销售的电器电子产品。标识中央的数字为环保使用期限的年数。只要您遵守该产品相关的安全及使用注意事项，在自制造日起算的年限内，不会产生对环境污染或人体及财产的影响。上述标识粘贴在机器背面。

下表是依据 SJ/T 11364-2014 的规定编制。

产品中有害物质的名称及含量

部件名称	有害物质					
	铅 (Pb)	汞 (Hg)	镉 (Cd)	六价铬 (Cr (VI))	多溴联苯 (PBB)	多溴二苯醚 (PBDE)
印刷电路板	×	○	○	○	○	○
机箱	○	○	○	○	○	○
液晶显示器	×	○	○	○	○	○
其他	×	○	○	○	○	○

本表格依据 SJ/T 11364 的规定编制。

○ : 表示该有害物质在该部件所有均质材料中的含量均在 GB/T 26572 规定的限量要求以下。

× : 表示该有害物质至少在该部件的某一均质材料中的含量超出 GB/T 26572 规定的限量要求。

