

User's Manual

FlexScan® S2411W-U

Color LCD Monitor

Important

Please read this User's Manual and Setup Manual (separate volume) carefully to familiarize yourself with safe and effective usage.

PRECAUTIONS

Chapter 1 Features and Overview

- 1-1 Features
- 1-2 Switches and Indicators
- 1-3 Functions and Basic Operation

Chapter 2 Settings and Adjustments

- 2-1 Utility Disk
- 2-2 Screen Adjustment
- 2-3 Color Adjustment
- 2-4 Off Timer/Power Saving Settings
- 2-5 Screen Size Selection
- 2-6 Power Indicator/EIZO Logo Display Setting
- 2-7 Beeper Settings
- 2-8 Locking Switches
- 2-9 Setting Adjustment Menu Display
- 2-10 Viewing Information/Setting Language
- 2-11 Resumption of Default Setting

Chapter 3 Connecting Cables

- 3-1 Connecting Two PCs to the Monitor
- 3-2 Connecting Peripheral USB Devices

Chapter 4 Troubleshooting

Chapter 5 Reference

- 5-1 Attaching an Arm
- 5-2 Cleaning
- 5-3 Specifications
- 5-4 Glossary
- 5-5 Preset Timing





How to Setup

Please read the Setup Manual (separate volume)



SAFETY SYMBOLS

This manual uses the safety symbols below. They denote critical information. Please read them carefully.

 <p>WARNING Failure to abide by the information in a WARNING may result in serious injury and can be life threatening.</p>	 <p>CAUTION Failure to abide by the information in a CAUTION may result in moderate injury and/or property or product damage.</p>
	<p>Indicates a prohibited action.</p>
	<p>Indicates a mandatory action that must be followed.</p>

Copyright© 2006-2007 EIZO NANA O CORPORATION All rights reserved.

No part of this manual may be reproduced, stored in a retrieval system, or transmitted, in any form or by any means, electronic, mechanical, or otherwise, without the prior written permission of EIZO NANA O CORPORATION. EIZO NANA O CORPORATION is under no obligation to hold any submitted material or information confidential unless prior arrangements are made pursuant to EIZO NANA O CORPORATION's receipt of said information. Although every effort has been made to ensure that this manual provides up-to-date information, please note that EIZO monitor specifications are subject to change without notice.

ENERGY STAR is a U.S. registered mark.
 Apple and Macintosh are registered trademarks of Apple Inc.
 VGA is a registered trademark of International Business Machines Corporation.
 DPMS is a trademark and VESA is a registered trademark of Video Electronics Standards Association.
 Windows is a registered trademark of Microsoft Corporation.
 PowerManager and UniColor Pro are trademarks of EIZO NANA O CORPORATION.
 FlexScan, ScreenManager and EIZO are registered trademarks of EIZO NANA O CORPORATION in Japan and other countries.

<p>As an ENERGY STAR® Partner, EIZO NANA O CORPORATION has determined that this product meets the ENERGY STAR guidelines for energy efficiency.</p>	
---	---

<p>Product specification may vary with sales areas. Confirm the specification in the manual written in language of the region of purchase.</p>

⚠ PRECAUTIONS

IMPORTANT

- This product has been adjusted specifically for use in the region to which it was originally shipped. If the product is used outside the region, it may not operate as specified in the specifications.
- To ensure personal safety and proper maintenance, please read carefully this section and the caution statements on the monitor.

[Location of Caution Statement]

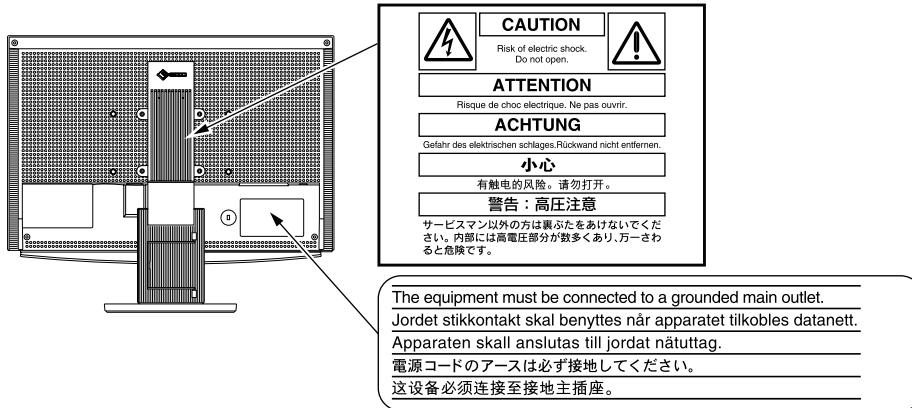

⚠ WARNING

If the unit begins to emit smoke, smells like something is burning, or makes strange noises, disconnect all power connections immediately and contact your dealer for advice.

Attempting to use a malfunctioning unit may result in fire, electric shock, or equipment damage.

Do not open the cabinet or modify the unit.

Opening the cabinet or modifying the unit may result in fire, electric shock, or burn.



Refer all servicing to qualified service personnel.

Do not attempt to service this product yourself as opening or removing covers may result in fire, electric shock, or equipment damage.

Keep small objects or liquids away from the unit.

Small objects accidentally falling through the ventilation slots into the cabinet or spillage into the cabinet may result in fire, electric shock, or equipment damage.

If an object or liquid falls/spills into the cabinet, unplug the unit immediately. Have the unit checked by a qualified service engineer before using it again.



WARNING

Place the unit at the strong and stable place.

A unit placed on an inadequate surface may fall and result in injury or equipment damage. If the unit falls, disconnect the power immediately and ask your dealer for advice. Do not continue using a damaged unit. Using a damaged unit may result in fire or electric shock.

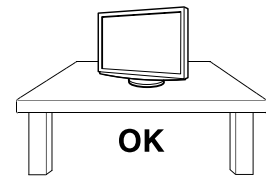

Set the unit in an appropriate location.

Not doing so may result in fire, electric shock, or equipment damage.

- Do not place outdoors.
- Do not place in the transportation system (ship, aircraft, trains, automobiles, etc.)
- Do not place in a dusty or humid environment.
- Do not place in a location where the steam comes directly on the screen.
- Do not place near heat generating devices or a humidifier.

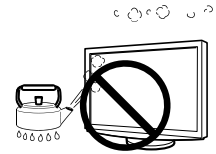

To avoid danger of suffocation, keep the plastic packing bags away from babies and children.

Use the enclosed power cord and connect to the standard power outlet of your country.

Be sure to remain within the rated voltage of the power cord.

Not doing so may result in fire or electric shock.

To disconnect the power cord, grasp the plug firmly and pull.

Tugging on the cord may damage and result in fire or electric shock.



The equipment must be connected to a grounded main outlet.

Failure to do so may result in fire or electric shock.



Use the correct voltage.

- The unit is designed for use with a specific voltage only. Connection to another voltage than specified in this User's Manual may cause fire, electric shock, or equipment damage.
 - Do not overload your power circuit, as this may result in fire or electric shock.
-

WARNING

Handle the power cord with care.

- Do not place the cord underneath the unit or other heavy objects.
- Do not pull on or tie the cord.

If the power cord becomes damaged, stop using it. Use of a damaged cord may result in fire or electric shock.



Never touch the plug and power cord if it begins to thunder.

Touching them may result in electric shock.

When attaching an arm stand, please refer to the user's manual of the arm stand and install the unit securely.

Not doing so may cause the unit to become unattached, which may result in injury or equipment damage. When the unit is dropped, please ask your dealer for advice. Do not continue using a damaged unit. Using a damaged unit may result in fire or electric shock. When reattaching the tilt stand, please use the same screws and tighten them securely.

Do not touch a damaged LCD panel directly with bare hands.

The liquid crystal that may leak from the panel is poisonous if it enters the eyes or mouth. If any part of the skin or body comes in direct contact with the panel, please wash thoroughly. If some physical symptoms result, please consult your doctor.



Follow local regulation or laws for safe disposal.

The backlight of the LCD panel contains mercury.

CAUTION

Handle with care when carrying the unit.

Disconnect the power cord and cables when moving the unit. Moving the unit with the cord attached is dangerous. It may result in injury.

When handling the unit, grip the bottom of the unit firmly with both hands ensuring the panel faces outward before lifting.

Dropping the unit may result in injury or equipment damage.

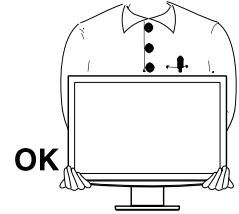

Do not block the ventilation slots on the cabinet.

- Do not place any objects on the ventilation slots.
- Do not install the unit in a closed space.
- Do not use the unit laid down or upside down.

Blocking the ventilation slots prevents proper airflow and may result in fire, electric shock, or equipment damage.

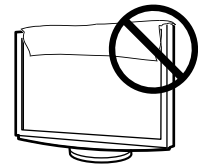

Do not touch the plug with wet hands.

Doing so may result in electrical shock.



Use an easily accessible power outlet.

This will ensure that you can disconnect the power quickly in case of a problem.

Periodically clean the area around the plug.

Dust, water, or oil on the plug may result in fire.

Unplug the unit before cleaning it.

Cleaning the unit while it is plugged into a power outlet may result in electric shock.

If you plan to leave the unit unused for an extended period, disconnect the power cord from the wall socket after turning off the power switch for the safety and the power conservation.

LCD Panel

In order to suppress the luminosity change by long-term use and to maintain the stable luminosity, use of a monitor in lower brightness is recommended.

The LCD panel is manufactured using high-precision technology. However, note that the appearance of any missing pixels or lit pixels does not indicate damage to the LCD monitor.

Percentage of effective pixels: 99.9994% or higher.

The backlight of the LCD panel has a fixed life span. When the screen becomes dark or begins to flicker, please contact your dealer.

Do not press on the panel or edge of the frame strongly, as this may result in damage to the screen. There will be prints left on the screen if the pressed image is dark or black. If pressure is repeatedly applied to the screen, it may deteriorate or damage your LCD panel. Leave the screen white or black to decrease the prints.

Do not scratch or press on the panel with any sharp objects, such as a pencil or pen as this may result in damage to the panel. Do not attempt to brush with tissues as this may scratch the LCD panel.

When the monitor is cold and brought into a room or the room temperature goes up quickly, dew condensation may occur inside and outside the monitor. In that case, do not turn the monitor on and wait until dew condensation disappears, otherwise it may cause damage to the monitor.

When the screen image is changed after displaying the same image for extended periods of time, an afterimage may appear. Use the screen saver or timer to avoid displaying the same image for extended periods of time.

To use the monitor comfortably

An excessively dark or bright screen may affect your eyes. Adjust the brightness of the monitor according to the environmental conditions.

Staring at the monitor for a long time tires your eyes. Take a 10-minute rest every hour.

CONTENTS

PRECAUTIONS	1	2-7 Beeper Settings	20
LCD Panel.....	5	• To set the beeper [Beep]	20
To use the monitor comfortably	5	2-8 Locking Switches	21
Chapter 1 Features and Overview	7	• To lock operation [Adjustment Lock].....	21
1-1 Features	7	2-9 Setting Adjustment Menu Display	21
1-2 Switches and Indicators	7	• To update menu settings	
1-3 Functions and Basic Operation	8	[Menu Size/Menu Position/Menu Off Timer/ Translucent].....	21
Chapter 2 Settings and Adjustments	10	2-10 Viewing Information/Setting Language	22
2-1 Utility Disk	10	• To check settings, usage time, etc.	
• Disk Contents	10	[Information]	22
• To use UniColor Pro	10	• To set a language to be displayed	
• To use ScreenManager Pro for LCD	10	[Language]	22
2-2 Screen Adjustment	11	2-11 Resumption of Default Setting	23
Digital Input.....	11	• To reset color adjustment [Reset].....	23
Analog Input	11	• To reset all settings [Reset]	23
2-3 Color Adjustment	14	Chapter 3 Connecting Cables	24
Simple adjustment [FineContrast mode]	14	3-1 Connecting Two PCs to the Monitor	24
• FineContrast Mode.....	14	• To set priority of PC to be displayed	
• To select FineContrast mode.....	14	[Input Priority]	25
• To update color setting of FineContrast mode..	14	3-2 Connecting Peripheral USB Devices	25
Advanced Adjustments [Adjustment menu].....	15	Chapter 4 Troubleshooting	26
• To select an appropriate mode for images	15	Chapter 5 Reference	28
• To set/adjust color	16	5-1 Attaching an Arm	28
2-4 Off Timer/Power Saving Settings	17	5-2 Cleaning	29
• To set monitor power-off time [Off Timer]	17	5-3 Specifications	30
• To set monitor power-saving		5-4 Glossary	33
[VESA DPMS/DVI DMPM].....	18	5-5 Preset Timing	35
2-5 Screen Size Selection	19		
• To change screen size [Screen Size]	19		
• To adjust brightness of non-display area			
[Border Intensity]	19		
2-6 Power Indicator/EIZO Logo Display Setting	20		
• To turn off the Power indicator while a screen is			
displayed [Power Indicator]	20		
• To display EIZO logo [EIZO Logo Appearing			
Function].....	20		

Chapter 1 Features and Overview

Thank you very much for choosing an EIZO color LCD monitor.

1-1 Features

- 24" wide format LCD
- Applicable to HDCP
- Equipped with the ContrastEnhancer and OutlineEnhancer functions
- Dual-input compliant (DVI-I x 2 connectors)
- DVI digital input (TMDS) compliant
- Horizontal scan frequency, Vertical scan frequency and Resolution are as follows;

Horizontal scan frequency	Analog	24 - 94 kHz
	Digital	31 - 76 kHz
Vertical scan frequency	Analog	49 - 86 Hz
		49 - 76 Hz (1600 x 1200)
		49 - 61 Hz (1920 x 1200)
	Digital	59 - 61 Hz
		69 - 71 Hz (VGA TEXT)
	49 - 51 Hz (1080p@50Hz)	
Resolution	1920 dots x 1200 lines	

- Compatible with frame synchronization mode
 - 59 - 61 Hz
 - 49 - 51 Hz : 1080p@50Hz (Digital)
- Smoothing (soft - sharp) function for adjustment of enlarged images
- FineContrast mode to allow the best mode for screen display
- The application software "UniColor Pro" to simulate the views experienced by people with some sort of color deficiency is included (refer to the EIZO LCD Utility Disk)
- The utility software "ScreenManager Pro for LCD" (for Windows) to control the monitor from a PC with mouse/keyboard is included (refer to the EIZO LCD Utility Disk).
- The ArcSwing 2 Stand enables to adjust the monitor height and monitor angle freely

1-2 Switches and Indicators

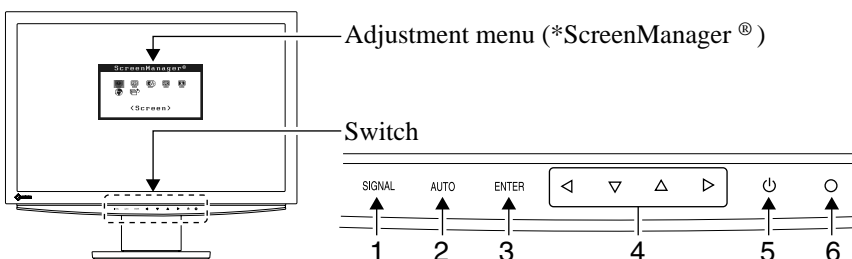

1. Input signal selection switch
2. Auto adjustment switch
3. Enter switch
4. Control switches (Left, Down, Up, Right)
5. Power switch
6. Power indicator

Indicator status	Operation status
Blue	The screen is displayed
Orange	Power saving
Off	Power off

* ScreenManager® is an EIZO's nickname of the Adjustment menu.

NOTE

- The stand of the unit can be replaced with an arm or another stand. (Refer to "5-1 Attaching an Arm" on page 28.)

NOTE

- While the screen is displayed, the blue power indicator that is lighting blue can be turned off (see "Power Indicator/Logo Display Setting," on page 20).
- For the power indicator status with "Off Timer" set, refer to "To set monitor power-off time" on page 17.

1-3 Functions and Basic Operation

To adjust the screen and color

ENTER Main menu (Refer to page 9 for operation)

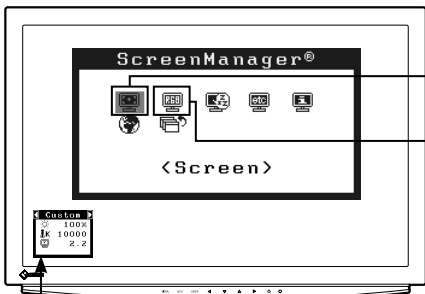

- The Adjustment menu and the FineContrast menu cannot be displayed at the same time.

◀ ▶ FineContrast menu

Color adjustment Page 14

Simple adjustment [FineContrast mode]

This function allows easy selection of a desired mode from six modes according to monitor application.

Custom ☀ 100% 🌡 Off 📺 2.2	sRGB ☀ 100% 🌡 6500 📺 2.2
Movie ☀ 100% 🌡 6500 📺 2.2	External ☀ 100% 🌡 Off 📺 Fixed
Picture ☀ 100% 🌡 6500 📺 Fixed	Text ☀ 40% 🌡 5000 📺 2.2

• “Brightness,” “Temperature,” and “Gamma” can be set for each mode (Custom/Movie/Picture/Text/External/sRGB).
Settable functions vary with the display mode.

△ ▽

Brightness Adjustment

Touch △ or ▽ to adjust brightness.

AUTO Analog input only

1 Automatic Adjustment Page 11

Touch AUTO.
Touch AUTO again.



2 Screen Adjustment Page 11

Screen

<Clock>

- To eliminate vertical bars [Clock*] ... see page 12
- To remove flickering or blurring [Phase*]..... see page 12
- To correct screen position [Position*] see page 12
- To adjust extra or cut image [Resolution*] see page 13
- To adjust color gradation automatically [Range Adjustment*] see page 13
- To modify blurred characters/lines [Smoothing] see page 13
- To set when a noise appears on the screen [Signal Filter*] see page 27

* Items marked with * can be adjusted with analog input.

Color Adjustment Page 15

Advanced Adjustment

Color (Custom)

<Brightness>

- “Brightness,” “Temperature,” “Gamma,” “Saturation,” “Hue,” “Gain,” “6 Colors” and “Enhancer” can be set for each mode (Custom/Movie/Picture/Text/External/sRGB).
Settable functions vary with the display mode.

Resuming the default settings

- To reset color adjustment [Reset] ... see page 23

To make useful settings/adjustments

ENTER Adjustment menu (Refer to below for operation)

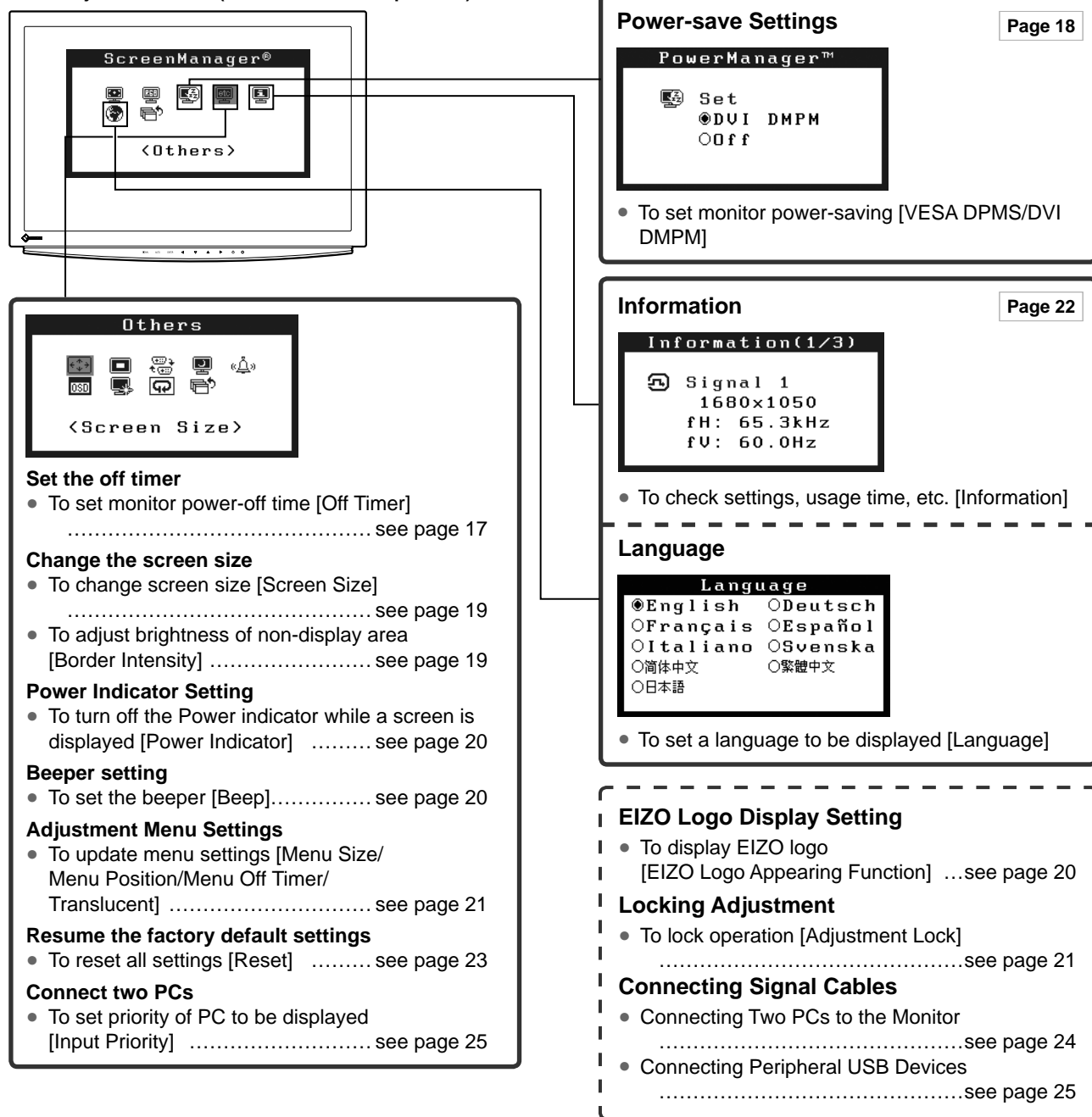

Basic operation of Adjustment menu

[Displaying Adjustment menu and selecting function]

- (1) Touch ENTER. The Main menu appears.
- (2) Select a function with $\Delta / \nabla / \triangleleft / \triangleright$, and touch ENTER. The Sub menu appears.
- (3) Select a function with $\Delta / \nabla / \triangleleft / \triangleright$, and touch ENTER. The adjustment/setting menu appears.
- (4) Adjust the selected item with $\Delta / \nabla / \triangleleft / \triangleright$, and touch ENTER. The setting is saved.

[Exiting Adjustment menu]

- (1) Choose <Return> from the Sub menu and touch ENTER. The Main menu appears.
- (2) Choose <Exit> from the Main menu and touch ENTER. The Adjustment menu quits.

NOTE

- The Adjustment menu can also be exited by touching ENTER twice quickly.
- <Exit> or <Return> can also be selected by touching the ∇ switch twice in the Main menu or Sub menu.

Chapter 2 Settings and Adjustments

2-1 Utility Disk

An “EIZO LCD Utility Disk” (CD-ROM) is supplied with the monitor. The following table shows the disk contents and the overview of the application software programs.

- **Disk Contents**

- Disk contents and software overview

The disk includes a monitor information file, application software programs for adjustment, and User’s Manual. Refer to “Readme.txt” or the “Readme” file on the disk for software startup procedures or file access procedures.

Item	Overview	For Windows	For Macintosh
A “Readme.txt” or “Readme” file		○	○
Color Profiles (ICC Profiles)	Color profiles	○	○
Screen Adjustment Program	Available for easy adjustments of the monitor screen following adjustment patterns and procedures on the screen.	○	○
UniColor Pro	An application software to simulate the views experienced by some colorblind people. (A PC must be connected to the monitor with the supplied USB cable.) Refer to the description later.	○	○
ScreenManager Pro for LCD (for Windows)	A utility software program to control monitor adjustments from a PC using its mouse and keyboard. (A PC must be connected to the monitor with the supplied USB cable.) Refer to the description later.	○	—
WindowMovie Checker Software	WindowMovie is a function of ScreenManager Pro for LCD. For more information, refer to the User’s Manual of ScreenManager Pro for LCD on the disk.		
User’s Manual of this monitor (PDF file)			
UniColor Pro User’s Manual (PDF file)			
Color Universal Design Handbook (PDF file)			

- **To use UniColor Pro**

For the installation and use of UniColor Pro, refer to the UniColor Pro User’s Manual on the disk.

- **To use ScreenManager Pro for LCD**

For the installation and use of ScreenManager Pro for LCD, refer to its User’s Manual on the disk.

2-2 Screen Adjustment

Digital Input

When digital signals are input, images are displayed correctly based on the preset data of the monitor.

Analog Input

The monitor screen adjustment is used to suppress flickering of the screen or adjust screen position and screen size correctly according to the PC to be used. To use the monitor comfortably, adjust the screen when the monitor is set up for the first time or when the settings of the PC in use are updated.

[Adjustment Procedure]

1 Touch AUTO.

A message “Your setting will be lost, if you touch again now” appears for five seconds.

2 Touch AUTO again while the message is displayed.

The Auto Adjustment function begins (showing a running status icon) to adjust clock, phase, display position, and resolution automatically.

If satisfactory adjustment cannot be obtained with the AUTO button, perform the adjustment following the procedure below. When the screen is displayed correctly, go to step 5 “Range Adjustment”.

• Advanced Adjustment

3 Run the Screen Adjustment Program.

Load the EIZO LCD Utility Disk on the PC, and start the Screen Adjustment Program compatible with the PC in use.

After the program starts up, perform the adjustment in step 4 following the instructions of the program.

Attention

- Wait 30 minutes or more from monitor power on before starting adjustments.

NOTE

- Auto adjustment is available using the AUTO. If satisfactory adjustment cannot be obtained with this button, perform advanced adjustments using the Adjustment menu. Use “Screen Adjustment Program” on the supplied EIZO LCD Utility Disk.

Attention

- This function works correctly when an image is fully displayed over the Windows or Macintosh display area. It does not work properly when an image is displayed only on a part of the screen (DOS prompt window, for example) or when a black background (wallpaper, etc.) is in use.
- This function does not work correctly with some graphics boards.

NOTE

- For how to start the Screen Adjustment Program, refer to “Readme.txt” or the “Readme” file. When you are using a Windows PC, you can run the program directly from the start menu of the disk.
- If no adjustment program is available for your PC, display a checkerboard pattern on the screen (see below) and go to the following steps.

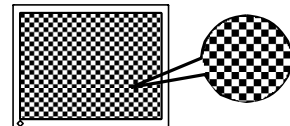

4 Perform advanced adjustments for the following using the <Screen> menu of the Adjustment menu.

- **To eliminate vertical bars [Clock]**

- (1) Choose <Clock> from the <Screen> menu, and touch ENTER.
The <Clock> menu appears.
- (2) Adjust the clock with ◀ or ▶, and touch ENTER.
The adjustment is completed.

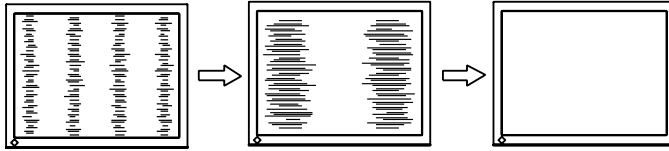

- **To remove flickering or blurring [Phase]**

- (1) Choose <Phase> from the <Screen> menu, and touch ENTER.
The <Phase> menu appears.
- (2) Adjust the phase with ◀ or ▶, and touch ENTER.
The adjustment is completed.

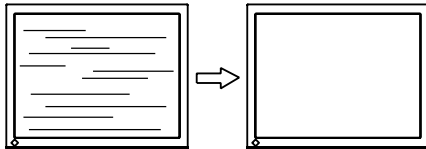

- **To correct screen position [Position]**

Since the number of pixels and the pixel positions are fixed on the LCD monitor, only one position is provided to display images correctly. The position adjustment is made to shift an image to the correct position.

- (1) Choose <Position> from the <Screen> menu, and touch ENTER.
The <Position> menu appears.
- (2) Adjust the position with ▲ / ▼ / ◀ / ▶ to display the image properly in the display area of the monitor.

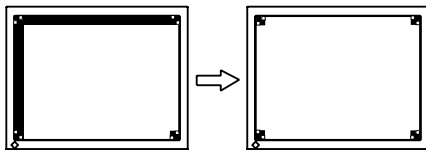

NOTE

- Touch the control button slowly so as not to miss the adjustment point.
- When blurring, flickering or bars appear on the screen after adjustment, proceed to [Phase] to remove flickering or blurring.

Attention

- Flickering or blurring may not be eliminated depending on your PC or graphics board.

NOTE

- When vertical bars appear on the screen after adjustment, go back to “To eliminate vertical bars [Clock].” (Clock → Phase → Position)

- **To adjust extra or cut image [Resolution]**

This adjustment is available to equalize the resolution shown on the Setting menu and the resolution of input signal.

(1) Choose <Resolution> from the <Screen> menu, and touch ENTER.
The <Resolution> menu appears.

(2) Adjust the vertical resolution with Δ or ∇ , and then horizontal resolution with \triangleleft or \triangleright , and touch ENTER.

The adjustment is completed.

Extra image is displayed due to excessive dots.

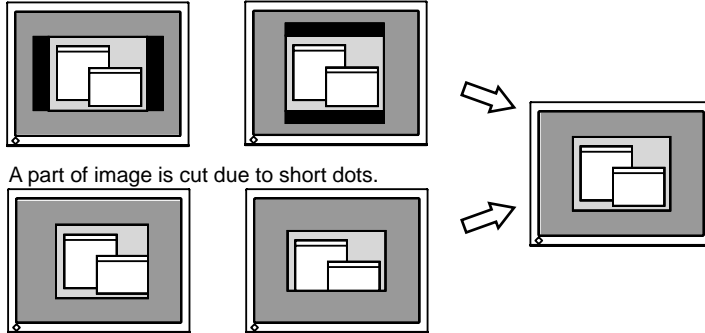

5 Adjust the signal output range

- **To adjust color gradation automatically [Range Adjustment]**

Every color gradation (0 to 255) can be displayed by adjusting the signal output level.

(1) Choose <Range Adjustment> from the <Screen> menu, and touch ENTER.

A message “Your setting will be lost if you touch AUTO switch” appears.

(2) Touch AUTO while the message is displayed.

The output range is adjusted automatically.

When using the “Screen Adjustment Program”, the program is finished.

6 Change the smoothing setting.

- **To modify blurred characters/lines [Smoothing]**

When a low-resolution image is displayed in the “Full” or “Enlarged” mode, the characters or lines of the displayed image may be blurred.

(1) Choose <Screen> from the Adjustment menu, and touch ENTER.

(2) Choose <Smoothing> from the <Screen> menu, and touch ENTER.
The <Smoothing> menu appears.

(3) Select a suitable level from 1 to 5 (where 1 = soft and 5 = sharp) with \triangleleft or \triangleright , and touch ENTER.

The smoothing adjustment is completed.

Attention

- Smoothing setting may not be required depending on the display resolution. (You cannot choose the smoothing icon.)

2-3 Color Adjustment

Simple adjustment [FineContrast mode]

This function allows you to select the best display mode for monitor brightness, etc.

• FineContrast Mode

An appropriate display mode is selectable out of six modes.

Mode	Purpose
Custom	Available for making desired setting.
sRGB	Suitable for color matching with sRGB compatible peripherals.
External	Switches to this External mode when you start up the UniColor Pro and perform the simulation.
Text	Suitable for displaying texts for word processing or spreadsheets.
Picture	Suitable for displaying images such as photos or picture images.
Movie	Suitable for playing back animated images.

FineContrast menu
Example) Custom

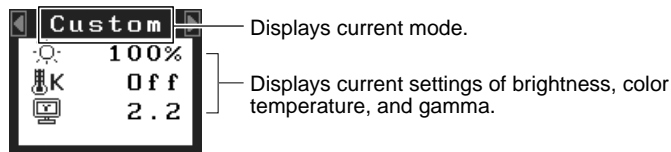

• To select FineContrast mode

- (1) Touch ◀ or ▶.

The FineContrast menu appears at the lower left of the screen.

- (2) Choose a desired mode with ◀ and ▶, and touch ENTER.

The adjustment is completed.

• To update color setting of FineContrast mode

<Brightness>, <Temperature>, and <Gamma> can be set or adjusted.

- (1) Choose a desired function from the FineContrast menu with ▲ or ▼.

- (2) Adjust the selected function with ◀ or ▶, and touch ENTER.

The adjustment is completed.

NOTE

- The Adjustment menu and the FineContrast menu cannot be displayed at the same time.

Attention

- Color temperature values and gamma values are fixed in some modes. Set them as shown in “To select an appropriate mode for images” on page 15.

NOTE

- The <Color> menu of the Adjustment menu allows advanced color adjustments for each mode. Refer to “To select an appropriate mode for images” on page 15.

Advanced Adjustments [Adjustment menu]

Independent setting and saving of color adjustment are available for each FineContrast mode.

• To select an appropriate mode for images

✓: Adjustment available -: Invalid for adjustment

Icon	Function		FineContrast mode					
			Custom	sRGB	External	Text	Picture	Movie
	Brightness	*	✓	✓	✓	✓	✓	✓
	Temperature	*	✓	-	-	✓	✓	✓
	Gamma	*	✓	-	-	✓	-	-
	Saturation		✓	-	-	✓	✓	✓
	Hue		✓	-	-	✓	✓	✓
	Gain		✓	-	-	-	-	-
	6 Colors		✓	-	-	-	-	-
	Contrast Enhancer		✓	-	-	-	✓	✓
	Outline Enhancer		✓	-	-	-	✓	✓
	Reset		✓	✓	✓	✓	✓	✓

* These items can also be set or adjusted with the FineContrast menu.







Menu	Description	Adjustment range
Brightness 	To adjust the full screen brightness as desired	0 to 100%
	NOTE <ul style="list-style-type: none"> You can also adjust the brightness by touching Δ or ∇ button while the adjustment menu is not displayed. Touch ENTER after adjustment. The values shown in the “%” are available only as reference. 	
Temperature 	To select a color temperature	4000K to 10000K in units of 500K (including 9300K).
	NOTE <ul style="list-style-type: none"> Setting the value to “Off” presents the natural color temperature of the panel. The values shown in the Kelvin (K) are available only as reference. 	
Gamma 	To set a gamma value	1.4 to 3.0, Fixed
	NOTE <ul style="list-style-type: none"> Digital signal input is recommended for gamma value setting. Set a gamma value to 1.8 - 2.2 for analog signal input. Only when selecting <Custom> in the fine contrast mode, “Fixed” is available. 	
Saturation 	To adjust color saturation	-100 to 100 Setting the minimum (-100) turns the image to a monochrome screen.
	Attention <ul style="list-style-type: none"> This function does not enable to display every color gradation. 	

Attention

- Perform [Range Adjustment] before starting color adjustment for analog input signals.
Refer to “To adjust color gradation automatically” on page 13.
- The FineContrast mode cannot be changed during color adjustment. Set the FineContrast mode in advance with \triangleleft / \triangleright .
- Wait 30 minutes or more from monitor power on before starting the color adjustment.
- Choose “Reset” in the <Color> menu to revert to the default settings (factory settings) of hue of the color mode selected.
- The same image may be seen in different colors on multiple monitors due to their monitor-specific characteristics. Make fine color adjustment visually when matching colors on multiple monitors.

NOTE

- The Adjustment menu and the FineContrast menu cannot be displayed at the same time.
- Adjustable functions vary depending on the type of FineContrast mode.

Menu	Description	Adjustment range
Hue 	To produce a desired skin color, etc.	-100 to 100
	Attention <ul style="list-style-type: none"> This function does not enable to display every color gradation. 	
Gain 	To adjust red, green, and blue to a desired color tone respectively	0 to 100% Adjust the respective brightness of red/green/blue to make a desired color tone. Display an image with white or gray background for adjustment.
	NOTE <ul style="list-style-type: none"> The values shown in the “%” are available only as reference. When using the <Gain> setting, the <Temperature> setting is set to “Off.” 	
6 Colors 	To adjust <Hue> and <Saturation> in Red, Yellow, Green, Cyan, Blue, and Magenta respectively	Hue: -100 to 100 Saturation: -100 to 100
Enhancer 	ContrastEnhancer  (Refer to page 33) This can change the feeling of contrast the image.	On/Off
	OutlineEnhancer  (Refer to page 33) This emphasize the outline of the image and shade it off.	-3 to 3
	NOTE <ul style="list-style-type: none"> “ContrastEnhancer” and “OutlineEnhancer” are suitable function for the playback of moving image or photograph indication. 	
Reset 	To reset the color settings of the selected FineContrast mode to the default settings	

• To set/adjust color

- (1) Choose <Color> from the Adjustment menu, and touch ENTER.
- (2) Select a desired function from the <Color> menu, and touch ENTER.
The selected function menu appears.
- (3) Adjust the selected item with Δ / ∇ / \triangleleft / \triangleright , and touch ENTER.
The adjustment is completed.

2-4 Off Timer/Power Saving Settings

• To set monitor power-off time [Off Timer]





This function allows the monitor to automatically turn off after a specified time has passed. This function serves to reduce afterimages caused when the monitor screen is left on for a long time period without use. Use this function when an image is displayed throughout the day.

[Off Timer System]

Timer	Monitor	Power Indicator
ON time (1H - 23H)	Operating	Blue
Last 15 min. in "ON time"	Advance Notice* ¹	Flashing blue
"ON time" expired	Power Off	Off

*¹ When  is touched during the advance notice period, the monitor continues to operate for additional 90 minutes. Extension of operation time can be set without limitation.

[Procedure]

- (1) Choose <Others> from the Adjustment menu, and touch ENTER.
- (2) Choose <Off Timer> from the <Others> menu, and touch ENTER.
The <Off Timer> menu appears.
- (3) Select "Enable" with  or .
- (4) Set a monitor ON time (1 to 23 hours) with  or , and touch ENTER.
The Off Timer setting is completed.

[Resumption Procedure]

- (1) Touch .

Attention

- The Off Timer functions even in the power saving mode, but the advance notice is disabled. The monitor power is turned off without advance notice.

- **To set monitor power-saving [VESA DPMS/DVI DMPM]**

- **Analog input**

This monitor complies with the VESA DPMS standard.

[Power Saving System]

PC		Monitor	Power Indicator
Operating		Operating	Blue
Power saving	STAND-BY SUSPENDED OFF	Power saving	Orange

[Procedure]

- (1) Choose <PowerManager> from the Adjustment menu, and touch ENTER.
The <Set> menu appears.
- (2) Select “VESA DPMS” with Δ or ∇ , and touch ENTER.
The power saving setting is completed.

[Resumption Procedure]

- Operate the mouse or keyboard to resume the normal screen.

- **Digital input**

This monitor complies with the DVI DMPM standard.

[Power Saving System]

The monitor enters the power saving mode in five seconds in connection with the PC setting.

PC	Monitor	Power Indicator
Operating	Operating	Blue
Power saving	Power saving	Orange

[Procedure]

- (1) Choose <PowerManager> from the Adjustment menu, and touch ENTER.
The <Set> menu appears.
- (2) Select “DVI DMPM” with Δ or ∇ , and touch ENTER.
The power saving setting is completed.

[Resumption Procedure]

- Operate the mouse or keyboard to resume the normal screen.

Attention

- Unplugging the power cord completely shuts off power supply to the monitor.
- USB compliant devices connected to the monitor work even if the monitor is in the power saving mode. Therefore, power consumption of the monitor varies with connected devices even in the power saving mode.

2-5 Screen Size Selection

• To change screen size [Screen Size]

The image with the resolution other than the recommended resolution is displayed in full screen automatically. You can change the screen size by using <Screen size> from <Others> menu.

Menu	Function
Full (default setting)	Displays an image in full screen. Images are distorted in some cases because the vertical rate is not equal to the horizontal rate.
Enlarged	Displays an image in full screen. In some cases, a blank horizontal or vertical border appears to equalize the vertical rate and the horizontal rate.
Normal	Displays images with the specified resolution.

Example: Image size 1280 x 1024

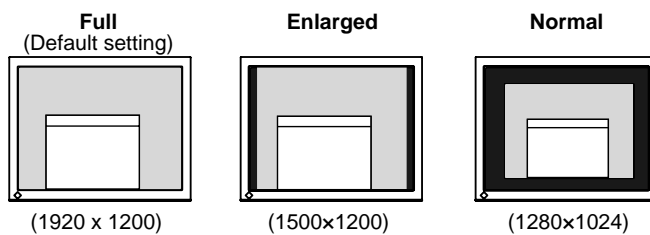

[Procedure]

- (1) Choose <Others> from the Adjustment menu, and touch ENTER.
- (2) Choose <Screen Size> from the <Others> menu, and touch ENTER.
The screen size setting window appears.
- (3) Select “Full,” “Enlarged,” or “Normal” with Δ or ∇ , and touch ENTER.
The screen size setting is completed.

• To adjust brightness of non-display area [Border Intensity]

A border (black area with no image) around the image appears in the “Normal” or “Enlarged” mode.

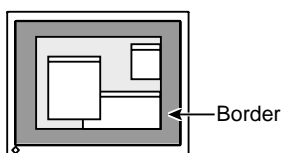

- (1) Choose <Others> from the Adjustment menu, and touch ENTER.
- (2) Choose <Border Intensity> from the <Others> menu, and touch ENTER.
The <Border Intensity> menu appears.
- (3) Adjust border intensity with \triangleleft or \triangleright , and touch ENTER.
The border intensity adjustment is completed.

2-6 Power Indicator/EIZO Logo Display Setting

• To turn off the Power indicator while a screen is displayed [Power Indicator]

This function enables to turn off the Power indicator (blue) while a screen is displayed.

- (1) Choose <Others> from the Adjustment menu, and touch ENTER.
- (2) Choose <Power Indicator> from the <Others> menu, and touch ENTER.
The <Power Indicator> menu appears.
- (3) Select “Disable” with Δ or ∇ , and touch ENTER.
The Power Indicator setting is completed.

• To display EIZO logo [EIZO Logo Appearing Function]

When this unit is turned on, the EIZO logo appears at the center of the screen. Selection to display or not to display the logo is available with this function.

[Procedure]

- (1) Touch ⏻ to power off the unit.
- (2) Touch ⏻ again while touching ENTER.
The EIZO logo does not appear on the screen.

[Resetting]

- (1) Touch ⏻ to power off the unit.
- (2) Touch ⏻ again while touching ENTER.
The logo appears again.

2-7 Beeper Settings

• To set the beeper [Beep]

Set the beeper on/off for operation tone of the switches, connection error, etc.

Sound type	Conditions for beeping
Short beep	<ul style="list-style-type: none"> • When an item is selected with ENTER • When a maximum or minimum value is set with the control switches • When SIGNAL is touched.
Long beep	<ul style="list-style-type: none"> • When AUTO is touched. • When registration is performed with ENTER
Consecutive beeps	<ul style="list-style-type: none"> • When the monitor is not connected correctly • When the PC is not turned on • When a frequency out of the specified range is received
Beep-beep once every 15 seconds	<ul style="list-style-type: none"> • 15 minutes before the power off time set by “Off Timer” (advance notice time)

- (1) Choose <Others> from the Adjustment menu, and touch ENTER.
- (2) Choose <Beep> from the <Others> menu, and touch ENTER.
The <beep> menu appears.
- (3) Select On or Off with Δ or ∇ , and touch ENTER.
The beep setting is completed.

NOTE

- The Power indicator lights up at power on with the default setting.

NOTE



- The logo appears with the default setting.

2-8 Locking Switches



• To lock operation [Adjustment Lock]

This function locks the switches to retain the status adjusted or set once.

Switches that can be locked	<ul style="list-style-type: none">• ENTER (Enter switch) Adjustments/settings using Adjustment menu• AUTO (Auto Adjustment switch)
Switches that cannot be locked	<ul style="list-style-type: none">• FineContrast mode selection/adjustment using ◀/▶ switches• Brightness adjustment using ▲ / ▼ switches• SIGNAL (Input Signal Selection switch)

- (1) Touch  to turn off the unit.
- (2) Touch  again while touching AUTO.
The screen is displayed with the adjustment lock.

[Unlocking]

- (1) Touch  to turn off the unit.
- (2) Touch  again while touching AUTO.
The screen is displayed with the adjustment lock released.

2-9 Setting Adjustment Menu Display

• To update menu settings [Menu Size/Menu Position/Menu Off Timer/Translucent]

Menu Size

Change the Adjustment menu size using the following procedure.

- (1) Choose <Others> from the Adjustment menu, and touch ENTER.
- (2) Choose <Menu Settings> from the <Others> menu, and touch ENTER.
- (3) Choose <Menu Size> from the <Menu Settings> menu, and touch ENTER.
The <Menu Size> menu appears.
- (4) Select “Enlarged” using ▲ or ▼, and touch ENTER.
The menu size setting is completed.

Menu Position

Adjust the menu position using the following procedure.

- (1) Choose <Others> from the Adjustment menu, and touch ENTER.
- (2) Choose <Menu Settings> from the <Others> menu, and touch ENTER.
- (3) Choose <Menu Position> from the <Menu Settings> menu, and touch ENTER.
The <Menu Position> menu appears.
- (4) Select a menu position with ▲ / ▼ / ◀ / ▶, and touch ENTER.
The menu position setting is completed.

Menu Off Timer

Set the menu display time using the following procedure.

- (1) Choose <Others> from the Adjustment menu, and touch ENTER.
- (2) Choose <Menu Settings> from the <Others> menu, and touch ENTER.
- (3) Choose <Menu Off Timer> from the <Menu Settings> menu, and touch ENTER.
The <Menu Off Timer> menu appears.
- (4) Select “Enable” with ▲ or ▼.
- (5) Choose an Off Time (15/30/45/60 seconds) with ◀ or ▶, and touch ENTER.
The menu off timer setting is completed.

NOTE

- The display time of the FineContrast menu remains unchanged.

Translucent

Set the transparency for menu display using the following procedure.

- (1) Choose <Others> from the Adjustment menu, and touch ENTER.
- (2) Choose <Menu Settings> from the <Others> menu, and touch ENTER.
- (3) Choose <Translucent> from the <Menu Settings> menu, and touch ENTER.
The <Translucent> menu appears.
- (4) Adjust the transparency for menu display with ◀ or ▶, and touch ENTER.
The transparency setting is completed.

2-10 Viewing Information/Setting Language

• To check settings, usage time, etc. [Information]

This function allows you to check settings, model name, serial number, and usage time of the monitor.

- (1) Choose <Information> from the Adjustment menu, and touch ENTER.
The <Information> menu appears.
- (2) Then, touch ENTER to check settings, etc.

• To set a language to be displayed [Language]

Select the Adjustment menu language.

Selectable languages

English/German/French/Spanish/Italian/Swedish/Japanese/Simplified Chinese/
Traditional Chinese

- (1) Choose <Language> menu from the Adjustment menu, and touch ENTER.
The <Language> menu appears.
- (2) Choose a language with ▲ / ▼ / ◀ / ▶, and touch ENTER.
The language setting is completed.

NOTE

- The usage time is not always “0” when you purchase the monitor due to factory inspection.

2-11 Resumption of Default Setting

• To reset color adjustment [Reset]

The hue in the color mode currently set will revert to the default settings (factory settings).

- (1) Choose <Color> from the Adjustment menu, and touch ENTER.
- (2) Choose <Reset> from the <Color> menu and touch ENTER.
The <Reset> menu appears.
- (3) Select <Reset> with Δ or ∇ , and touch ENTER.
The reset operation is completed.

• To reset all settings [Reset]

Reset all adjustments/settings to the factory default settings.

- (1) Choose <Others> from the Adjustment menu, and touch ENTER.
- (2) Choose <Reset> from the <Others> menu, and touch ENTER.
The <Reset> menu appears.
- (3) Select <Reset> with Δ or ∇ , and touch ENTER.
The reset operation is completed.

NOTE

- For default settings, refer to “Main default settings (factory settings)” on page 31.

Chapter 3 Connecting Cables

3-1 Connecting Two PCs to the Monitor

Two PCs can be connected to the monitor through the two DVI-I connectors on the back of the monitor.

Connection examples

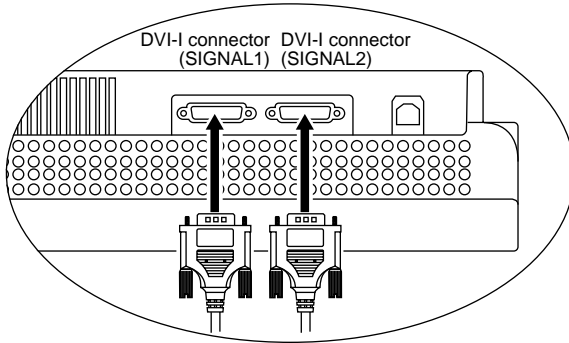

		SIGNAL1		SIGNAL2		
Example 1	Digital	DVI	Signal cable (supplied FD-C39) 	Signal cable (supplied FD-C16) 	D-sub mini 15-pin	Analog
Example 2	Analog	D-sub mini 15-pin	Signal cable (FD-C16 option) 	Signal cable (supplied FD-C16) 	D-sub mini 15-pin	Analog
Example 3	Digital	DVI	Signal Cable (FD-C39 option) 	Signal cable (supplied FD-C39) 	DVI	Digital

Selecting input signal

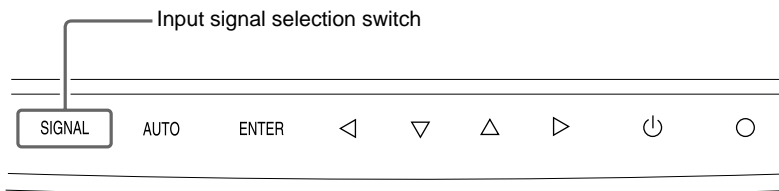

Switch the input signal with SIGNAL. Input signal switches each time SIGNAL is touched. When the signal is switched, the active signal type (Signal 1 or 2/ Analog or Digital) appears at the top right corner of the screen for two seconds.

● **To set priority of PC to be displayed [Input Priority]**

When two PCs are connected, either one can be displayed preferentially. The monitor senses the input signal regularly. When the signal that is given priority with the <Input Priority> setting is input, signal input switches automatically to the prior signal.

Priority setting	Function
1 Signal 1, input from DVI-I connector	The priority input setting functions in the following cases. <ul style="list-style-type: none"> • When the monitor is turned on • When the Signal 1 status changes even when Signal 2 is displayed
2 Signal 2, input from DVI-I connector	The priority input setting functions in the following cases. <ul style="list-style-type: none"> • When the monitor is turned on • When the Signal 2 status changes even when Signal 1 is displayed
Manual	The monitor does not detect the PC's signals automatically. Select an active input signal with SIGNAL.

[Procedure]

- (1) Choose <Others> from the Adjustment menu, and touch ENTER.
- (2) Choose <Input Priority> from the <Others> menu, and touch ENTER.
The <Input Priority> menu appears.
- (3) Select "1" or "2" or "Manual" with ◀ or ▶, and touch ENTER.
The Input Priority setting is completed.

3-2 Connecting Peripheral USB Devices

This monitor has a hub compatible with USB. Connected to a PC compatible with USB or another USB hub, this monitor functions as a USB hub allowing connection to peripheral USB devices.

- **Required System Environment**
 - (1) A PC equipped with a USB port or another USB hub connected to a USB compatible PC
 - (2) Windows 98/Me/2000/XP or Mac OS 8.5.1 or later
 - (3) EIZO USB cable (MD-C93)
- **Connection Procedure (Setup of USB Function)**
 - (1) Connect the monitor first to a PC using the signal cable, and run the PC.
 - (2) Connect the supplied USB cable between the downstream USB port of a USB compatible PC (or another USB hub) and the monitor's upstream USB port.
 - (3) When the USB function setup is completed, the monitor functions as a USB hub allowing connection to various peripheral USB devices through its downstream USB ports.

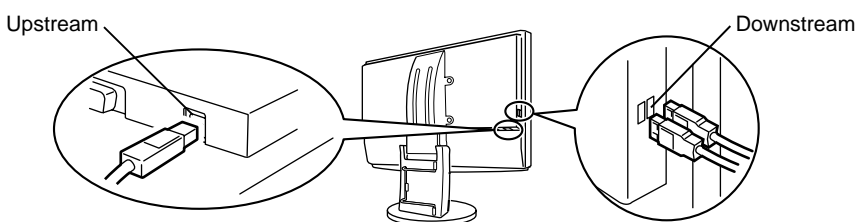

The USB function is set up automatically upon connection of the USB cable.

NOTE

- Power-saving function
When "1" or "2" is selected for <Input Priority>, the monitor's power-saving function works only when the two PCs are in the power-saving mode.
- When only one PC is connected, the input signal is detected automatically regardless of whether the input signal 1 or 2 has priority.

Attention

- This monitor may not work depending on PC, OS or peripheral devices to be used.
For USB compatibility of peripheral devices, contact their manufactures.
- If the monitor is in the power saving mode, or if the monitor is connected to the power outlet with the monitor turned off, all the devices connected to the USB ports (upstream and downstream) work. Therefore, power consumption of the monitor varies with connected devices even in the power saving mode.

Chapter 4 Troubleshooting

If a problem still remains after applying the suggested remedies, contact your local dealer.

- No-picture problems → See No.1 - No.2.
- Imaging problems → See No.3 - No.14.
- Other problems → See No.15 - No.18.
- USB problems → See No.19 - No.20.

Problems	Possible cause and remedy
<p>1. No picture</p> <ul style="list-style-type: none"> • Power indicator does not light. 	<ul style="list-style-type: none"> • Check whether the power cord is connected correctly. • Touch 
<ul style="list-style-type: none"> • Power indicator is lighting blue. • Power indicator is lighting yellow. 	<ul style="list-style-type: none"> • Check gain setting. • Switch the input signal with SIGNAL. • Operate the mouse or keyboard. • Turn on the PC.
<p>2. The message below appears.</p> <ul style="list-style-type: none"> • This message appears when no signal is input. <div data-bbox="312 864 635 1032" data-label="Image"> <pre> Signal Check ----- Signal 1 fH: 0.0kHz fV: 0.0Hz </pre> </div>	<p>This message appears when the signal is not input correctly even when the monitor functions properly.</p> <ul style="list-style-type: none"> • The message shown left may appear, because some PCs do not output the signal soon after power-on. • Check whether the PC is turned on. • Check whether the signal cable is connected properly. • Switch the input signal with SIGNAL.
<ul style="list-style-type: none"> • The message below shows that the input signal is out of the specified frequency range. (Such signal frequency is displayed in red.) Example: <div data-bbox="312 1178 635 1346" data-label="Image"> <pre> Signal Error ----- Signal 1 fD: 165.0MHz fH: 75.0kHz fV: 60.0Hz </pre> </div>	<ul style="list-style-type: none"> • Select an appropriate display mode using the graphics board's utility software. Refer to the manual of the graphics board for details.
<p>3. Display position is incorrect.</p> <div data-bbox="400 1408 549 1527" data-label="Image"> </div>	<ul style="list-style-type: none"> • Adjust image position so that it is displayed properly within the display area using the <Position> adjustment. • If the problem persists, use the graphics board's utility software if available to change the display position.
<p>4. Screen image displayed is smaller or larger than the actual screen image.</p>	<ul style="list-style-type: none"> • Adjust the resolution using <Resolution> so that the input signal resolution equals the resolution in the resolution adjustment menu.
<p>5. Vertical bars appear on the screen or a part of the image is flickering.</p> <div data-bbox="317 1715 632 1834" data-label="Image"> </div>	<ul style="list-style-type: none"> • Adjust using <Clock>.
<p>6. Whole screen is flickering or blurring.</p> <div data-bbox="400 1895 549 2013" data-label="Image"> </div>	<ul style="list-style-type: none"> • Adjust using <Phase>.

Problems	Possible cause and remedy
7. Characters are blurred.	<ul style="list-style-type: none"> Adjust using <Smoothing>.
8. Upper part of the screen is distorted as shown below. 	<ul style="list-style-type: none"> This is caused when both composite sync (X-OR) signal and separate vertical sync signal are input simultaneously. Select either composite signal or separate signal.
9. The screen is too bright or too dark.	<ul style="list-style-type: none"> Adjust <Brightness>. (The LCD monitor backlight has a fixed life span. When the screen becomes dark or begins to flicker, contact your local dealer.)
10. Afterimages appear.	<ul style="list-style-type: none"> Use a screen saver or off timer function for a long-time image display. Afterimages are particular to LCD monitors. Avoid displaying the same image for a long time.
11. Green/red/blue/white dots or defective dots remain on the screen.	<ul style="list-style-type: none"> This is due to LCD panel characteristics and is not a failure.
12. Interference patterns or fingerprints remain on the screen.	<ul style="list-style-type: none"> Leave the monitor with a white or black screen. The symptom may disappear.
13. Noise appears on the screen.	<ul style="list-style-type: none"> Select 1 to 4 in <Signal Filter> from the <Screen> menu to change the mode. When entering the signals of HDCP system, the normal images may not be displayed immediately. When utilizing [Enhancer] function, the normal images may not be displayed since the display gradation abnormality or noise may occur on the screen depending on the display pattern.
14. Characters are pigmentized.	<ul style="list-style-type: none"> When [OutlineEnhancer] is set excessively, the characters on the screen may be affected to color.
15. The <Smoothing> icon on the Adjustment menu <Screen> cannot be selected.	<ul style="list-style-type: none"> <Smoothing> is disabled when the screen is displayed in the following conditions; <ul style="list-style-type: none"> The resolution is 1920 x 1200. The screen size is set to Normal.
16. The Main menu of Adjustment menu does not start.	<ul style="list-style-type: none"> Check for Adjustment Lock function. Check whether the FineContrast menu is running. (Refer to "Simple adjustment [FineContrast mode]" on page 14.)
17. The FineContrast menu does not start.	<ul style="list-style-type: none"> Check whether the Main menu of Adjustment menu is running. (Refer to "Advanced Adjustments [Adjustment menu]" on page 15.)
18. The AUTO switch does not function.	<ul style="list-style-type: none"> The AUTO switch does not function when digital signal is input. Check whether the buttons are locked.
19. PC does not boot or connected peripheral devices do not work.	<ul style="list-style-type: none"> Check whether the USB cable is connected correctly. Change the USB port to another one. If the PC or peripheral devices works correctly by changing the USB port, contact your local dealer. (Refer to the manual of the PC for details.) Please perform the followings to check the status. <ul style="list-style-type: none"> Reboot the PC. Connect the PC and peripheral devices directly. If the PC or peripheral devices works correctly without connecting each other via the monitor (working as a USB hub), please contact your local dealer.
20. USB function cannot be set up.	<ul style="list-style-type: none"> Check whether the USB cable is connected correctly. Check whether the PC and OS are USB compliant. (For USB compliance of the respective devices, consult their manufacturers.) Check the PC's BIOS setting for USB when using Windows 98/Me/2000/XP. (Refer to the manual of the PC for details.)

Chapter 5 Reference

5-1 Attaching an Arm

The stand can be removed and replaced with an arm (or another stand) to be attached to the monitor. Use an arm or stand of EIZO option.

[Attaching]

1 Lay the LCD monitor on a soft cloth spread over on a stable surface with the panel surface facing down.

2 Remove the stand. (Prepare a screwdriver.)

Unscrew the four screws securing the unit and the stand with the screwdriver.

3 Attach the monitor to the arm or stand.

Secure the monitor to the arm or stand using the screws specified in the user's manual of the arm or stand.

- Clearance between the screw holes when attach an arm or stand:
In case of 100mm × 100mm

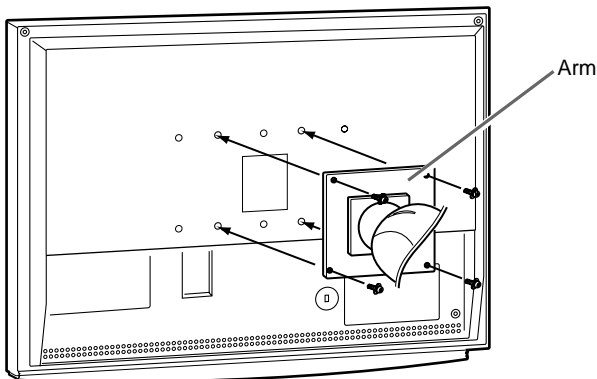

- Clearance between the screw holes when attach an arm or stand:
In case of 200mm × 100mm

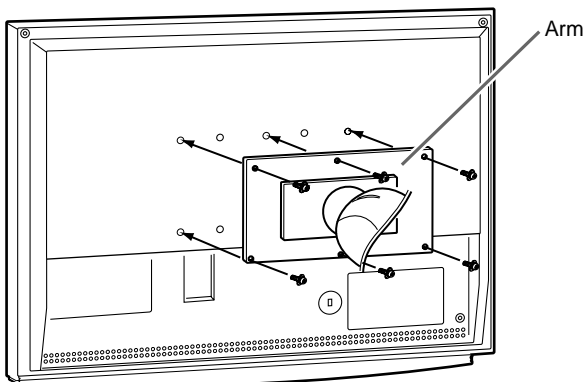

Attention

- When attaching an arm or stand, follow the instructions of their user's manual.
- When using another manufacturer's arm or stand, confirm the following in advance and select one conforming to the VESA standard. Use M4 × 12 mm screws supplied with this monitor.
 - Clearance between the screw holes:
 - 100 mm × 100 mm
 - 200 mm × 100 mm
 - Thickness of plate: 2.6 mm
 - Strong enough to support weight of the monitor unit (except the stand) and attachments such as cables.
- Attach an arm or stand to meet the following tilt angles of the monitor.
 - Up 60 degrees, down 45 degrees (Horizontal display)
- Connect the cables after attaching an arm.

5-2 Cleaning

Clean the monitor periodically to keep the monitor clean and extend its life.

Cabinet

Clean the cabinet with a soft cloth dampened with little mild detergent.

LCD Panel

- Clean the LCD panel with a soft cloth such as cotton cloth or lens cleaning paper.
- Remove persistent stains gently with a cloth dampened with little water, and then clean the LCD panel again with a dry cloth for better finishing.

Attention

- Never use any solvents or chemicals, such as thinner, benzene, wax, alcohol, and abrasive cleaner, which may damage the cabinet or LCD panel.

NOTE

- Optional ScreenCleaner is recommended for cleaning the panel surface.

5-3 Specifications

LCD Panel	24.1-inch (610 mm) TFT color LCD with anti-glare hard coating Viewing angle: Vertical 178°, Horizontal 178°(CR:10 or more)
Dot Pitch	0.270mm
Horizontal Scan Frequency	Analog: 24-94kHz (Automatic) Digital: 31-76kHz
Vertical Scan Frequency	Analog: 49-86Hz (Automatic) (1600 × 1200: 49-76Hz, 1920 × 1200: 49-61Hz) Digital: 59-61Hz (VGA TEXT: 69-71Hz) (1080p@50Hz: 49-51Hz)
Resolution	1920 dots × 1200 lines
Max. Dot Clock	Analog: 202.5MHz Digital: 162MHz
Max. Display Color	1677 million colors
Display Area (H × V)	518.4mm × 324.0mm
Power Supply	100-120 VAC ±10%, 50/60Hz 1.1A 200-240 VAC ±10%, 50/60Hz 0.55A
Power Consumption	Max.: 110W (with USB load) Min.: (normal mode) (without USB load): 100W Power saving mode: 2W or less (for single signal input) Power switch Off: 1W or less
Input Signal Connector	DVI-I connector (Applicable to HDCP) × 2
Analog Input Signal (Sync)	a) Separate, TTL, positive/ negative b) Composite, TTL, positive/ negative
Analog Input Signal (Video)	Analog, Positive (0.7Vp-p/75Ω)
Digital Signal Transmission System	TMDS (Single Link)
Video Signal Memory	Analog signal: 45 (preset: 30) Digital signal: 10 (preset: 0)
Plug & Play	VESA DDC 2B
Dimensions (Main unit)	566mm (22.3 inch)(W) × 358.7-480mm (14.1-189.9 inch)(H) × 230mm (9.1 inch)(D)
Dimensions (without Stand)	566mm (22.3 inch)(W) × 396mm (15.5 inch)(H) × 85mm (3.4 inch)(D)
Weight (Main unit)	10.2kg (22.4 lbs)
Weight (without Stand)	7.8kg (17.2 lbs)
Environmental Conditions	Operating temperature: 0 °C - 35 °C Storage temperature: -20 °C - 60 °C Relative humidity: 30% - 80% (no condensation)
USB Standard	USB Specification Revision 2.0
USB Port	Upstream port × 1 Downstream port × 2

Main default settings (factory settings)

		Analog Input	Digital Input
Smoothing		3	
FineContrast Mode		Custom	
PowerManager		VESA DPMS	DVI DMPM
Screen Size		Full Screen	
Input Priority		1	
Off Timer		Disable	
Menu Settings	Menu Size	Normal	
	Menu Off Timer	45sec	
Beep		On	
Language		English	

Outside Dimensions

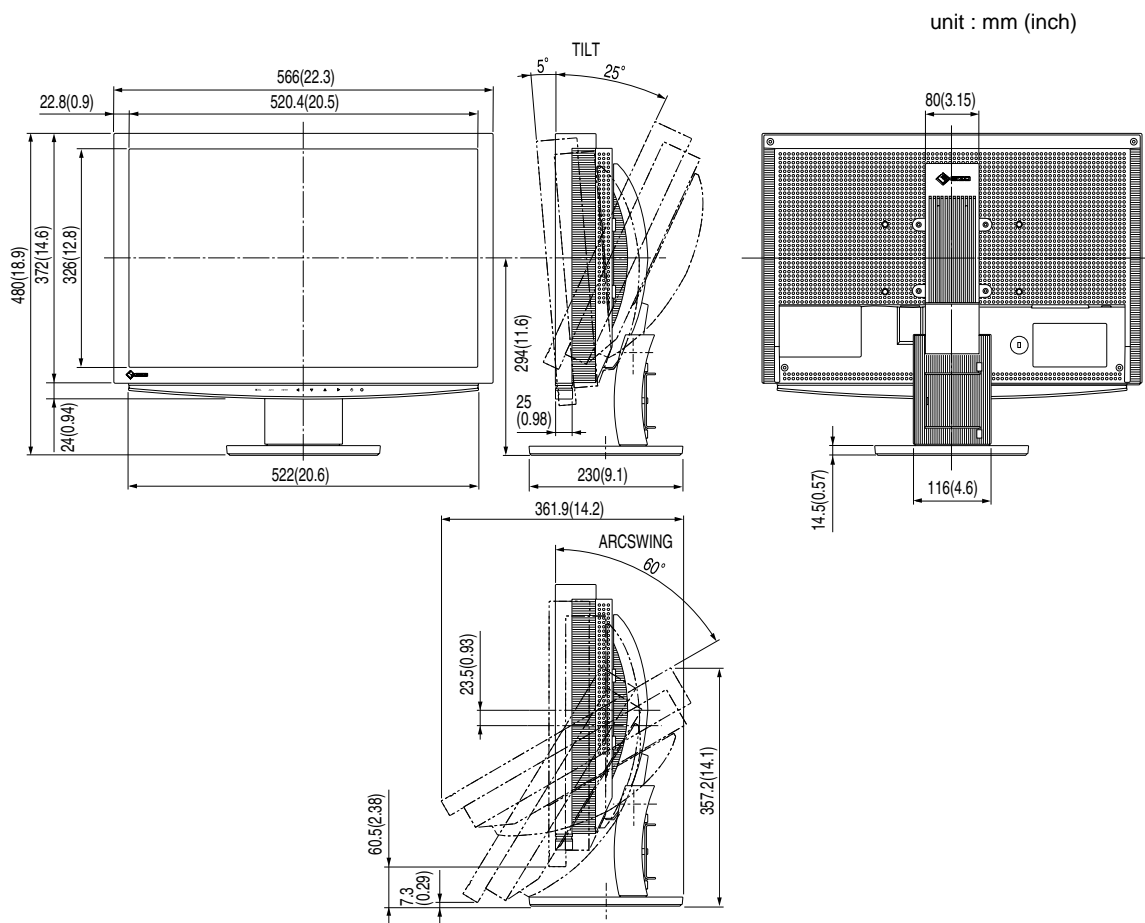

Connector Pin Assignment

- DVI-I connector

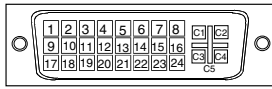

Pin No.	Signal	Pin No.	Signal	Pin No.	Signal
1	TMDS Data 2-	11	TMDS Data1/3 Shield	21	NC*
2	TMDS Data 2+	12	NC*	22	TMDS Clock shield
3	TMDS Data2/4 Shield	13	NC*	23	TMDS Clock+
4	NC*	14	+5V Power	24	TMDS Clock-
5	NC*	15	Ground (return for +5V, Hsync and Vsync)	C1	Analog Red
6	DDC Clock (SCL)	16	Hot Plug Detect	C2	Analog Green
7	DDC Data (SDA)	17	TMDS Data0-	C3	Analog Blue
8	Analog Vertical Sync	18	TMDS Data0+	C4	Analog Horizontal Sync
9	TMDS Data1-	19	TMDS Data0/5 Shield	C5	Analog Ground (analog R,G,&B return)
10	TMDS Data1+	20	NC*		

(NC*: No Connection)

- USB port

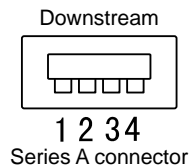
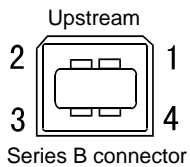

Contact No.	Signal	Remarks
1	VCC	Cable power
2	- Data	Serial data
3	+ Data	Serial data
4	Ground	Cable ground

Option List

Cleaning Kit	EIZO ScreenCleaner
Signal Cable	FD-C16 FD-C39

5-4 Glossary

Clock

The analog input monitor needs to reproduce a clock of the same frequency as the dot clock of the graphics system in use, when the analog input signal is converted to a digital signal for image display.

This is called clock adjustment. If the clock pulse is not set correctly, some vertical bars appear on the screen.

DVI (Digital Visual Interface)

DVI is a digital interface standard. DVI allows direct transmission of the PC's digital data without loss.

This adopts the TMDS transmission system and DVI connectors. There are two types of DVI connectors. One is a DVI-D connector for digital signal input only. The other is a DVI-I connector for both digital and analog signal inputs.

DVI DMPM (DVI Digital Monitor Power Management)

DVI DMPM is a digital interface power-saving function. The "Monitor ON (operating mode)" and "Active Off (power-saving mode)" are indispensable for DVI DMPM as the monitor's power mode.

ContrastEnhancer

ContrastEnhancer functions to reproduce images with a taste of contrast by compensating the gamma value as well as controlling the backlight brightness and the gain level according to the image status.

Gain

This is used to adjust each color parameter for red, green and blue. An LCD monitor displays the color by the light passing through the panel color filter. Red, green and blue are the three primary colors. All the colors on the screen are displayed by combining these three colors. The color tone can be changed by adjusting the light intensity (volume) passing through each color's filter.

Gamma

Generally, the monitor brightness varies nonlinearly with the input signal level, which is called "Gamma Characteristic". A small gamma value produces a low-contrast image, while a large gamma value produces a high-contrast image.

HDCP (High-bandwidth Digital Contents Protection)

Digital signal coding system developed to copy-protect the digital contents, such as video, music, etc. This helps to transmit the digital contents safely by coding the digital contents sent via DVI terminal on the output side and decoding them on the input side.

Any digital contents cannot be reproduced if both of the equipments on the output and input sides are not applicable to HDCP system.

OutlineEnhancer

OutlineEnhancer functions to emphasize outline of the images by emphasizing the color difference between pixels composing the images. This may improve the texture of the material and its feel of the images.

On the contrary, it also functions to reproduce the images smoothly by gradating its outline.

Phase

Phase means the sampling timing to convert the analog input signal to a digital signal. Phase adjustment is made to adjust the timing. It is recommended that phase adjustment be made after the clock is adjusted correctly.

Range Adjustment

Range adjustment controls the signal output levels to display every color gradation. It is recommended that range adjustment be made before color adjustment.

Resolution

The LCD panel consists of numerous pixels of specified size, which are illuminated to form images. This monitor consists of 1920 horizontal pixels and 1200 vertical pixels. At a resolution of 1920 x 1200, all pixels are illuminated as a full screen (1:1).

sRGB (Standard RGB)

International standard for “color reproduction and color space” among peripheral devices (such as monitors, printers, digital cameras, scanners). sRGB allows Internet users to closely match colors as a simple color matching means for the Internet use.

Temperature

Color temperature is a method to measure the white color tone, generally indicated in degrees Kelvin. The screen becomes reddish at a low temperature, and bluish at a high temperature, like the flame temperature.

5000K: Slightly reddish white

6500K: Warm white like paper white

9300K: Slightly bluish white

TMDS (Transition Minimized Differential Signaling)

A signal transmission system for digital interface.

VESA DPMS (Video Electronics Standards Association - Display Power Management Signaling)

VESA provides the standardization of signals from PC (graphics board) for power saving of PC monitors. DPMS defines the signal status between PC and monitor.

5-5 Preset Timing

The following table shows factory preset video timing (for analog signal only).

Mode	Dot clock		Frequency	Polarity
			Horizontal: kHz Vertical: Hz	
VGA 640x480@60Hz	25.2 MHz	Horizontal	31.47	Negative
		Vertical	59.94	Negative
VGA 720x400@70Hz	28.3 MHz	Horizontal	31.47	Negative
		Vertical	70.09	Positive
Macintosh 640x480 @67Hz	30.2 MHz	Horizontal	35.00	Negative
		Vertical	66.67	Negative
Macintosh 832x624 @75Hz	57.3 MHz	Horizontal	49.72	Negative
		Vertical	74.55	Negative
Macintosh 1152x870 @75Hz	100.0 MHz	Horizontal	68.68	Negative
		Vertical	75.06	Negative
Macintosh 1280x960 @75Hz	126.2 MHz	Horizontal	74.76	Positive
		Vertical	74.76	Positive
VESA 640x480@72Hz	31.5 MHz	Horizontal	37.86	Negative
		Vertical	72.81	Negative
VESA 640x480@75Hz	31.5 MHz	Horizontal	37.50	Negative
		Vertical	75.00	Negative
VESA 640x480@85Hz	36.0 MHz	Horizontal	43.27	Negative
		Vertical	85.01	Negative
VESA 800x600@56Hz	36.0 MHz	Horizontal	35.16	Positive
		Vertical	56.25	Positive
VESA 800x600@60Hz	40.0 MHz	Horizontal	37.88	Positive
		Vertical	60.32	Positive
VESA 800x600@72Hz	50.0 MHz	Horizontal	48.08	Positive
		Vertical	72.19	Positive
VESA 800x600@75Hz	49.5 MHz	Horizontal	46.88	Positive
		Vertical	75.00	Positive
VESA 800x600@85Hz	56.3 MHz	Horizontal	53.67	Positive
		Vertical	85.06	Positive
VESA 1024x768 @60Hz	65.0 MHz	Horizontal	48.36	Negative
		Vertical	60.00	Negative
VESA 1024x768 @70Hz	75.0 MHz	Horizontal	56.48	Negative
		Vertical	70.07	Negative
VESA 1024x768 @75Hz	78.8 MHz	Horizontal	60.02	Positive
		Vertical	75.03	Positive
VESA 1024x768 @85Hz	94.5 MHz	Horizontal	68.68	Positive
		Vertical	85.00	Positive
VESA 1152x864 @75Hz	108.0 MHz	Horizontal	67.50	Positive
		Vertical	75.00	Positive
VESA 1280x960 @60Hz	108.0 MHz	Horizontal	60.00	Positive
		Vertical	60.00	Positive
VESA 1280x1024 @60Hz	108.0 MHz	Horizontal	63.98	Positive
		Vertical	60.02	Positive
VESA 1280x1024 @75Hz	135.0 MHz	Horizontal	79.98	Positive
		Vertical	75.03	Positive
VESA 1280x1024 @85Hz	157.5 MHz	Horizontal	91.15	Positive
		Vertical	85.03	Positive
VESA 1600x1200 @60Hz	162.0 MHz	Horizontal	75.00	Positive
		Vertical	60.00	Positive
VESA 1600x1200 @65Hz	175.0 MHz	Horizontal	81.30	Positive
		Vertical	65.00	Positive
VESA 1600x1200 @70Hz	189.0 MHz	Horizontal	87.50	Positive
		Vertical	70.00	Positive
VESA 1600x1200 @75Hz	202.5 MHz	Horizontal	93.80	Positive
		Vertical	75.00	Positive
VESA CVT 1680x1050	146.3 MHz	Horizontal	65.29	Negative
		Vertical	59.95	Positive

Attention

- Display position may be deviated depending on the PC connected, which may require screen adjustment using Adjustment menu.
- If a signal other than those listed in the table is input, adjust the screen using the Adjustment menu. However, screen display may still be incorrect even after the adjustment.
- When interlace signals are used, the screen cannot be displayed correctly even after screen adjustment using the Adjustment menu.

VESA CVT 1920x1200	193.3 MHz	Horizontal	74.56	Negative
		Vertical	59.89	Positive
VESA CVT RB 1920x1200	154.0 MHz	Horizontal	74.04	Positive
		Vertical	59.95	Negative

Applicable to White/Silver and Black cabinet only.



Congratulations!

The display you have just purchased carries the TCO'03 Displays label. This means that your display is designed, manufactured and tested according to some of the strictest quality and environmental requirements in the world. This makes for a high performance product, designed with the user in focus that also minimizes the Impact on our natural environment.

Some of the features of the TCO'03 Display requirements:

Ergonomics

- Good visual ergonomics and image quality in order to improve the working environment for the user and to reduce sight and strain problems. Important parameters are luminance, contrast, resolution, reflectance, colour rendition and image stability.

Energy

- Energy-saving mode after a certain time - beneficial both for the user and environment
- Electrical safety

Emissions

- Electromagnetic fields
- Noise emissions

Ecology

- The products must be prepared for recycling and the manufacturer must have a certified environmental management system such as EMAS or ISO 14000
- Restrictions on
 - chlorinated and brominated flame retardants and polymers
 - heavy metals such as cadmium, mercury and lead.

The requirements included in this label have been developed by TCO Development in co-operation with scientists, experts, users as well as manufacturers all over the world. Since the end of the 1980s TCO has been involved in influencing the development of IT equipment in a more user-friendly direction. Our labeling system with displays in 1992 and is now requested by users and IT-manufacturers all over the world.

**For more information, please visit
www.tcodevelopment.com**

For U.S.A. , Canada, etc. (rated 100-120 Vac) Only

FCC Declaration of Conformity

We, the Responsible Party

EIZO NANAOTECHNOLOGIES INC.

5710 Warland Drive, Cypress, CA 90630

Phone: (562) 431-5011

declare that the product

Trade name: EIZO

Model: FlexScan S2411W-U

is in conformity with Part 15 of the FCC Rules. Operation of this product is subject to the following two conditions: (1) this device may not cause harmful interference, and (2) this device must accept any interference received, including interference that may cause undesired operation.

This equipment has been tested and found to comply with the limits for a Class B digital device, pursuant to Part 15 of the FCC Rules. These limits are designed to provide reasonable protection against harmful interference in a residential installation. This equipment generates, uses, and can radiate radio frequency energy and, if not installed and used in accordance with the instructions, may cause harmful interference to radio communications. However, there is no guarantee that interference will not occur in a particular installation. If this equipment does cause harmful interference to radio or television reception, which can be determined by turning the equipment off and on, the user is encouraged to try to correct the interference by one or more of the following measures.

- * Reorient or relocate the receiving antenna.
- * Increase the separation between the equipment and receiver.
- * Connect the equipment into an outlet on a circuit different from that to which the receiver is connected.
- * Consult the dealer or an experienced radio/TV technician for help.

Changes or modifications not expressly approved by the party responsible for compliance could void the user's authority to operate the equipment.

Note

Use the attached specified cable below or EIZO signal cable with this monitor so as to keep interference within the limits of a Class B digital device.

- AC Cord
- Shielded Signal Cable (DVI - D-sub mini 15-pin, the enclosed signal cable)

Canadian Notice

This Class B digital apparatus complies with Canadian ICES-003.

Cet appareil numérique de la classe B est conforme à la norme NMB-003 du Canada.

Hinweise zur Auswahl des richtigen Schwenkarms für Ihren Monitor

Dieser Monitor ist für Bildschirmarbeitsplätze vorgesehen. Wenn nicht der zum Standardzubehör gehörige Schwenkarm verwendet wird, muss statt dessen ein geeigneter anderer Schwenkarm installiert werden. Bei der Auswahl des Schwenkarms sind die nachstehenden Hinweise zu berücksichtigen:

Der Standfuß muß den nachfolgenden Anforderungen entsprechen:

- a) Der Standfuß muß eine ausreichende mechanische Stabilität zur Aufnahme des Gewichtes vom Bildschirmgerät und des spezifizierten Zubehörs besitzen. Das Gewicht des Bildschirmgerätes und des Zubehörs sind in der zugehörigen Bedienungsanleitung angegeben.
- b) Die Befestigung des Standfusses muß derart erfolgen, daß die oberste Zeile der Bildschirmanzeige nicht höher als die Augenhöhe eines Benutzers in sitzender Position ist.
- c) Im Fall eines stehenden Benutzers muß die Befestigung des Bildschirmgerätes derart erfolgen, daß die Höhe der Bildschirmmitte über dem Boden zwischen 135 – 150 cm beträgt.
- d) Der Standfuß muß die Möglichkeit zur Neigung des Bildschirmgerätes besitzen (max. vorwärts: 5°, min. nach hinten $\geq 5^\circ$).
- e) Der Standfuß muß die Möglichkeit zur Drehung des Bildschirmgerätes besitzen (max. $\pm 180^\circ$). Der maximale Kraftaufwand dafür muß weniger als 100 N betragen.
- f) Der Standfuß muß in der Stellung verharren, in die er manuell bewegt wurde.
- g) Der Glanzgrad des Standfusses muß weniger als 20 Glanzeinheiten betragen (seidenmatt).
- h) Der Standfuß mit Bildschirmgerät muß bei einer Neigung von bis zu 10° aus der normalen aufrechten Position kippstabil sein.

Hinweis zur Ergonomie :

Dieser Monitor erfüllt die Anforderungen an die Ergonomie nach ISO13406-2 mit dem Videosignal, 1920 × 1200, RGB analog, 0,7 Vp-p und mindestens 60,0 Hz Bildwiederholfrequenz, non interlaced. Weiterhin wird aus ergonomischen Gründen empfohlen, die Grundfarbe Blau nicht auf dunklem Untergrund zu verwenden (schlechte Erkennbarkeit, Augenbelastung bei zu geringem Zeichenkontrast.)

„Maschinenlärminformations-Verordnung 3. GPSGV:

Der höchste Schalldruckpegel beträgt 70 dB(A) oder weniger gemäss EN ISO 7779“

Nicht für Bildschirm - Arbeitsplätze geeignet



EIZO NANA O CORPORATION

153 Shimokashiwano, Hakusan, Ishikawa 924-8566 Japan
Phone: +81 76 277 6792 Fax: +81 76 277 6793

EIZO NANA O TECHNOLOGIES INC.

5710 Warland Drive, Cypress, CA 90630, U.S.A.
Phone: +1 562 431 5011 Fax: +1 562 431 4811

EIZO EUROPE AB

Lovangsvagen 14 194 61, Upplands Väsby, Sweden
Phone: +46 8 590 80 000 Fax: +46 8 590 91 575

EIZO NANA O AG

Moosacherstrasse 6, Au CH - 8820 Wadenswil, Switzerland
Phone: +41-0-44 782 24 40 Fax: +41-0-44 782 24 50

Avnet Technology Solutions GmbH

Lötscher Weg 66, D-41334 Nettetal, Germany
Phone: +49 2153 733-400 Fax: +49 2153 733-483

<http://www.eizo.com>



2nd Edition-April, 2007

03V22030B1
(U.M-S2411W-U)